

Russian Academy of Sciences  
Institute of Philosophy

# Philosophy: Theory and Practice

Moscow  
2013

УДК 100  
ББК 87  
Р 57

**Editors**

V. Sharova, E. Trufanova, A. Yakovleva

P 57     **Philosophy: Theory and Practice / Russian Academy of Sciences, Institute of Philosophy; Ed.: V. Sharova, E. Trufanova, A. Yakovleva.** – М. : ИФ РАН, 2013. – 268 p. ; 20 см. – 500 экз. – ISBN 978-5-9540-0258-4.

This book is a collection of papers presented at the XXIII World Congress of Philosophy (4–10 August, 2013, Athens, Greece) by research fellows and affiliated students and postgraduates of the Institute of Philosophy of the Russian Academy of Sciences. The papers represent a broad variety of philosophical subjects lying within such disciplines as epistemology, history of philosophy, philosophy of science, ethics, social and political philosophy, logic etc.

ISBN 978-5-9540-0258-4

© Athors, 2013

© Institute of Philosophy RAS, 2013

## CONTENTS

<i>Guseynov A.</i> Philosophy as an Ethical Project.....	5
--	---

### I. Epistemology and Logic

<i>Lektorskiy V.</i> Rationality in Contemporary Culture .....	22
<i>Avtonomova N.</i> Roman Jakobson 's Life in Language and the Epistemological Potential of His Idea of Structure .....	28
<i>Beskova I.</i> Human Embodiment as a Complex Phenomenon.....	32
<i>Kanaev I.</i> Awareness of the Body as a Form of Self-Consciousness.....	37
<i>Kasavin I.</i> Underdetermination of Knowledge by Context: A Challenge for Social Epistemology.....	43
<i>Kasavin I.</i> What Kind of Realism Does Social Epistemology Assume? .....	49
<i>Morkina J.</i> Philosophical Concepts in Consciousness: Transcendental in Dynamics .....	63
<i>Pavlov S.</i> Extension of Definitional Domain for Truth and Falsehood Operators.....	69
<i>Pruzhinin B.</i> Russian Philosophical Tradition as European: Epistemological Style of Intellectual Culture .....	76
<i>Smirnova N.</i> Naturalistic Challenge to Contemporary Epistemology .....	81
<i>Trufanova E.</i> Personal Identity in the Age of Mass Communication .....	87

### II. Philosophy of Science

<i>Stepin V.</i> The Historic Types of Scientific Rationality .....	91
<i>Gorokhov V.</i> Galileo Galilei as Philosopher of Technology and Technology Assessment Expert.....	102
<i>Liseev I.</i> Life Sciences in Building of the World's Modern Scientific Picture .....	110
<i>Mamchur E.</i> Metaphysics and the Progress of Science .....	115

### III. Ethics

<i>Apressyan R.</i> Two Paradigms in Philosophy of Love .....	120
<i>Apressyan R.</i> Towards a Core Understanding of Morality.....	126
<i>Artemyeva O.</i> What Morality is About?.....	131
<i>Kravchenko A.</i> The Interpretations of Violence and Lie in European Philosophical Tradition: Immanuel Kant .....	138
<i>Zubets O.</i> Morality as Subjectness.....	142

#### **IV. Anthropology**

<i>Kasavina N.</i> The Basic Character of Existential Experience.....	148
<i>Korolev A.</i> What Hinders Development of Modern Man .....	153
<i>Pronin M.</i> Virtualistics as a Philosophical and Anthropological Turn in the Human Sciences.....	158
<i>Yudin B.</i> Boundaries of Individual Human Existence as Zones of Engineering Interventions.....	166

#### **V. Social and Political Philosophy**

<i>Chumakov A.</i> Globalization: Perspectives and Realities of Global Development.....	169
<i>Fedotova V.</i> Globalization as Megatrend and Local Modernization Trends.....	175
<i>Sharova V.</i> Gender Aspects of the Modern Left-Wing Politics: the Specifics of Russia .....	179
<i>Shchedrovitsky P.</i> The Problem of the Division of Labour in the Context of Philosophy of Activity/Tätigkeit.....	185
<i>Shevchenko V.</i> The Revolution of Spirit as a Category of Philosophy of History ....	195
<i>Yakovleva A.</i> Intellectual Work in the Context of Freedom and Alienation.....	201

#### **VI. History of Philosophy**

<i>Dolgov K.</i> The Philosopher and Philosophy in Plato's View.....	207
<i>Gadzhikurbanova P.</i> <i>Kathēkon</i> and <i>Katorthōma</i> in the Early Stoic Ethics .....	215
<i>Lebedev A.</i> Idealism in Early Greek Philosophy: the Case of Pythagoreans and Eleatics.....	220
<i>Stepanyants M.</i> Reflections on Metaphysics of Russian Culture.....	231

#### **VII. Students' Papers**

<i>Shchedrina I.</i> The Problem of the "Self" in the European Tradition: Casus of Malebranche.....	244
<i>Sabancheev R.</i> The Annales School in the Context of European Philosophical-Methodological Traditions.....	250
<i>Shushkina A.</i> Rationalistic Doubt of Descartes and Montaigne's Skepticism as the Basis of Horkheimer's Criticism.....	255

#### **VIII. History of World Congresses of Philosophy**

<i>Shchedrina T.</i> Philosophical Congress as a Phenomenon of Cultural-Historical Communication .....	260
Athors.....	266

*A. A. Guseynov*

## **PHILOSOPHY AS AN ETHICAL PROJECT**

Philosophy is often understood in terms of public benefit as being synonymous with its application to other domains of public life such as politics, economics, education etc. The question I would like to raise is of an altogether different nature – namely, it is the question of whether philosophy can be seen as having any public or social value per se, before there is any further thought of application or usage. In particular, it is the question of whether it contains anything universally significant – something that could make it of interest to anyone as seen in the context of one’s personal evolution. And in order to answer that question, first we have to find out what philosophy is to the philosophers themselves and how it benefits them.

\* \* \*

Ethics has traditionally been considered one of the main outlets of philosophy in public and social life. Philosophical ethics is also referred to as practical philosophy – as opposed to theoretical philosophy. It is also a major factor that makes philosophy interesting to the general public. Some try to distinguish between philosophy, which is perceived as theoretical philosophy per se, in the strictest sense of the word, and ethics as its mere application, or practical aspect. This distinction is obviously erroneous.

The division of philosophy into the domains of logic, physics and ethics has been known since antiquity. They remain the three cornerstones of philosophy to this day, even though the process of differentiation has continued throughout the entire history of philosophy, represented by dozens of specialised disciplines today – and indeed well-represented in our congress programme. This understanding of the subject of philosophy provides a full scope of approaches to human existence, which is viewed in one of its three main aspects, namely, the intellectual, the natural and the moral. Philosophy thus assumes the responsibility for the human world – not in the aspect of universal knowledge, but rather in that of establishing its cohesiveness and comprehending the internal affinity between the ability to cogitate, the necessity of nature and the freedom of action. Thus, when the question of the purpose of philosophy is answered by someone who points out its ability to teach an individual some rules that apply to cogitation, perception of the world and right behaviour, the answer is only partially correct, because it does not reflect the unique nature of philosophy. Its uniqueness and the special nature of its purpose are as follows: philosophy attempts to address human existence as a whole, bringing into view the unity of all of its three canons: the canon of thought (logic), the canon of knowledge (physics) and the canon of action (ethics). There is another important aspect related to the above.

The ancients did not merely introduce the division of philosophy into three spheres – they also discovered the internal relatedness between them, one that places ethics in the focal point. According to the imagery found in the works of Sextus Empiricus, if we liken philosophy to an egg, logic is the shell, physics is the white and ethics is the yolk. Should the metaphor involve a garden, logic is the fence, physics is the trees and ethics is the fruit; in case of a human body, logic is the skeleton, physics is flesh and ethics is the soul. This interpretation implies that ethics, albeit a domain of philosophy, also represents its very message – philosophy’s unifying purpose.

When we refer to the ethical dimension of philosophy, we have to distinguish between the following two aspects: ethics as part of philosophy and the ethical orientation of philosophy in general. In the former case, we understand ethics as a specific philosophical discipline that coexists with other disciplines (such as epistemology, ontology, aesthetics etc.)

In the latter case, philosophy itself is perceived as an ethical project. The correlation of these aspects is such that ethics explicitly defined as a discipline – ethics as the philosophy of morality – is the expression, extension and conclusion of the moral essence of philosophy in general. My idea is as follows: philosophy includes ethics and ends with ethics as a theory of morality because it was initially inspired and imbued by the moral message.

\* \* \*

Philosophy, which originated in Ancient Greece, was an expression of human yearning for virtue and perfection. An important fact to consider, to my mind, is that it was preceded by a heroic ethos. Historically (and, to a certain extent, also according to the views of the Ancient Greeks), philosophy became the alternative of the heroic ethos. Heroes are demigods born of unions between gods and mortals. They strive to prove their worth to their divine parents and stand among them as equals. However, they are incapable of it in the most direct and physical sense, for what stands between them and gods is the human nature they received from their human parents. Heroes challenge their own mortality. They attempt to compensate for the impossibility of physical immortality by attaining the immortality of glory – heroes stand out because of their strength, fearlessness and readiness to prove and defend their honour with their very life. Unable to reach godhood, they intend to compare to gods by performing great deeds and heroic feats. This is what the heroic ethos is all about. Philosophers have introduced a different understanding of human perfection – they associated it with verbal ability, intellectual capacity and knowledge.

When they first appeared in the cities of the Ancient Greece, philosophers caused wonder by their concern for abstract matters far removed from everyday necessities, their pondering of seemingly obvious issues, their loquaciousness, and their mental agitation, so alien to everybody else. But there was much more to them. The most amazing and implausible characteristic of these new characters was that they considered their issues and their intellectual agitation more important than social standing or prosperity – something they deemed to be of a secondary nature. Philosophers introduced a new set of values – a new ethos based

on knowledge and the intellect rather than might and power. Philosophy really was, and remains, a strange activity, in that it happens to be something much greater than merely another human activity out of many. Philosophy is something that one lives and breathes. The most astonishing thing about philosophers is that they pursue their abstract thoughts (superfluous from the point of view of everyday existence) with the kind of seriousness and dedication normally reserved for things that are more important than one's very life. To a philosopher, philosophy is a means of attaining one's human identity and manifesting one's subjectness. In one of his fragments (No. 101, Diels enumeration) Heraclitus says, "I searched myself" (ἐδίζησάμην ἐμωυτόν)<sup>1</sup>. He searched himself in the logos, the law and the mind of the Universe. The very same sentiment will be voiced again by Descartes in more than two thousand years in his *Discourse of the Method* – a description of the basics of his philosophy as well as a confession. At the end of the first part of his work, Descartes says that the method of cognition that he developed had stemmed from his decision "to study myself as well and to use all the powers of my mind to select paths which I should follow"<sup>2</sup>. Finally, relatively recently Heidegger answered the question of the nature and purpose of philosophy as follows: "It represents one of rare opportunities for autonomous and creative existence"<sup>3</sup>.

All this evidence is illustrative, but hardly unique. Virtually every prominent philosopher has uttered something to that effect. What they mean is that to philosophers themselves their philosophical pursuits have an ethical (moral) value, being also imperative to the formation of their personalities. Going back to the comparison with the heroic ethos, it can be said that unlike that ethos, with its message of becoming god-like and finding glory among men, the philosophical ethos orients one towards attaining one's own self, one's own mind, and receiving one's own approval from within.

Philosophers have appropriated the way towards perfection that they discovered as the name of their kind – the love for wisdom. Wisdom was defined as the truth – and not just any kind of truth, but truth in its

---

<sup>1</sup> *Fragments by Early Greek Philosophers* / Transl. by A. V. Lebedev. Part I. Moscow: Nauka, 1989, p. 15 [in Russian].

<sup>2</sup> Rene Descartes. *Compiled Works in 2 Volumes*. Vol. 1. Moscow: Mysl, 1989, p. 256 [in Russian].

<sup>3</sup> Martin Heidegger. *Country Path Conversations*. Moscow, 1991, p. 146 [in Russian].



perfect and divine expression – absolute and unsurpassable truth. Only the gods are wise – the lot of humankind is but to strive for wisdom. To be a philosopher means to yearn for beauty. Philosophical passion, or the love of wisdom, is known as thinking. Thinking is the subject of philosophy – something philosophy has introduced into human culture and keeps on supporting. Philosophers have associated human yearning for perfection, or the ideal and ultimate virtuous existence, with the fact that humans are rational beings and can only attain their authenticity through reason and reasoning, in a rational existence sanctioned by reason. Philosophy has introduced the conception that human yearning for virtue is actualised in the activity of thought and that an individual can only reach human perfection as a thinking being. In this interpretation, thinking isn't merely one of human abilities – it is also the highest and the best form of human existence.

\* \* \*

Human beings are living things; as such, they are driven by passion and considerations of their own personal gain, but they also have the necessity to transcend the passionate to reach the domain of cognition – otherwise their passion cannot be satisfied. Being an entity capable of cognition, the human being wishes to understand the world and strives for objective truth; however, there is also the need to exceed the bounds of cognition as it doesn't take their passions into consideration. Being capable of thought, humans try to fuse one with the other – passion and cognition, truth and personal gain. Philosophy elevates the human to the level of thinking – its purpose is to understand virtue as the truth and to wish for the truth as for virtue. There are two aspects of philosophical thinking that are of a particular interest to us – they distinguish it from scientific cognition.

The first aspect is reflected in the fact that philosophy transcends the limited and rigid scope of objective knowledge and constructs ideal and complete images of the world. I believe it was Russell who coined the witticism that science is something that you do know and philosophy is something that you do not. Indeed, philosophy has the tendency of going beyond the pale of exact knowledge. Its images of the world are developed up to the very final explanatory basics – in many cases they became

complete and self-contained systems. However, they always have an axiological kernel and present a view of the world as seen from the point of view of human aims. If we speak of the cognitive status of philosophical images of the world, they can, to a certain extent, be considered intellectual utopianism. We are not referring to specific utopian projects that were often constructed within its framework – utopianism is characteristic for philosophy in general as a specific cultural phenomenon. For instance, Plato is not being utopian just when he builds a model of an ideal state – first and foremost, his utopianism is manifested as constructing a domain of ideal phenomena. State utopianism is merely a derivative of the utopia of the world of ideas. We can notice similar tendencies in other great philosophers. Spinoza defines substance as the all-encompassing foundation of the world, Kant speaks of a noumenal world, Schopenhauer describes the world as will. All these utopian conceptions and images are, of course, mere philosophical fantasies, for no one has ever seen, and no one will ever see substance, or noumena, or Will, nor will their existence ever be proved by anyone. However, they are constructive enough and represent an important element of thought activity, being the extension and conclusion of cognition that makes it possible to receive intellectual answers to ethical aspirations of human beings. Spinoza's conception of substance is a direct result of his understanding of happiness. Kant finds the foundation of his moral law in the noumenal world. Schopenhauer's Will is expressed in his ethical pessimism. One cannot help thinking that implicit seeds of the ethical conclusions stemming from philosophical ontologies are present in the latter from the very start.

Ideal world images (models) result from the pursuit of absolute truth that is one of philosophy's primary characteristics. Philosophy implies and defines the attitude of a human being to the world that is comparable to that of the world's demiurge. It contains the idea of the sovereignty of human as a thinking being. This isn't merely expressed as every philosopher creating their own image of the world, but also as the claim to its singularity made by each and every one of them. Philosophy is pluralistic in principle. It exists as a multitude of philosophies, each of which is equal to itself. If there is any generation continuity in philosophy, it is negative for the most part, for every new philosophy established itself as negation of earlier philosophies – as explicit or implicit substantiation of its veracity as opposed to all the other philosophies.

This is where we approach the second aspect of philosophical thinking – namely, the fact that philosophical thinking is by definition critical towards extant life forms.

Thinking has a very special relation to the reality of human existence. It transports one into a different world – the ideal world – that exists alongside with the real world as reflected by the senses – parallel to it, as it were. If there's anything at all inside a human being that can be described as autonomous and based on nothing but itself, it's thinking. Once we become immersed in thought, we are no longer dealing with the real world, but rather an ideal representation thereof – we break the time and space boundaries of our existence. When we think, we can do or feel nothing else. A thought can only be continued with, or limited by, another thought; the process of thinking per se as studied from within in its internal logic is as endless as life itself. Obviously enough, a human being cannot think all the time. However, what concerns us now in this: once the thinking is over, it isn't over because the process has reached its end, but rather due to some external factor. The very process of thinking, or cogitating, cannot be stopped – it is as endless as its subject, the world.

This property of thinking (its self-negating continuity) is manifested the most fully in the experience of philosophical thought. A philosopher's thought does not begin where their predecessor left off – each time it starts from scratch, as if the philosopher were the first one to attempt it. And the object of thought is never some local problem, but rather the world itself, taken in its primordial nature. Intellectual utopia created by philosophical thought as a result of dissatisfaction with the real world becomes the reason for its criticism. The possibility of an ideal world makes us question the real world, the world in its present condition, and questioned it must be. The actual purpose of philosophy is to sharpen the mind enough to perceive the world critically, to sustain the necessity to ask questions, to propagate the culture of doubt that permits no complacency even if something very good has been reached because something even better is possible. Therefore, philosophy with its ideals and the resulting propensity for doubting any result achieved in any domain is always incongruous – just like a person who keeps talking when somebody else tries to perform an action. Hannah Arendt puts it very well indeed:

“There are no dangerous thoughts; thinking itself is dangerous”<sup>4</sup>. One of the key functions of philosophy within the intellectual dimension is to maintain the continuity of thinking as the expression and the guarantee of human longing for perfection. And each time it fulfils this function by constructing a new intellectual utopia, thus also providing the platform for a critical analysis of achieved results of cognition and practice.

\* \* \*

Philosophy combines its axiological approach to the world with the theoretical, or cognitive. This goes beyond the mere fact that philosophy studies the concepts of value and cognition and exposes their relatedness. It represents a union of the two in itself. Philosophy’s twofold purpose is to keep cognition within the field of human axiological vectors, which, in turn, are to be given a theoretically sound manifestation. This is the decisive factor that defines the place and the role of philosophy in society among other forms of culture.

Ever since Hegel there has been a tradition of distinguishing between the three main stages, or formations, in the development of European philosophy – the ancient period, the mediaeval period and the modern age. This division is very precise in the aspect that is of interest to us.

Pierre Hadot’s research demonstrates very well how ancient philosophy was cultivated as a special way of life and had a corresponding awareness of itself. It was a way of life in this very aspect – as a philosophy, a theory. Immersion into thought, concern for such issues as a human being’s goals, abilities and place in the world already represented a certain choice of a way of life. Socrates explained his inability to stop pondering such issues by claiming that he felt a special vocation – as though he was “made soldier by God himself.” Furthermore, theorising was perceived as a spiritual exercise – an exercise of will aimed at one’s transformation and purification. This explains certain traits of the ancient philosophical texts revealed by Pierre Hadot – namely, that their informative purpose was secondary to the formative; affinity to colloquial speech and actual circumstances was chosen over systematic

---

<sup>4</sup> Hannah Arendt. Cogitation and Considerations of Morality, in: *Responsibility and Judgement*. Moscow, 2013, p. 242 [in Russian].

impersonal narrative. Hence the use of dialogue, or the question-and-answer form, in philosophical contemplation – philosophical texts are seen as answers to certain questions; their purpose is not to express the truth, but to persuade the reader of its veracity, and they are addressed to a limited number of friends and apprentices – people capable of perceiving philosophical pursuits as spiritual experience. The personal, or spiritually formative and the interpersonal, or communicative, were the most prominent and even prevalent aspects of the ancient philosophy.

In other words, ancient philosophy was included in human lifestyle practices as a way of life. But there's much more to it. It also claimed the position of the most highly-evolved form of life and the final stage of the human pursuit of happiness. Tradition attributes the actual term “philosophy” to Pythagoras, likewise the distinction between three primary modes of human existence – sensuous, or hedonistic, active, or civic, and contemplative, or theorising. These modes constitute a hierarchy where the contemplative, or theorising, mode of existence is considered supreme. This is the very way of life of the philosophers, and it corresponds the most to the attributes of a certain self-sufficient and tireless condition that is equal to itself and most often associated with people's ideas of happiness, manifesting said attributes to the greatest extent. Every ancient school of philosophy developed its own version of philosophy that was perceived and practised as the perfect way of life. The hubris of philosophy that made it regard itself as the embodiment of perfection was the reason for its marginalisation and lack of any universal social role. It would be impossible for everybody to be a philosopher, after all – a philosopher in that highly specific school textbook sense, conforming to the ancient concept and criteria of a philosopher.

In the Middle Ages philosophy was assigned a secondary role. Its role in society during this epoch is usually defined as follows: “Philosophy is the serving girl of theology.” However, this is but one view of the issue – what we learn from this expression is that theology needed philosophy and used the intellectual arsenal of the latter for its own ends. There is another view, which concerns the question of why philosophy, with its view of itself as the highest manifestation of human wisdom, agreed to play a secondary part and became a slave of theology. I believe that the decisive role here was played by the following circum-

stance. In mediaeval society, the function performed by philosophy in antiquity – namely, that of a spiritually conscious way of life – became transferred to the Christian religion. Christianity associated the idea of perfection in human life with the belief in God. Thinkers of the Patristic epoch even called the Christian faith their philosophy, implying that Christianity had replaced philosophy primarily as a way of life to be considered worthy. Axiological functions of philosophy became the domain of religion and theology. Philosophy itself became curtailed to a mere technique of thought. Theology and philosophy existed in symbiosis. To make a rough generalisation, one might say that theology represented the axiological aspect of mediaeval thought, whereas philosophy played the part of its theoretical aspect. Thus, the only viable philosophy was religious philosophy.

The emancipation of philosophy and its independence from theology would only occur in the modern age, when philosophy allied itself with the nascent experimental science. This alliance was perfectly natural, according to the logic of cognition. However, an important fact is often disregarded – it concerns the axiological aspects rather than theoretical. In order to function autonomously, science became emancipated from the contemplative view of the world and proclaimed itself as a practical force capable of changing the world in such a way that people might find a tangible representation of their will for a perfect and happy life. Axiological perspectives associated with the possibilities offered by science have defined the dominant role that science began to play in society, similar to that of religion during the previous (mediaeval) period. Science de facto hijacked religion's function of a morally elevating power, suggesting the opposite method for achieving it. Belief in God has been replaced by an active attitude towards the world and the promise of heaven above has been replaced by the promise of heaven on earth. Having allied itself with science, philosophy assumed a subservient position once again – one very similar to its former theological servitude. It used to be religious, but then it started longing to become scientific when one epoch replaced another. Philosophy formulated three fundamental ideas at least that would herald the modern age as the age of science: a) the idea of necessity and the concept of nature's self-sufficiency, the implication of which being that every problem can be solved within the framework of nature without the need

for imaginary spheres; b) the idea of scientific approach as the universal approach to knowledge accessible to all people as rational beings; c) the idea of scientific, technological and social progress, capable of realising humankind's infinite potential and satisfying its various needs. Philosophy has sanctioned the dominant position of science in society and bears responsibility for society's unswerving faith in science as well as the near-messianic self-perception of the scientists. It has shaped the image of science as a morally transformative power. Francis Bacon is one of the most illustrative figures that we can refer to in order to understand how philosophy started to perceive itself and its role in culture. The *Novum Organum* by Francis Bacon contains a substantiation of the method of scientific empiricism; another work entitled *New Atlantis* describes the happy existence of humans in a world that has been transformed by science.

To conclude our brief overview of the history of philosophy's attempts to fuse epistemology with axiology and the subsequent changes of the role it played in society, let us point out that presently it is faced by the necessity to take decisions of a qualitatively new nature. The situation can be described in a few words as follows: philosophy's assumption that science as a force capable of altering the world would also act in the capacity of a morally elevating power has been wrong for the most part. Science and related material transformations in human society have not only exceeded the expectations of the past, but even the fantasies. However, no expected moral changes have ever taken place. External successes such as incredible growth of the level of human comfort did not bring about any inner growth in human beings. Today it has become perfectly clear that the way to moral perfection does not lie through the domains of science and the material progress that it engenders. We are not discussing the potential of science and technology here – it is vast and virtually limitless. But even if we assume science capable of attaining exhaustive knowledge of the world, answering every imaginable question and provide for as great an abundance of material goods as one may only imagine, will it do anything to solve the mystery of human existence or solve our moral problems? The synthesis of rationality and morality, or the axiological and epistemological attitude towards the world that was embodied in the ideals of scientific philosophy, is no longer regarded satisfactory today. Philosophy needs to rely on a

wholly different methodology for solving its primordial problem – finding a rationally substantiated way towards dignified and perfect human existence is the problem that it needs to solve right now, and the way it solves it will define philosophy’s position in society.

It appears that philosophy has got no viable solution to this problem so far. However, what it has got is the awareness of the necessity of search – the awareness of being dissatisfied by the classical ideals of scientific philosophy. As I was preparing my paper, I have sorted through many answers given by the thinkers of the modern age to the question of the nature of philosophy, only to discover that they define it in a variety of ways, but never as a type of cognition. It is possible that this awareness of dissatisfaction will lead to a new synthesis. It would be edifying to quote the words said by Henri Bergson a little more than a century ago at the Fourth International Congress of Philosophy in Bologna: “What a strange force this intuitive power of negation is! How is it that the historians of philosophy have not been more greatly struck by it? Is it not obvious that the first step the philosopher takes, when his thought is still faltering and there is nothing definite in his doctrine, is to reject certain things definitively? Later he will be able to make changes in what he affirms; he will vary only slightly what he denies.” It is possible that this very negation, this pronounced critical attitude to the status quo of the world may help philosophy per se reveal itself as life philosophy today. The dominating spirit of bourgeois prosperity has to be denied – together with the very idea that existential problems can be solved by means of external comfort and unlimited consumerism.

Philosophy as the **longing for perfection evolves in that the very longing for perfection becomes the subject of philosophical analysis and transforms into ethics.** In ethics philosophy finds the awareness of itself as a way of life – as a practice of rational existence. Philosophical and ethical approach to practice is defined by the fact that human behaviour is considered in its ideal perspective – the way it may and should become within the ideally constructed world. Philosophy is primarily interested in the moral aspect of human behaviour. Obviously, morality existed before ethics and people tried to be virtuous and do their duty a long time before the first study of virtue and duty was undertaken by the philosophers. Nevertheless, philosophy



was the discipline that registered and delineated the ideal vector of human behaviour, demonstrating that it does not merely strive to be virtuous, but to be virtuous in the complete, absolute meaning of the word. Similarly to how philosophy tries to take its understanding of the world to the very extreme, ethics brings human aspirations for a virtuous life to perfection. It isn't just interested in benefits pursued by human behaviour – it aspires for the supreme good, and it is interested not only in the diversity of people's responsibilities, but their unconditioned responsibilities first and foremost. We can point out at least two distinctive characteristics of philosophical ethics as such: it perceives morality a) in a super-ethical perspective, and b) as expression of an individual's subjectness towards the world.

The first crucial characteristic of philosophical ethics is that morality is regarded from a super-ethical point of view, which provides a perspective where the conflict between good and evil has been resolved by the overwhelming victory of good over evil, and where the pursuit of perfection can result in the attainment of the perfect state. It is manifested in the two-level structure of philosophical ethics which may exist in different variants and be more or less extensive.

In antiquity, the idea of two kinds of ethics, or, rather, ethics and super-ethics, has been formulated and conceptually substantiated the most extensively by Aristotle and the Stoics. Aristotle distinguishes between two eudaimoniae – the secondary, or lower eudaimonia, which represents the happiness of an active existence and associates with ethical virtues, and the primary, or higher eudaimonia, which corresponds to philosophical contemplation and is realised in dianoethic virtues. Aristotle emphasises that the state of the first eudaimonia is only reached by human beings very rarely, and not because of their being human, but rather due to having “something divine” inside. This distinction between the two levels becomes the keystone of the ethical theory developed by the Stoics, who drew a sharp distinction between relative values determined by human nature and outer circumstances of human life and manifested in preferred and rejected actions, and absolute values associated with the logos and embodied in the opposition of virtue and vice. This second level of actual virtue can only be reached by a very limited number of wise people – stoics believed that less than a handful of those could be named.

The two-level structure of philosophical ethics merged with the religious idea of two worlds during the Middle Ages, according to which the moral perfection of a human being and their struggle against their own sinful nature during their earthly life are to be considered from the super-moral perspective of existing in paradise. When Jesus was addressed as “good master,” he replied as follows: “Why callest thou me good? There is none good but one, that is, God” (Mark 10:18). Isn’t that similar to Plato’s idea and words that “wise is a great name which belongs to God alone?” (Phaedrus, 278d). The concept of a super-ethical level of moral behavior was of great importance for religiously oriented ethics. It was so important that without the context that it provides one can never understand the discussions about theodicy and the proportional relation between God’s grace and free will, which were so typical for ethicists during that epoch.

Modern age ethics was oriented towards the scientific ideal – the idea of a super-moral extension of moral aspiration is still there, albeit formulated in a rudimentary manner. Spinoza orients his entire ethical system towards the super-human perspective – perceiving God in the context of eternity. According to Hegel, morality is a manifestation of the objective spirit; however, the objective spirit is not the last stage, and its limitations are transcended by the absolute spirit, which is also a pre-requisite for the objective spirit’s existence. The ethics of the absolute spirit erode the boundary between good and evil, which makes it the postmoral and super-moral crown of the edifice of Hegelian thought. Kant remains within the limits of possible experience in his formulation of the categorical imperative. However, he does not stop there. He introduces the utopia of the Kingdom of Ends and the postulates of practical reason. The Kingdom of Ends represents a super-ethical perspective, and the postulates of practical reason serve to substantiate it. In this super-ethical perspective, morality transcends the limitations of duty and merges with a transformed existence.

A qualitative shift in the philosophical perception of morality occurred after Kant and Hegel. Philosophy started to doubt morality itself. Ethics has undergone the transformation from a discipline concerned with morality, its theory, into critique and rejection of morality. Its purpose was no longer defined as understanding the logic of a moral mind, bringing it to its logical conclusion and finding a more perfect wording for it, but

rather the discrediting of morality and the exposure of its inherent hypocrisy and illusionary nature. Philosophy broke away from morality. The most consistent and open espousal of the new view of morality can be found in the words of Karl Marx and Friedrich Nietzsche. According to Marx, morality is the tool used for enslaving the proletariat spiritually. He claims that future Communist society will have no place for morality or any of the other forms of social consciousness alienated from individuals. To Nietzsche, morality is the greatest lie and the essence of Tartuffery; he sees it as the manifestation of the slavish mind, Ressentiment of the weak and their impotent malice. Nietzsche described the perspective of the *Übermensch* – one who is beyond good and evil – to counter the morality of Socrates, Kant, the Christians and the Socialists. It has to be emphasised that Marx and Nietzsche share the main interest, which is transcending morality as opposed to becoming moral. They destroy the entire domain of morality and ethics. To them, the transition to the super-moral level no longer represents the extension or conclusion of the logic of morality – on the contrary, it is viewed as the result of abandoning it.

After Marx and Nietzsche, nobody appears to have expressed views as radical as theirs; nevertheless, they have recorded the crisis of philosophical ethics and greatly influenced its further development in that philosophical ethics would subsequently lose its trust for morality after having trusted it for millennia. It chose the path of antinormativism. This also applies to the subdivisions inside ethics that develop according to the tradition of school philosophy and remain true to the classical view of morality. All the differences between the Utilitarian, Kantian, meta-ethical, naturalistic and other theoretical approaches to morality notwithstanding, what they all have in common is contenting themselves with regarding morality as an object of cognition in the very shape that it assumes in reality. Basically, none of them allow for it to be regarded from without, or to have an extension and a conclusion in another perspective. In general, they do not allow for the existence of the secondary, or the super-moral level, which correlates perfectly well with the state of axiological confusion characteristic for philosophy in general as pointed out above.

The second characteristic of philosophical ethics is that it perceives morality as a manifestation of an individual's subjectness. Philosophical contemplation of morality is focused within the question "What ought I to do?" This question elevates the individual to the level of the subject –

one prepared and capable to act as though their activities and decisions were the only decisive factor shaping the world affected by their actions. Ethics has interested philosophy as a practice of its own – as a way of implementing its concept of perfect life (one organised rationally). First and foremost, it has been concerned with studying the possibility and the direction of this process. The issue was to find a philosophically substantiated programme of individually responsible behaviour on the basis of the will for choosing the best option for themselves, which is inherent in every individual and universal in this sense.

Similarly to how ethics was the focal point of philosophy, the focal point of philosophical ethics itself was the production of a normative programme of honourable behaviour and perfect lifestyle. Thus, the ethical ideals and practices of contemplative bliss, eudaimonism, Stoicism, Epicureanism, love, heroic enthusiasm, duty, rational selfishness etc. have been formed and penetrated the European culture within the borders of philosophy and largely because of it.

However, modern ethics has undergone a substantial shift even in this respect – namely, it can be described as a de facto rejection of the duty to point out the way for an ethically justified existence. Philosophical schools no longer develop any ethical normative programmes – either deliberately or as a matter of circumstance. Should a young person decide to use the works of Epicurus, Spinoza or Kant as existential beacons, they would find any number of recommendations for action in their philosophical works. But if they decide to turn to the philosophy of Wittgenstein, Husserl or Heidegger with the same purpose, they are in for a great disappointment. The systems offered by those philosophers contain no dedicated ethical part – they do not pose the question “What ought I to do?” And something one will definitely fail to find in their works is anything remotely resembling a generalising formula of morally sound behaviour similar to the categorical imperative. Even when these philosophers consider the actual problematics of ethics (in meta-ethics, for example), they usually fail to go any further than describing the norms and performing logical analysis of the same, researching the issue of criteria used in differentiating wrong from right and studiously avoiding saying anything about the nature of right and wrong. If previously philosophers would study ethics to ascend to the level of a moralist, this transformation is what they dread the most today.

Both philosophical critiques of morality and the rejection of the necessity to formulate universally relevant ethical and normative programmes from the part of philosophy relativate the very concept of a moral norm. There is no means of transitioning from the norm to the act. One must distinguish between an act in a variety of definitions and the fact of having acted. Moral responsibility for an action is associated with the *fact* of having acted. Mikhail Bakhtin, who is to be credited with the decisive role in substantiating the moral sovereignty of an action, is perfectly precise and aphoristic in his expression of this idea: “It is not the content of an obligation that obligates me, but my signature below it.” The search for the space of an individually responsible behaviour has been going on as long as ethics has been in existence. Now it has come to the conclusion that the space in question can be defined as the actual decision about the act that becomes the cause of it, and, consequently, that all the actions committed by a person pertain to this space. The basis of moral responsibility is not the logical procedure of adapting a private case to a general rule, but the kind of wisdom that manifests as the ability to make judgements in private cases and differentiate between the right, or the honourable, from the wrong, or the dishonourable.

The ability to make moral judgements and the morally responsible actions wherein it is realised do not stem from the individual as the subject of action – they establish the individual as a subject – a person. In this interpretation, philosophical ethics rejects the concept of a universal and obliging answer to the question “What ought I to do?” – it delegates the answer to every individual that acts. In this sense, each ethically mature individual is their own philosopher – insofar as they are morally responsible for their actions and the normative programme objectively defined by such actions. However, in order to be worthy of one’s ethical vocation, one must develop a philosophically critical *Weltanschauung*, which implies and demands that the world receive the sanction of reason – not just general, scientific, absolute etc, but rather the kind of reason that coincides with the reasoning of the acting individual where it matters, when a responsible decision is made. The individual who makes the judgement (or acts) and the individual who thinks have the following in common: in both cases (and, possibly, only in these two cases) the individual acts as an autonomous entity – one relies on oneself, one’s will and one’s reason.

Translated by *Mikhail Yagupov*

## I. EPISTEMOLOGY AND LOGIC

*V. Lektorskiy*

### RATIONALITY IN CONTEMPORARY CULTURE

Nowadays there are two opposite challenges to rationality as a cultural value. Both of these challenges have a lot of followers.

The first one is the idea according to which rationality as a means of understanding the world and of projecting practical actions has failed. The followers of this approach to rationality formulate the thesis that contemporary social world consists of non-stable, rapidly changing processes, that it is the world of chaos, risks and unpredictable dangers, the world of individuals with fragmented identities, the world in which the border of the normal and the non-normal is disappearing. Followers of such idea believe that in such a world human beings achieve genuine freedom which is bound by rational prescriptions.

According to this view rationality should be understood as bounded at the best case, that it can't be considered as high cultural value, that the ideal of rationalizing inter-human relations and the understanding of rationally as a means of achieving freedom should be thrown out. Now in some circles the mention of rationality is considered as something archaic. Such ideas about rationality are popular in the contemporary culture: not only in philosophy, but also in human sciences, in the theory of education. For example, some people believe that the first aim of school is not teaching critical thinking, but cultivating artistic qualities, not abilities to argue, but emotions and imagination. According to this position the authority of a teacher should be diminished, as the teacher embodies repressive cultural norms, in particular repressive norms of rational reasoning.

But there is also another approach to rationality, which is opposed to the first. Nowadays an idea is becoming more and more popular: the idea of appearance of the “knowledge civilization”, in which producing, spreading and using knowledge determines technological, economic, social and cultural processes. In this civilization scientific knowledge plays a very important role. Knowledge presupposes rational justification. A new phenomenon is arising: the phenomenon of so called “techno- science”, in which fundamental knowledge about the nature, the society and the human being is closely connected with technological prescriptions for transforming real processes. Such products of contemporary techno science, as nano-, bio-, information and cognitive technologies begin to be used for radical changing the surrounding world and the human being himself/ herself.

Rationality not only continues to play an important cultural role. It tends to become a dominant factor of human life and moreover to transform the human being himself/ herself. Scientific-technocratic utopias of creating the post-human being are becoming more and more popular. These are not only fantastic, as they stimulate elaboration of the programs of scientific researches and technological developments.

It is the second contemporary challenge to rationality. Such understanding of rationality not only considers it as an important condition of human life, but as “super-rationality”, which supplants other values and which can radically change the human being, to create instead of him/ her a being of another kind.

These two approaches seem to be opposite to each other. The first of them casts doubts on principal importance of rationality in human life. The second one defends the idea of super-rationality, supplanting or abolishing all other human values. But the both challenges have something common: they separate rationality and freedom. The first suggests limiting rationality for extending the space of freedom. The second suggests limiting freedom for the sake of rationality.

In order to better estimate both challenges and to show their principal drawbacks I will formulate two possible notions of rationality.

There are two possible notions of rationality.

According to the first rationality is activity in the framework of accepted cognitive and value presuppositions. It is regulated by definite norms and rules, which are accepted and are not revised. From this point of view cognitive rational activity includes formulating factual assertions, suggesting hypotheses, projecting and carrying out experiments. It includes also constructing and elaborating theories, solution problems, which arise in the framework of a certain theory. Practical rational activity is considered as including taking into account personal or collective preferences, choice between them on a base of definite standards, formulating goals and the most effective means (plans, projects) of their realization. Such understanding of rationality is wide spread.

But it has an essential drawback. According to this understanding the presuppositions of rational activity – cognitive and value ones – are accepted as given and non-revisable. The efficacy of such understanding and practice of rationality is limited. In a broader context it can be destructive. The incapability to go out the framework of a certain theory can block intellectual progress and can transform a rational elaboration of a theory into a kind of scholasticism. The rational realization of a certain goal on a base of some preferences can come into collision with actions of other people, based on other preferences and as result an action can be completely ineffective.

Such understanding of rationality can be more dangerous. It can happen in such cases, when a certain idea or a theory is considered as out of any possible doubts and in addition is interpreted as the foundation for the practical transformation of the world. Contemporary ideas of modification of the human being and creation of “the post-human one” are of such a kind. But similar attempts existed in the past. I will give two examples.

The first is the conception of the rational society and the rational person which was suggested in the 70-ties of the last century by the outstanding psychologist B. Skinner. He elaborated a theory of programming education. Skinner believed that the ideal society must program the human behavior, making it rational. From his point of view a rational behavior is expedient in relation to the social whole. In the rational society free choice and moral qualities are not necessary, as this society exists “beyond freedom and dignity”.



Fortunately, nobody intended to realize Skinner's ideas. But some people tried to realize another project of a rational society. The consequences of this were disastrous. I mean Marx's ideas about rationalization of social relations.

Marx was a humanist. His conception of humanism was a continuation of humanist ideas of the European culture: a human being is free, if he/she can control natural and social environment and use external processes in his/her own interests. But it presupposes rational comprehension these processes and possibility to predict their results. According to Marx humanization of the society and the human being means rationalization of inter-human relations, which must be "transparent". This rationalization is possible on the base of planning social relations in the interests of the whole society. Each individual acts rationally to a degree in which he/she coordinates his/her goals with the rationally understood social good. Marx himself was against all forms of authoritarianism and bureaucracy. But in practice his ideas about rational regulation of social relations have produced a totalitarian system: rational calculation of social processes from above is possible if there is a huge bureaucratic system which ruthlessly suppresses all that deviates from such rationality.

Certainly, understanding of rationality as activity in the framework of non-dubitable and non-criticizable presuppositions not necessarily leads to such dramatic consequences. But in any case it is defective, if there is no addition to it as the second notion of rationality.

That is the understanding of rationality as reflective account, rethinking and revision of cognitive and value presuppositions. It is possible if one can go out these presuppositions. It can be made in the process of critical dialogue with representatives of other cognitive and value attitudes. In the case of cognition it is a discussion between different theories, research programs. In the case of practical actions it is communication and critical discussion of preferences of different individuals, social groups, cultures. As a result existing presuppositions are developed and revised: not only interpretations of the world and cognitive methods, but also individual and collective preferences, some value attitudes. Nowadays under the situation of globalization and intensive interaction of different cultures the role of critical reflection and rational dialogue is of exceptional importance.

But a critical dialogue presupposes a definite condition of its possibility. It is freedom and equal rights of its participants. A discussion can be rational only if participants can consciously and freely suggest arguments and criticize other positions. Rationality as reflective and critical activity is possible only in a definite value system, including freedom and mutual recognition. Rationality can't be reduced to freedom, and the second to the first. Both of them mutually depends on each other. In general rationality as one of important cultural value presupposes moral obligations, compassion, love etc. – those qualities which are specific for a human being.

Philosophy, beginning from the time of antiquity, played the role of critical rational reflection in relation to existing culture and was an important factor in the process of revising many ideas, rejecting prejudices and giving an impulse to cultural development. To-day its role is becoming more important. Earlier philosophy addressed to a narrow circle of intellectuals. Now under condition of arising “knowledge civilization” and intensive interaction of different cultures reflective and critical rational thinking is becoming a necessary part of everyday life.

It is especially clear in the system of education. A lot of theoreticians and practitioners in this field (in particular, in the USA, Russia and other countries) think that it is necessary to teach creative and critical rational thinking in school, and that the best way of doing it is teaching philosophy in a special form for many years. Because according to this idea philosophy in more degree, than any scientific discipline, liberates thinking and affords to doubt statements that are usually considered evident. It is important that pupils should not study philosophical texts and discuss already existing philosophical conceptions, but should be involved in philosophical thinking, should try to give their own answers to some problems that can arise in ordinary life, but which have philosophical nature. Pupils with the help of special texts and a teacher are involved in the discussion of problems that have no generally accepted solutions. A discussion, something like a Socratic dialogue, arises between pupils. The participants of a dialogue put questions to each other, answer to them, formulate arguments against given answers, give counter-arguments, put new questions etc. The participants of such a dialogue acquire not only ability to reason, to argue, but also to view analogies, to take into consideration a context, formulate hypotheses,

give non-trivial solutions. They are taught ability to ask such questions that presuppose non-trivial answers. Questions of participants to each other help to find such presuppositions in their reasoning which were not clear to them before a dialogue. A teacher is not a representative of repressing rational norms, as some contemporary opponents of rationality assert. The teacher organizes a dialogue. He asks such questions that don't suppose a single and known answer, but stimulate a discussion and direct it.

Rationality always was and continues to be an important cultural value, constituting the human being. Freedom, mutual recognition, moral values are impossible without rationality, and the latter one without them. Nowadays rationality is facing new challenges. There are dangers, on the one hand, of giving it up as a high cultural value, and on the other hand, its understanding as suppressing other values and the human being himself/herself. Meanwhile the human being has not the future without rational reflection and critical discussion of cognitive representations, value attitudes and practical preferences.

**ROMAN JAKOBSON'S LIFE IN LANGUAGE AND THE  
EPISTEMOLOGICAL POTENTIAL OF HIS IDEA  
OF STRUCTURE**

Jakobson's ideas are so intertwined with the context of modern intellectual life that we often find it hard to identify Roman Jakobson's contribution in what we consider common knowledge; his contribution has become our own<sup>1</sup>. Jakobson's work is an example of how a study of structure – of language and other humanitarian objects – was created, distributed, and rejected in certain ideological and political contexts, but nevertheless remained an epistemological landmark in humanitarian knowledge as a whole. Since much of Jakobson's legacy remains to be explored, we are facing a question: what is gone, what remains, what has crossed over from the twentieth century into the new millennium?

The main point of the paper is that the idea of structure in general and Jakobson's idea of structure in particular do not refer solely to the history of cognition. Acting as a kind of counterpart to the philosophic idea of objectivity, in our days it gains new relevance. But structure in question is not dogmatic or static. Jakobson's approach to structure and his way of building structural linguistics never alienates structure from history, from dynamics, which also penetrates synchronic approach to language. At that, Jakobson never diverges from the aspect of meaning, function, goal – not even in the process of formalizing the phonologic and other levels of language. He actually deals with

---

<sup>1</sup> Toporov, V. N. *Introduction*, in: *Roman Jakobson: Texts, Documents, Studies* / Ed. Baran, H., Gindin, S. Moscow, RGGU, 1999, p. XXI [in Russian].

what could be called “open structure”<sup>2</sup>. This multi-dimensional concept allows us to grab many important implications: not only the hidden order in the organization of things, but also the dynamics of an object and its cognition, openness to context, interaction of different disciplines studying structure, and much more.

In this case I have chosen to analyze the aspects of Jakobson’s work that are less-studied but very important both for understanding his personal evolution and for apprehending the mechanisms of humanitarian cognition in various ideologically loaded contexts. This mostly refers to the early stage of structuralism: to the moment a structure is born and its idea is developing. This material is very interesting for the philosophy of science as an epistemological discipline. Metamorphoses of structure in the history of culture and cognition – these are the contextual transformations of an idea as applied to particular people and contexts. In general, we could say that Jakobson was a link in idea of structure’s travel around the globe, with landmarks being Moscow – Prague – Copenhagen – Harvard – Moscow.

In his early works (1920–1930) Jakobson defends ideas of the emerging structuralism in the form of propaganda of achievements of the “Russian science”<sup>3</sup>, with its original teleologism and antireductionism; in “Russian science” Jakobson saw a form of thought most appropriate to perception of structuralist ideas. According to Jakobson, practical representation of such “Russian science” created outside Russia was a concept of «Eurasian» linguistics. With this concept Jakobson specified on the linguistic level the ideas that N. S. Trubetskoy and his closest colleagues conceptualized in the form of publicistic, philosophical and ideological articles<sup>4</sup>. At that, being a founder of the international *Slavisches Rundschau* journal (publishing house Berlin/Prague), Jakobson mobilized the international community to create new science and at the same time

---

<sup>2</sup> Avtonomova, N. S. *Open Structure: Jakobson–Bakhtin–Lotman–Gasparov*. Moscow: ROSSPEN, 2009, 504 p. [in Russian].

<sup>3</sup> Avtonomova, N. Roman Jakobson: deux programmes de fondation de la slavistique, in: Gadet, F. et Sériot, P. eds. *Jakobson entre l’Est et l’Ouest, 1915–1939. Un épisode de l’histoire de la culture européenne* (Cahiers de l’Institut de linguistique et des sciences du langage – ILSL, No. 9, 1997. Pp. 5–18; Avtonomova, N. S., Gasparov, M. L. Jakobson, Slavistics and Eurasionism: Two Conjunctions, 1929–1953, in: *Roman Jakobson: Texts, Documents, Studies*. Pp. 334–340.

<sup>4</sup> Sériot, P. *Structure et totalité*. Paris: P.U.F., 1999.

to overcome scientific and human lack of integration. In particular, he disregarded political and ideological obstacles and tried to attract to collaboration of all his like-minded Russian colleagues: both emigrants from and residents of the Soviet Union<sup>5</sup>. The early works of Jakobson have a few ideologically tight places, but the essence of his program goes beyond them. In any case, both the program of “Russian science” and the “Eurasian episode” as stages of development of structuralist thought make us reject traditional linear historical and linguistic descriptions. They also emphasize how the idea of structure persistently appears and develops in very different social contexts.

What is the epistemological outcome of this dynamics of search? It seems like we could agree with P. Sériot, who thinks that “structure” in Jakobson’s early works was not a solid, well-shaped concept. It was rather a certain set of variations of meanings around synthesis, wholeness, a system with an unclear proportion of parts and wholes, and with undefined limits. But I take a different stance on the interpretation of the wholeness problem in Jakobson’s works than do the Western researchers who treat it suspiciously, like a metaphysical remnant. I think the point here is not in the obsessive search for symmetries<sup>6</sup>, but rather in the intuition of the world’s unity, which does not replace structure as a scientific concept, because it exists on an entirely different level. Jakobson’s intuition of the whole (of the world and its cognition in different spheres) allowed him to attract to the common cause both his own experience and the experience of other people; it accounted for overtaking the existent level of knowledge and made possible breakthroughs to a new vision. Therefore, the whole here is not a romantic prejudice or an inaccuracy of incapable language, but a constantly present sign of intuition which organizes work.

Jakobson was passionate about his work and saw an existential meaning in everything he did: “he had a deep personal interest for scientific problems – both large, critically important, and small – we could say, he

---

<sup>5</sup> Avtonomova, N. S. Slavische Rundschau journal: a form of self-assertion of the «Russian theory»? in: *Russian Theory: 1920–1930s. In the materials of Lotman Readings*, No. 10, Moscow: RGGU, 2004. Pp. 81–102 [in Russian].

<sup>6</sup> Milner, J.-C. A Roman Jakobson, ou le bonheur par la symétrie, in: Milner, J.-C. *Le périphe structural. Figures et paradigmes*. Paris : Le Seuil, 2002. Pp. 131–140.

saw an existential meaning in them”<sup>7</sup>. He had an amazing ability to draw energy from any circumstances, even negative. Days before the Nazis attacked Europe, he was heard to say that he had “never worked so hard before”. Jakobson was not an economic emigrant, he brought together the world scientific community in the interest of the new discipline that he protected and promoted. He organized linguistic conferences; people in the circle that gathered around him, the “Prague Russians”, all read each other’s works and held heated scientific disputes. So the early emphasis on the “Russian science” which later faded away, never contradicted Jakobson’s cosmopolitanism, his capability for practical dialogue with scientists of different fields and views, from Niels Bohr to François Jacob. Jakobson actually saw his task as a scientist in building bridges between cultures and people, regardless of social and political differences.

Jakobson saw himself, as we know, as a “Russian philologist” and this is what, at his request, has been engraved on his tombstone. A philologist is someone who loves language as is, in all of its manifestations; Jakobson described his whole life as a “life in language”<sup>8</sup>. Through his structurally oriented philology he was moving towards an enormous cultural material. At the same time, he took into account those points related to dynamics and sense of scientific cognition that were ignored by narrower-focused scientists. This allowed him, using linguistic structuralism as a methodological axis, to build bridges between poetic futurism and structural phonology, between communication theory, thermodynamics, and genetics. His approach to structure, which did not exclude but rather assumed wholeness, allowed him to intensify connections between different humanities disciplines, to draft a connection between humanities, mathematics and sciences, as well as between wider spheres of culture: science and arts. This integrative factor in modern culture is just as important as analytical and differentiating approaches: it gives them meaning and lights their way.

---

<sup>7</sup> Glovinsky, M. *Roman Jakobson in Poland*, in: *Roman Jakobson: Texts, Documents, Studies*, p. 260.

<sup>8</sup> Jakobson, R. *Une vie dans un langage. Autoportrait d'un savant*. Paris: Editions de Minuit, 1985.

## HUMAN EMBODIMENT AS A COMPLEX PHENOMENON

This paper is dedicated to a problem of the human embodiment as a complex phenomenon analysis<sup>1</sup>.

A lot of approaches in a modern philosophy result from the attempts to answer a traditional question, what is the primarily one: a matter or a consciousness, a mind or a body, a flesh or a spirit? What is derivable and what is the initial one? Are these beginnings reducible to one another or they are not? Or may be both of them coexist as two independent fundamental principles of a realm?<sup>2</sup>

---

<sup>1</sup> Investigation is supported by the grant of Russian Humanitarian Scientific Foundation and Byelorussian Foundation of Fundamental Investigations. Grant No. 11-23-01005 a/Bel “Innovative Complexity: methodological, cognitive and social aspects”.

<sup>2</sup> Neisser, U. The Roots of Self-Knowledge: Perceiving Self, It, and Thou, in: *The self across psychology. Self-recognition, self-awareness, and the self concept* (Annals of the New York Academy of Sciences, New York, 1997), Pp. 15–29; Sperry, R. W. In defense of mentalism and emergent interaction, in: *Journal of Mind and Behavior*. 1991, No. 12: 221–246; Smillie, D. Sociobiology and Human Culture, in: *Sociobiology and Epistemology* (Dordrecht 1985), Pp. 75–97; Edelman, G. Consciousness: The Remembered Present, in: Pedro, C. Marijuan (ed.) *Cajal and Consciousness. Scientific Approaches to Consciousness on the Centennial of Ramon y Cajal's Textura* (Annals of the New York Academy of Sciences. Vol. 929, New York, 2001), Pp. 111–123; Beskova, I. *Evolution and Consciousness: New Outlook*. Moscow, 2002, 255 p. [in Russian]; Merkoulov, I., in: Beskova, I., Gerasimova, I., Merkoulov, I. *The Phenomenon of Consciousness*. Moscow, 2010, Pp. 25–131 [in Russian].



To see the character of interrelations between these origins in a true light, it is useful to involve the ideas developed in a vein of a modern synergetic paradigm as a theory of complex nonlinear systems<sup>3</sup>. To start such consideration, I'll tell some words about the structural organization of a human embodiment according to which the property of complexity – as a fundamental quality of open, no equilibrium systems – will be examined.

Within the limits of the human embodiment structural organization I allocate three levels<sup>4</sup>. First of them is a level of organism's separate subsystems from a view point of their functioning as a relatively autonomous ones. The second one is a level of their combination in a simple conglomerate (the given way of suggestion does not assume the manifestation of a type or a character of interactions in the set; it only indicates the fact that some variant of a connectivity between system's elements is taking place). And the third one is the level of an emergently arising new type of connectivity on the pointed field of interrelations: it is a unit acting in an outer space as a separate, autonomous, self-functioning wholeness, having its own needs and its own possibilities of their satisfaction and in appropriate way representing her to the world. I name first two levels the basic ones and the third – a derivative one. Each of these levels has its own requirements, opportunities, laws of functioning and principles of decision-making.

But can we presuppose that one and the same entity (human embodiment) has different characteristics depending on a mode of functioning?

The person's organism is forming during the intra-uterine development. At this time the separate systems are functioning by using the opportunities of the nervous system and the brain to cooperate with all of them, receiving the information and directing it to each of them. Till a birth of the child it is a unique level of an organism's cooperative behavior with environment, – internal and external one. However after a birth one more level of a generality is added: an organism as a separate unit whose operative modes are relatively autonomous. Thus, according to

---

<sup>3</sup> Kauffman, S. *At Home in the Universe. The Search for Laws of Self-organization and Complexity* (Viking, London 1995); Mitchell, M. *Complexity: A Guided Tour* (Oxford University Press, Oxford 2009).

<sup>4</sup> Beskova, I. The Phenomenon of Integral Embodiment, in: Beskova, I., Knyazeva H., Beskova, D. *The Nature and Images of Embodiment. Moscow*, 2011, Pp. 149–328 [in Russian]

a person's evolution it is possible to speak about a generality in three senses: 1) as about a simple set of the elements entering into given system and acting as a relatively autonomous agents, 2) as about a set of linkages permitting to coordinate the subsystems' activities, needs and modes of functioning in the frameworks of an organism, and 3) the new kind of newborn singularity that has not existed previously which acts as a coordinated, independent uniqueness, and which operates in the outer space as a wholeness. The last aspect, undoubtedly, represents the variant of *emergent quality*, i.e. the quality that appears at a level of a complex structure, but is absent at the level of its parts.

I believe that in accordance with the focus of accommodation of *Me* (a locus of person's self-identification) parameters of human embodiment functioning become differ. To do it more clear, I'll refer to a case of a dissociate disorder in a type of the multiple personality. One woman, suffering this ailment, had an allergy on roses: not only from the inhalation of their aroma, but also simply by looking at their images had she started to choke. One of the partial subpersons, periodically seized a power within the frameworks of her psyche, was the ten year boy. And so, feeling herself as a boy, she not only started to speak and behave in another way, but she also absolutely lost her allergy on roses: perceived the images of the flowers and inhaled the aroma without any troubles.

One more example is the story, mentioned in Zen texts. Once an emperor decided to visit a monastery where the prior was famous master Nan-in. Entering, the emperor saw the person chopping firewood. "Where can I find the Teacher Nan-in?" – the emperor asked him. The woodcutter was unbent, he has reflected for some time and said: "Right now you cannot find him, please, enter the room and wait there". Later the same person, whom the emperor has just met, has appeared in the room, but already in clothes of the master. The Emperor decided to specify: "Are you the person who chopped firewood?" The Teacher answered: "I am not that person, – all configurations have changed. The man who chopped the firewood was a woodcutter. His name is Nan-in also. He is very similar to the Teacher, but nevertheless, woodcutter is not the Teacher Nan-in".

In each of these examples a substratum is organically identical: the same alive essence, – in the first case – the woman who does not understand her identity, in the second, – the master advanced in self-understanding.

The first example shows, that even in a case of unconscious changes of self-identification the organism is capable “to become another” literally at a level of physiological manifestations. And the second one directly demonstrates that the realm of an alive essence is determined by mode of identification chosen by him. It means, that focus of accommodation of *Me* (a locus of self-identification) influences parameters of functioning of a substratum.

So, the human embodiment can be understood as a multileveled, spontaneous, opened system, having joint sources and effluents at each level of its organization, far from a state of equilibrium, able to demonstrate a behavior which might be characterized as a complex one. In such system the phenomena caused by many-sided, multiple, recursive character of communicational interconnections and attitudes between its elements should be shown. And one of the most valuable things here is the property of a human consciousness.

From this point of view, the mind and the body represent two different kinds of displays of a common fundamental capacity of the system to demonstrate a complex behavior, leading to emergence of new qualities and new forms of orderings. At the level of embodiment organization this capacity will be manifested in the birth of a new level of structural organization: relatively independent uniqueness, acting in the outer space as a self-dependent entity, – from the one side; and capacity of consciousness, – from the other side.

So described multileveled system of the human embodiment organization is opened, remote from balance and complex one. And it is just first two properties that lie in the basis of the emergent appearance of a new quality of the system – its capacity to demonstrate a complex behavior. The complexity of a system stipulates a positioning of new laws, new principles and new directions of a system’s development on the previously existed field of possibilities in the frameworks of its dynamics. The last ones are crystallized in arising of a new area of interconnections in the structural organization of the human embodiment – the emergence of a new, never existed wholeness: relatively independent, acting on its own basis uniqueness.

Can we say that this newborn wholeness have existed previously in any form? Yes and no. Yes, – as a kind of structural (not substantial!) precondition of the further becoming: namely those interactions and inter-

relations of structural elements, whose communicational activity later will become the basic for a system's complex behavior. No, – as any kind of “ready-to-use” present entity: neither in a rudimentary form, nor as a goal of further creation.

From this position the capacity of consciousness is the other form of that, never before existing form of connectedness. Therefore the consciousness appears to be the quality, inherent to a system and not inbred to its elements: neither in rudimentary form, nor as predetermined goal.

Thus we can say that mental capacities of a human being are the result of self-dependent, on its own base fulfilled development of a complex dynamic system, which is a human embodiment at all levels of its organization. That's why neither consciousness is reducible to corporeality, nor corporeality does automatically stipulate a consciousness. A consciousness appears to be born by a specific form of the complex systems' developmental dynamics, which are self-basing and leading to an abrupt growth of the structural organization complexity.

But more important here is the fact that the directly previous level of system's changes which are leading to a formation of fundamentally new qualities, appears to be not a formation of a new kind of organization of a system, but the emergence of a new type of the elements' connectedness in the frameworks of such system, – the connectedness, defined by the dynamics of *complex* processes. That's why though emergent appearance of consciousness seems to be correlated with corporal evolution, nevertheless it is a result of evolution of a *structural* organization of the human embodiment, namely, its *complexity*.

Now it is clear, why a traditional philosophy fails to solve a problem, what is the initial and what is the derived – a matter or a consciousness, a body or a mind. We can say: neither first, nor second, because these beginnings are connected not by a causal relationship and not by a relation of mutual conditioning. These two fundamental beginnings are connected by a relation of co-succession: both of them appear to be the consequences of more fundamental quality of opened, no equilibrium system dynamics, derived from a new quality of a structural ordering – *the complexity* of a human embodiment.

## AWARENESS OF THE BODY AS A FORM OF SELF-CONSCIOUSNESS

Man does everything in the world through his body. Many of the tasks are directly related to the functioning of the body, such as obtaining food, the protection of life, reproduction, and satisfaction of other natural requirements. Social communication with others may have as its object such extra-corporeal objects as cultural norms, beliefs, scientific theories and other. But, nevertheless, any action must be carried out through the activity of the body: you need to write the text, to say the judgment, to enter into a conversation with someone and so on. Only in this case will be the possibility of real communication between subjects. This allows considering the body as a necessary tool that is used by the subject to perform all his actions.

The first is to identify what is the body on that understanding. Dictionaries define the body as “the whole physical structure that forms a person or animal”<sup>1</sup>. However, for the problem of our consideration this definition is too general and has little to clarify about the role of the body in the process of self-consciousness.

I understand self-consciousness as a special form of knowledge – which manifests itself in the interaction of the Subject with the reality<sup>2</sup>. It does not have to be conscious reflection every time; we can talk about tacit

---

<sup>1</sup> *The Body. Oxford Dictionaries*. Copyright 2013 Oxford University Press.

<sup>2</sup> For more details of this view: Lektorskiy, V. Belief and Knowledge in Modern Culture, in: *Knowledge and Belief in the Dialogue of Cultures*. Washington, 2009. Pp. 183–190.; Lektorskiy, V. Rationality as a Cultural Value, in: *Rationality and Its Limits*. Moscow, 2012. Pp. 185–197 [in Russian].

knowledge (Michael Polanyi wrote about it<sup>3</sup>), as well as about other forms of knowledge (like the separation of knowledge for “knowledge-what” and “knowledge-how”, conducted by Gilbert Ryle<sup>4</sup>). But in any case we are talking about the subject-object relationship – what can be considered as a general form of cognitive action. Hence, I propose to identify the body as “a set of tools of perception, which are used by the subject in the investigation of reality”. By using this definition, we are able to consider the job of quite simple forms of cognition of reality separately (vision, hearing, and so on) and to clarify their relation to the activity of self-consciousness.

Here, I want to mention, that research of the cognition, presented by the cognitive sciences, is one of the most popular trends in philosophy today. Among the more advanced theories the concepts of “Embodied Mind”<sup>5</sup> by Francisco Varela and “Extended Mind”<sup>6</sup> by Andy Clark can be presented. Both of them pay much attention to the problem of the body in the cognition. So, it can be confidently said that the interaction of body and consciousness is a matter of discussion in contemporary philosophy. Andy Clark notices as his predecessors an outstanding American psychologist James Gibson and Soviet psychology school of the middle of the last century (Lev Vygotsky<sup>7</sup> and others). But I want to consider Gibson's ideas in detail, because in my opinion he has revealed the correlation of self-consciousness and awareness of the body most clearly.

James Gibson investigated the work of visual perception and proposed a theory<sup>8</sup> that is radically different from the classical theory of perception, which was used in his time. Classical psychology had considered the process of perception as mainly passive ability of the subject, which occurs independently of its activity while respecting the necessary conditions (stimulation of sufficient strength and saturation). Gibson revealed that this concept is wrong. He demonstrated that visual percep-

---

<sup>3</sup> Polani, M. *Personal Knowledge: Towards a Post-Critical Philosophy*. University of Chicago Press, 1958.

<sup>4</sup> Ryle, G. *The Concept of Mind*. University of Chicago Press, 2002.

<sup>5</sup> Varela, F., Thomson, E., Rosh, E. *The Embodied Mind*. Cambridge, 1991.

<sup>6</sup> Clark, A. *Being There: Putting Brain, Body and World Together Again*. Cambridge, 1997.

<sup>7</sup> Vygotsky, L. *Thought and Language*, 1986.

<sup>8</sup> Gibson, J. J. *The Ecological Approach to Visual Perception*. Boston, 1979.

tion is primarily active work of the subject (the evidence and argument of this provision can be found in Gibson's book, mentioned above, in which he more fully outlined his views).

According to Gibson, it is the comprehensive lighting system that is given to the subject, from which he can allocate certain invariants of the form, apart from the variation. These invariants are the visible objects. Also, it is necessary to take into account that all observers are mobile and visible forms constantly change in accordance with the laws of perspective. Therefore, there is a problem of estimation of subjects own place in the environment. Crucial role is played here by the fact that the observer (in the case of humans) does not see the entire visible area, accessible from his point of view. Human view is limited by his own head and some parts of his face and these "bounding surfaces" are the most stable invariants, which define the body of the subject in visual perception. Only turning your head you can see what's going on behind you. This rotation will lead to a change in the whole world, visible from your point of view. While bounding surfaces presented by your body will almost be unchanged. Therefore, it can be maintained that the positioning of subject's place in space is established from the co-relation of visible objects and bounding surfaces of subject's own body. Of course, the subject must be aware that certain visible invariants or bounding surfaces belongs to his own body. This corresponds to some form of self-consciousness and can be called its simplest form.

Now, let's turn to the question: how all possible actions of the body can be committed? Action of the body can be described as its purposeful movement in space. Interesting results of researching this problem were received by Soviet physiologist Nikolay Bernstein in the middle of the last century. He described that process of the movement necessary includes a permanent correction of its execution<sup>9</sup>. Otherwise, the action would be ineffective in a constantly changing world. The CNS has to constantly monitor the flow of the action and make adjustments to meet changing conditions. When due to some reason this is not possible, then the action fails. For example, it is extremely hard to do something with frozen fingers, and even visual observation does not help

---

<sup>9</sup> Bernstein, N. A. *On dexterity and its development*. Moscow, Physical Education and Sport, 1991 [in Russian].

the situation. Lack of sensitivity of the fingers makes it impossible to effectively move them. This lack of sensitivity may be called a problem in the self-awareness of the body.

I believe that the idea of the need for constant correction of proper motions already generally accepted and does not require a detailed justification. Moreover, it is confirmed by modern attempts to create robots. Their most complex system is not a motor system, but the system of perception, which could adequately perceive the world and correct the movements of a robot. In order to successfully act, a robot must be aware of its surroundings and must be able to co-relate his own body with it. In the case of robot it's obvious, that it is the knowledge of its own state included in the implementation of each of the elementary movement – because it exist as an information in robot's operative memory. Therefore, we can speak about self-consciousness at the level of instruments of perception.

Let's go back to the theory of James Gibson. The perception is the active fulfillment of the subject as it was mentioned above. So, it must be due to subject's strivings and requirements. In developing this position, Gibson argues that the subject does not perceive the quality of the object, but a possibility to interact with it. For example, if you want to send a letter you will see this option in the mailbox, in the absence of such a need you will remain indifferent to the mailbox. However, it is worth to consider that these possibilities are inherent to the object itself and even “physical” as Gibson wrote<sup>10</sup>. The subject may perceive or not perceive possibilities of interaction with object – it depends on his needs. Yet the possibility of interaction does not depend on particular persons mind. Mailbox offers everyone the opportunity to send mail. The perception of this possibility is an active effect of the subject with the relevant requirement. Indeed, the notion of “interaction” covers the object and the subject of the action. If there is no need to send mail, the mailbox will not be noticed. However, if the mailbox is missing or broken, sending the mail will fail also. Most clearly it is demonstrated by the contact of two subjects, where the actions of one are possible only in the case of response actions of the other. For example, it is the situation of seller and buyer, predator and prey, male and female and others.

---

<sup>10</sup> Gibson, J. J. *The Ecological Approach to Visual Perception*. Boston, 1979.



We consider that, in this case, it is also appropriate to talk about self-awareness of the body. The buyer will not be able to interact with the seller and buy the product if he does not have the intention to buy. Predator hunts the victim because he has a definite need for food. Once again, knowledge is understood here not as an abstract reflection. A cat is not reflecting on the fact that it is a formidable predator, it just hunts. The buyer is not always reflecting on the advisability of purchasing. What matters is that in a case of perception of a suitable object (the seller or the victim) the subject occurs in a state in which he can perform the corresponding action (purchasing or hunting). This is his body where the requirements that guide him to act do exist. It's obvious, that another body will lead to completely another perception (Tomas Nagel wrote about it in his famous article<sup>11</sup>). Also, another body will have another requirements, which will draw attention to another possibilities of interacting with object.

Therefore, I think it is possible to speak about a specific form of knowledge, which is manifested at the level of a simple perception of an object. Since this knowledge is directly related to the body of the subject, it is worth talking about simple forms of self-consciousness.

Let's summarize this brief review. In James Gibson's theory, it is shown that an adequate perception of the world is possible only when the subject co-relates the world and his own body. This co-relation is necessary for performing purposeful movement of the body. It is impossible to define something given in the perception as part of your own body (for example, the visible part of the face or hands) if there is no object of the world, that can be co-related with it. It would be impossible to find your location in space if the other object of reality did not perceived. It is impossible to make a purposeful movement if there is no permanent control over its course – and at the heart of this control is a constant correlation of the body and the world.

Thus we can claim that some knowledge about the state of the body is a necessary part of all human activity (remember, that all actions are somehow related to a physical activity of the body). Although this “knowledge” about the state of the body often cannot be conceptualized and is a part of the “automatic” human actions (such as walking), we

---

<sup>11</sup> Nagel, T. What Is it Like to Be a Bat? in: *Philosophical Review*, 1974. Pp. 435–50.

think it is better to speak about self-consciousness of the subject. This self-consciousness appears already in such basic activities as perception, movement and control over the body. It seems obvious that such simple forms of self-consciousness are the basis for the formation of its more complex structures (e.g. Self, identity, and others). Since the activity of the body is the basis for more complex human activities, its rules should be the basis for explaining the more complex structures of consciousness<sup>12</sup>. As well as the building is based on its foundation, though not limited to it. The foundation gives basic direction for growth.

If we accept all this about the body and self-knowledge, then it appears that structure of self-consciousness is highly dependent on the awareness of the body. And awareness of the body is dependent on the structure of the body. Therefore, we can say many things about one's self-consciousness, just looking on his body. I should note here that although the reasoning of these ideas appeals to contemporary research in psychology and cognitive sciences, their essence is not novel. All the classical Greek philosophy dealt with the relation of body and mind. And their correlation and unity was doubtless. As a bright example, I want to recall treatise "Physiognomonica" (attributed to Aristotle). Although comparisons with lion and other animals may not be in the spirit of modern science, its theoretical consequences are very interesting. As noted by the Russian scholar of ancient Greek philosophy Aleksei Losev<sup>13</sup> in this treatise the union of internal and external appears most clearly.

---

<sup>12</sup> I'm not talking about the reduction of complex structures of consciousness to the simplest forms of awareness of the body – but I stand for the unity of cognitive principles to the study of consciousness at all its levels.

<sup>13</sup> Losev, A. *The History of Classical Aesthetics*, Vol. 4: Aristotle and late classic. Russia. 1963–1988 [in Russian].

## **UNDERDETERMINATION OF KNOWLEDGE BY CONTEXT: A CHALLENGE FOR SOCIAL EPISTEMOLOGY**

### **Context and its problems**

The notion of context occupies a unique place among other concepts relevant for the social epistemology. An oversimplified image of what the social epistemology is often appears as an analysis of knowledge (consciousness, language) in the social/cultural context. It has been already mentioned however that there are plenty of disciplines like sociology of culture, history of science, sociolinguistics, social psychology, social anthropology which research purposes are evidently much the same. It is therefore important to clarify the situation and to show the peculiarity of philosophical approach to context.

Recall how the classical epistemology formulated the idea of the roots of knowledge. According to it, knowledge is determined by three factors: the object, which is situated in the focus of research interest; the agent with his/her cognitive abilities; and finally, the sociocultural conditions of knowledge. As it concerns the latter, so they were considered up to the 20<sup>th</sup> century as mostly negative instance which gives rise for delusions and prejudices. Nowadays at least four main models of knowledge existence in the sociocultural context can be distinguished. Each one is influenced by a certain philosophical or scientific approach. There are: a communicative/semiotic, a cultural/anthropological, a social/institutional and a cognitive/naturalistic models. The first model (L. Wittgenstein, H.-G. Gadamer, M. Bakhtin) deals with language as a specific system representing the sociality and culture. The proponents of the second model (J. Mead, A. Schutz, C. Geertz, H. Garfinkel) un-

underline the significance of informal and nonverbal communication, of the tacit presuppositions hiding in them the mystery of sociality. In the model for which E. Evans-Pritchard, R. Merton, N. Luhmann and D. Bloor are responsible, knowledge is taken as a subsystem of society whereby the content of knowledge expresses the main parameters of the latter. And finally, the fourth model describes the sociality and culture as certain psycho-biological explanatory models. It is either the psychic inhibition causing the otherwise unexplainable deviations in the functioning of the neuron structures or a certain instrumental explanation of human behavior, or a form of determination of knowledge by the natural evolution (R. Rorty, D. Dennett, T. van Dijk, R. Dokins).

Given the differences of the models, they are united by the non-classical way of problematizing cognition. The presupposition basic for all of them consists in that epistemologist studies neither the agent nor the object nor the social conditions of knowledge but various media, or texts (natural or artificial) containing knowledge which can be extracted from them. And the classical question about the sources of knowledge is shifted to the question of intertextual relations, which symbolize and embody the interdisciplinary interaction. At least five types of texts can be separated here. Firstly, there are texts which present one's research results. Secondly, there are biographical texts internally describing the knowing agent and forms of his activity and communication with the surrounding. Thirdly, there are texts of sociologists, psychologists, anthropologists who give an external picture of the cognitive agent and his cultural community. Fourthly, there are texts containing the laboratory results of the brain studies and computer models of the cognitive processes. And finally, there are philosophical texts presenting and criticizing the cultural universals related to knowledge and its analysis. Quite naturally the concept of context originates in terms of this intertextual picture of the human knowledge as a consequence of the well-known linguistic turn. "Context" originally meant "co-text", that is a text which follows another text and builds its surroundings. In the intertextual relation, texts and contexts are distinguished due to a focus of research purpose and interest. So in order to draw the difference between text and context the typology of contexts is needed; correspondingly the most influential theories of context should be revised.

## Context theories

The notion of context became the stock-in-trade of epistemology, hermeneutics, linguistics, social anthropology, psychology, history of science, cognitive science, history of philosophy and even theology. We may, accordingly, speak of various types of contextualism correlating and interacting with each other. However, their analysis shows that the notion of context is far from being entirely clear. The invisibility of the notion of “context” becomes the focus of theoretical attention only when a distinction between the specifically scientific theories of context and the philosophic problematization of that notion is drawn. The object of context theories is constituted by various types of integrity and relations of the phenomenon studied, its inclusion into language, into the current situation of acting and communicating, into the local and universal culture. And as soon as the notion of “context” is treated by philosophy, it encounters the following questions.

Firstly, the correct understanding of a word involves taking into account its various contexts. If so, its meaning, at the most, is in fact a conglomerate of loosely interconnected sense elements. How then can we preserve the meaning’s identity, when the word in question turns out to be so vague and multivalent? How can we ensure the validity and coherence of comprehension and mutual understanding?

Besides, the genesis and functioning of a certain cultural phenomenon (in art, religion, science, etc.) is defined by a number of determinants, or contexts. However, the phenomenon in question is also characterized by its own identity, by its difference from its contexts. What then are the boundaries of reductionism in a contextual explanation? Can we reduce the expounded phenomenon to a sum of contexts – e.g., can science be reduced to the historical conditions of its formation?

Lastly, let us assume that every theory depends on the cognitive, social and cultural contexts proper to it. Are different theories, including ones widely distant historically and culturally, comparable then? Is their independent, true appraisal, their rational choice possible?

Is then context a proper explanatory tool or it requires an explanation itself?

## The limits of context

Context theories, as presented in a number of humanities, are bound to fail on account of contexts and situations being countless. Context appears then in no way a primary phenomenon objectively forming a certain empirical basis for theoretical generalizations and meaningful concepts. It is rather a secondary construction provided by the conceptual choice of a number of relevant situations. D. Bloor refers to one Wittgenstein's phrase, emphasizing these two different ways of using context:

“first, the role of context in giving meaning to our mental states, and second, the performative and self-referencing process by which the context is itself made up”<sup>1</sup>.

It means that epistemological position doesn't limit itself to believing in context as universal means. Rather, epistemology and social epistemology in particular is a critique of context. And here we can venture a reformulation of well-known Duhem-Quine thesis (Stanford, 2009)<sup>2</sup> about underdetermination of theory by data. As it refers to the problem of context, it will take the following form: “knowledge is underdetermined by its context”.

This means that no theory of context as a closed system is possible. Because of this, contemporary linguists often declare the notion of context trivial and even meaningless, since (as they reason) there is no single sentence that can be endowed with meaning outside its context. There remains only constructing models of the process of interpretation, in which context plays a major part, and deducing from that some results for the theory of language acts. The critically minded linguists who realize the limits of theorizing in their domain come exactly to this skeptical conclusion. The maintaining a balance between science and art remains, therefore, the inevitable strategy of contextual reconstruction. Its methodology is far from being algorithmic – it is rather situational.

For a meaningful epistemological use of the term “context,” we have to create its typological definition based on the various forms in which language manifests itself and on the various forms of social relations.

---

<sup>1</sup> Bloor, D. *Wittgenstein, Rules and Institutions*. Routledge, 2002, p. 49.

<sup>2</sup> Stanford, K. *Underdetermination of Scientific Theory*, in: *The Stanford Encyclopedia of Philosophy (Winter 2009 Edition)* / Ed. Edward, N. Zalta. 2009 <<http://plato.stanford.edu/archives/win2009/entries/scientific-underdetermination/>>.

This is a special task which is still far from being complete. A philosophical notion of context might be formulated not so much through summing up the linguistic, anthropological and psychological meanings of that term as by means of its contextual definition in the system of such notions as text, discourse, knowledge, culture and sociality.

While engaged in socio-cultural interpretation of a certain element of knowledge, the epistemologist is inspired by those diverse meanings with which that element becomes intertwined, being transformed from an epistemological abstraction into a cultural object. However, he forgets that any contextualization is localization, a transition from the potential diversity of senses to their actual limitedness, a transition from the general to the specific. Applied by itself, this method leads from philosophical generalization to specialized academic, interdisciplinary description – viz., to that which is to be philosophic reflection's point of departure and becomes its involuntary, albeit not final, result. The glamour of contextualism needs a philosophical context, the latter being an appeal to the absolute. Philosophy as such is a thought against the background of the absolute. Attention to context, in its turn, makes it possible for us to demonstrate that the absolute is more than just a spirit moving in "topos noetos" – it is filled with human, cultural and historical content. And still it always seeks to transcend its own contextual borders, to expand into the broader space of intercultural and intertheoretical discourse.

Thus facing contemporary naturalization programs we should not forget that it is philosophy that represents a unique method of understanding of knowledge and consciousness hardly reducible to any scientific theory. Nobody except philosophers has been interested already since ancient times in the complex, dynamic, human-dimensional phenomena, which only recently have been discovered by the sciences. Nobody except philosophers does cultivate in an explicit way a tendency towards universal synthesis, even if it appears sometimes in inadequate forms. It is only philosopher who so vividly, with fear and admiration, experiences the infinite starlit sky over the head or the moral law inside the heart, the actual limitation and potential infinity of human knowledge.

So the cases of interdisciplinarity and contextualism can be seen as the modern challengers for epistemology and philosophy in general that can lead either to its next crisis or to its new rise. To my opinion the

progress is possible through elaboration of the weaker version of social epistemology<sup>3</sup> based, first, on the non-classical view of interdisciplinarity; second, on interchange of contextualism and its philosophical problematization; and third, on epistemic values of reflexive, critical and creative thinking about the very foundations of human intelligence. This allows practicing a peculiar, controversial and boundary discourse that at the same time transcends any boundaries.

---

<sup>3</sup> Kassavine, I. *Soziale Erkenntnistheorie. Migrationsmetaphern, Wissenstypen, Textepochen*. Nichtklassische Ansätze. Georg Olms Verlag, Hildesheim, 2003.



## WHAT KIND OF REALISM DOES SOCIAL EPISTEMOLOGY ASSUME?<sup>1</sup>

### 1. Realism: A Party of Power

Philosophical realism assumes the human- and mind-independent existence of the material world. This ontological assumption is accompanied by or follows from an epistemological statement of knowledge as possessing a propositional content essentially correlated with the independently existing object. Realism goes hand by hand with the classical theory of knowledge (Descartes, Locke) historically linked with the Modern Science and the rise of capitalism.

The necessity of independent justification for science and technology manifested itself in the criticism of epistemological “idols” of the tribe, cave, marketplace and theater as Francis Bacon put it. Liberation of knowledge from “external” influence, political, religious, metaphysical, and common sense errors, was seen as a prerequisite and the purpose of the new science capable of providing an objective picture of the world.

The philosophical realism today obtains the highest social status among all epistemological trends. Its representatives wear the crown of expertise power occupying the most prestigious positions “within the mainstream of analytic philosophy departments within the English-speaking world” (as P. Boghossian puts it<sup>2</sup>). Realism is usually associated with the cult of experience, trust to common sense, political loyalty, and moral responsibility and hence locates closer to the academic establish-

---

<sup>1</sup> This work was supported by the Russian Scientific Foundation for Humanities (RGNF), grant number 06-03-00275a.

<sup>2</sup> Boghossian, P. *Fear of Knowledge*. New York, 2006, p. 7.

ment than any other philosophical discourses. Its social legitimation is due to the objectivist claims, which are easily used by any power circles for justifying its policy. Trying to save and strengthen his power, realism practices a severe critique of his opponents diminishing their theoretical significance and questioning their social reliability. This strong defense of realism as an academic mainstream provokes the following problematization of its intellectual uniqueness. Is realism necessarily limited to a version of scientific materialism or naturalism? Is realism really incommensurable with social constructivism, feminist epistemology or the like? Why is the qualification of social epistemology (SE) as “anti-realism” misguided?

## 2. The Marxist tradition in SE

There is at least one version of SE, which to a considerable extent originated from a philosophical realism of a certain kind, namely from the Marxist dialectical materialism. It is worth recalling that the latter was strongly opposed to a naïve, “metaphysical”, “mechanistic”, anti-dialectical materialism (realism) albeit recognized its positive historical role. The latter is meant to be the materialism of Descartes, Hobbs, Lamettrie, Büchner, presented nowadays by figures like M. Bunge or Churchlands.

Among the most creative and less dogmatic thinkers influenced by the Marxist tradition, we single out the following Russian scholars who had been working in the 20<sup>th</sup> century mainly outside the mainstream philosophy.

Boris Hessen (1893–1936), professionally trained as physicist, had been elected to the Russian Academy of Sciences as philosopher. He was first to give a reconstruction of the social, economic and technological roots of scientific knowledge using the case of Newton mechanics. He delivered his famous paper “*The Socio-Economic Roots of Newton’s Principia*” at the Second International Congress of the History of Science in London (1931). This work became foundational in opening the prospects for the social history of scientific knowledge<sup>3</sup>. The popular accusation of him as a vulgar Marxist economic determinist was the

---

<sup>3</sup> Hessen, B. The Social and Economic Roots of Newton’s Principia, in: Nicolai I. Bukharin, *Science at the Crossroads*, London, 1931. Pp. 151–212.

first critique on the social/epistemological approach to science. Under the Stalin's regime, he was convicted of terrorism and executed (rehabilitated 1956).

Mikhail Bakhtin (1895–1975) was professional philologist (dealt with Rabelais, Dostoyevsky etc.) though widely recognized as philosopher. He paid major attention to the concept of creative personality, to understanding of knowledge and consciousness as communicative text. According to Bakhtin, the concept of text obtains universal character and expands itself into the concept of cultural object as such. His original categories, some of which are difficult to translate (the Another, Non-alibi in Being, Dilocation, Dialogue, Polyphony) describe the life world of man within the process of scientific and literary quest. "Every human act is a potential text and can be conceived (as a human deed and not as a physical action) only in the dialogic context of the time (as a comment, as a meaningful position, as a system of motivations)"<sup>4</sup>, – he wrote. His relations with Marxism were rather ambiguous, and his standpoint is much closer to young Marx than to Marx of the *Communist Manifest*.

Leo Vygotsky (1896–1934) is one of the father-figures of Russian psychology presented knowledge and consciousness in context of activity and communication. This is a quotation from him that shows how close he was to the founders of the contextualist school (B. Malinowski, L. Wittgenstein). "A word takes in, absorbs from the entire context, with which it is interwoven, intellectual and affective contents; it begins to mean more and less than its meaning contains when considered by itself and outside its context: more, because the range of its meanings expands, acquiring a large number of new spheres filled with new contents; less, because the abstract meaning of the word becomes limited and narrowed down by that which the word signifies exclusively in this context... the sense of a word is inexhaustible... A word acquires its sense only in a sentence; the sentence itself acquires its sense only in the context of a paragraph, the paragraph, in the context of a book, and the book, in the context of the author's work in its entirety"<sup>5</sup>.

<sup>4</sup> Bakhtin, M. *Aesthetic of Verbal Creativity*. Moscow, 1979, p. 286 [in Russian].

<sup>5</sup> Vygotsky, L.S. *Izbrannye Psikhologicheskie Issledovaniya* [*Selected Studies in Psychology*], Moscow, 1956, p. 370 [in Russian].

Evald Iljenkov (1924–1979) was known as a devoted defender of the dialectical materialism against naïve and metaphysical realism (“positivism”, as he called it). He is influential within the activity approach in epistemology and philosophy of mind. His position could be dubbed today as “externalism” since he understood knowledge and consciousness as an objective ideal form existing outside the brains and presented in cultural artefacts and social relations. The orthodox Marxists treated him as Hegelian objective idealist (immaterialist). Being strongly criticized and isolated, he fell into a depression and committed suicide.

“The problem of the ideal has always been an aspect of the problem of objectivity of knowledge (“truth value”), that is relevant for those forms of knowledge that are determined and explicable not in terms of the whims of personal psychophysiology but rather due to something much more serious, something that is above an individual psyche and totally independent from it; the “ideal”, conceived as a universal form and law of existence and change of the multiple phenomena that are empirically and perceptually given to a human being is detected in its pure form and fixed only in the historical forms of spiritual culture, socially significant forms of its manifestation”<sup>6</sup>.

Mikhail Petrov (1923–1987) was well-educated in foreign languages and became then philosopher and sociologist of science. His main argument runs that knowledge and consciousness can be properly understood only as a part of historically defined “socio-code”. He describes various historical socio-codes (ancient, medieval, modern) in their peculiarity paying attention to the corresponding text types within the context of activity and communication.

“For the entire ...set of the array of knowledge and directly related institutions and mechanisms designed for various purposes, we <...> shall use the term socio-code, having in mind the main cultural reality holding in integrity and discerning a fragmented array of knowledge, the world of activity dissected into single interiors, and the supplying institutes of communication”<sup>7</sup>.

---

<sup>6</sup> Iljenkov, E. The Problem of the Ideal, in: *Voprosi filosofii* [*Problems of Philosophy*], 1956, № 6, p. 130 [in Russian].

<sup>7</sup> Petrov, M.K. *Language. Sign. Culture*. Moscow, 1991, p. 39 [in Russian].

Thus the concepts like “context”, “communication”, “culture”, “artefact” have been elaborated and used already for the non-orthodox Marxist justification of the social nature of knowledge and cognition. Now there are much more opportunities for the detailed and convincing endorsement of this standpoint.

### 3. Sociality: a positive glance

The naïve realism emphasizing the negative role of sociality in the cognitive process, identifies objectivity with mind- and human-independence. Even if the objective knowledge is no less urgent nowadays than in the New Times, there has been already broad consensus among many philosophers that the impact of sociality could be hardly exhausted with errors and delusions.

Positively conceived, sociality consists of cultural and intellectual resources, political needs and technical stimuli, which form the basic structure of the knowing agent and thus are essential for the acquisition of knowledge and its legitimation. It goes without saying that the knowing agent is taken as a person or group equipped with cultivated cognitive abilities and competences (curiosity, creativity, discourse, skills and habits, common knowledge and variety of experience, shared world picture and patterns of activity and interaction).

The rise of Modern science, which itself promoted the ideal of objectivity, can be in no sense seen as a sterile movement in a realm of pure reason. A closer look at the making of the classical mechanics reveals its dependence on a number of technological and political conditions as well as on the philosophical, religious and mystical ideas of these times (Boris Hessen, Alexandre Koyré<sup>8</sup>, Frances Yates<sup>9</sup>, Lynn Thorndike<sup>10</sup> etc.)

This empirical necessity of the social/cultural resources and circumstances for the cognitive process confirms their ontological relevance. They appear as non-mental manifestation of knowledge, which exists

---

<sup>8</sup> Koyré, A. *Newtonian Studies*, Cambridge, Mass. 1965; idem, 1957. From the *Closed World to the Infinite Universe*, Baltimore, 1965.

<sup>9</sup> Yates, F.A. *Giordano Bruno and the Hermetic Tradition*. Chicago, 1964.

<sup>10</sup> Thorndike, L. *A History of Magic and Experimental Science*. New York, 1923.

outside individual brains. Thereby social/cultural artifacts (tools and technologies, money and markets, artistic performances and religious practices, hospitals and jails, libraries and universities, behavior patterns and speech acts etc.) as a subject matter of social sciences and humanities have been rediscovered as “objective facts” sui generis. From now on these forms of sociality constitute a genuine ontology of the human mind, much more comprehensive than any neuroscience might provide. Scholars like L. Wittgenstein, B. Malinovsky, M. Foucault, W. Quine consider sociality to be objective representation of mental states (subjective epiphenomena of the human corporal activity). When H. Putnam follows the same purpose undermining internalism about reference and extension he puts it as follows: “meanings just ain’t in the head”<sup>11</sup>.

#### 4. A New Ontology for SE?

Still the discovery of the social nature of knowledge has been interpreted by the proponents of the classical epistemology as a kind of contingent “dependence” of knowledge upon social settings (P. Boghossian). It appears as if the cognitive and the social belong to the separate kinds of nature, which can be more or less arbitrarily combined. The correspondent label of relativism remains the major tool of realist epistemologists in debates with their opponents.

Social epistemologists should take this as a serious challenge. The situation requires a clarification of what relativism really is and what an alternative understanding of realism can be suggested. This ambitious task in fact requires elaborating a special ontology for SE.

The *ontological turn* in science and technology studies becomes more and more popular though the term deserves a detailed analysis<sup>12</sup>. Two basic questions are especially urgent: whether anything possesses “absolute” ontological validity; and whether anything provides “external” significance for ontological pictures.

---

<sup>11</sup> Putnam, H. The meaning of ‘meaning’, in: *Mind, Language and Reality. Philosophical Papers*, Vol. 2, Cambridge, 1975, p. 227.

<sup>12</sup> Pedersen, M.A. Common nonsense: a review of certain recent reviews of the “ontological turn”, in: *Anthropology of this century*, issue 7, London, 2013.

Social epistemologists as well as many others<sup>13</sup> can hardly release the words “absolute” and “external” from quotation marks paying main attention to a typology of situations, where the “absolute” and the “external” are both taken as *relative*. Everything, which becomes a subject matter of SE, loses its “absolute” status (either ontological or epistemological), for it doesn’t allow any study of genesis and variety. The same is with the “external”: a thorough analysis of any phenomenon reveals its cognitive relevance and dependence.

The rethinking of the “absolute” and the “external” touches upon the famously infinite discussion of *natural kinds* – a corner stone of the realist ontology. Natural kinds are supposed to exist due to their own nature, whereas the existence of secondary kinds is determined by anything else. The current issues in biological taxonomy enrich the discussion – it is about to lose the absolutist and even theological character.

And this recalls another significant opposition – of the natural and the artificial. If scientific realists trust the current scientific practice, they have to accept that the difference between “natural” and “artificial” classifications is essentially relative; moreover all classifications are artificial. And the question arises: do then natural kinds exist at all?

## 5. Heavens, cats and students

The crucial opposition of the terrestrial and celestial realms typical for the medieval theological world view ceased since Bruno and Galileo proclaimed the new astronomical picture of the world. As a result, the objectivity of the heavens lost the a priori form and has to be confirmed in regard to any astronomical or cosmological statement. How can we say, for instance, that Pluto is a planet? How can we share one’s belief that Jupiter has 15, 30 or over 30 moons? We do so referring basically to the correspondent astronomical observations and mathematical calculations confirmed by certain decisions of scientific community. Should we then persuade ourselves that “planet” is natural kind and “Jupiter has X number of moons” is an objective empirical fact regardless any circumstances?

---

<sup>13</sup> Latour, B. *Reassembling the Social: An Introduction to Actor-Network-Theory*. Oxford, 2005; Knorr-Cetina, K. *Epistemic Cultures: How the Sciences Make Knowledge*. New York, 1999.

While “scientific realists”<sup>14</sup> believe in this, the social/epistemological answer is definitely “no”. Firstly, Pluto 2006 has lost the status of a planet due to a decision of the astronomical community. Secondly, an objective fact must fix the empirical, qualitative and quantitative characteristics of an object within definite spatial/temporal coordinates, which are universally valid for all possible worlds. We cannot do with asserting that “Jupiter has 16 moons” is false though “Jupiter has over 30 moons” is true for ever. The statement “Jupiter has over 30 moons” fails to be “objective fact” for the quality and the quantity of celestial bodies are determined by the current stage of astronomy and the decision of the scientific community.

One more example of realism is presented by L. R. Baker who considers “basic ontology to be an inventory of what must be mentioned in a complete account of reality...”<sup>15</sup>. Interestingly she includes in this inventory artefacts as well. But the approach still remains tacitly oriented by the concepts like “substance” and “essence”. According to Baker, a “cat” or a “human being” are supposed to be natural kinds unlike a “student” who is secondary kind. A “cat” is taken as material thing, which is absolutely mind- and human-independent. But a closer look reveals that a “cat” is an abstract notion, it is not a material thing; not just being called a cat but the mode of existence of a “cat” means to be included in certain biological taxonomy. This is very much like performing a social role. There are no “cats” in the mind-independent nature; there are only some uncertain objects, which we call so or so and which behave themselves according to some rules prescribed to them (producing certain sounds, drinking milk, hunting mice etc.).

As Baker recognizes later as well, something is a bird or an insect in virtue of its relational properties – its genealogical lineage. She also states that social institutions and conventions are necessary conditions for the existence of many kinds of artefacts. Does this conditional and contingent type of cat’s existence differ ontologically from being a student as a social function? Or they both belong to secondary kind?

Baker assumes that artefacts have in some sense an equal ontological status with mountains. While taking artefacts as pure material (mind-independent) things due to their solid corporal structure, Baker

---

<sup>14</sup> Boghossian, P. *Fear of Knowledge*. New York, 2006. Pp. 10–13.

<sup>15</sup> Baker, L.R. The Ontological Significance of Artefacts, in: *Epistemology & Philosophy of Science*. 2011, 2, p. 55.



singles out their peculiarity: they fulfill a certain function designed for them by an intentional agent, an author. So artefacts are composed of natural elements and also depend on mental activity. This allegedly makes “nature-culture” distinction (and the deeper distinction between mind-independence and mind-dependence) irrelevant. Baker refers above all to many innovative artefacts like “robo-rats” – rats with implanted electrodes that direct the rats’ movements. But is there any difference between social functions and social roles? Baker’s answer is “yes”.

So a natural “cat” and artificial “robo-rat” are both material things and hence belong to natural kind. And being a student doesn’t depend yet on implanted electrodes that direct one’s behavior; this is a pure (that is mind-dependent, imaginary) social role that could be eliminated without any damage to a person. I wonder how French students 1968 might react to this thesis – their revolutionary uprising was exactly due to the similar belief of the French government that meant to reduce the access to this social role. And what about contemporary electronic communication – is it not a transhuman symbiosis of a person with iPhone and iPod?

So trying to justify the existence of artefacts, Baker yet disregards the floating boundary between the natural and the artificial, natural and human. As elements of the world picture, they equally exist within a conceptual framework, losing beyond it any qualitative or quantitative certainty. Hence a *philosophical ontology that provides SE is the life world of acting and communicating, experiencing and thinking agent. It is not just “being as such”*. We cannot deal with any existing objects avoiding classifications and categorizations in respect to their cognoscibility and involvement in the human world. A well-furnished room for the human being, which appears lost in the basements of the realistic ontology, can be booked only in the SE second floor.

## **6. Cognitive Realism: Back to Plato?**

The realist ontology is an obvious outcome of the realist epistemology, which defines “at least some of” its objects as mind-and human independent. P. Boghossian argues for the realist epistemology that is based

on the “standard, widely accepted Platonic definition of knowledge”<sup>16</sup>. (However in four pages he forgets this and ascribes the classical picture of knowledge to the “broad consensus among philosophers, from Aristotle to the present day”. We shall see below that history of philosophy hardly belongs to the strongest points in his professional competence.) According to the latter, a thinker S knows that p if and only if:

1. S believes that p;
2. S is justified in believing that p;
3. p is true.

Boghossian appeals evidentially (though without any reference) to Plato’s *the Teatetus*, where three main definitions of knowledge are criticized and rejected. Therefore this appeal is basically misleading – this is in no sense the Platonic definition of knowledge. Especially against the correspondence theory of truth, Plato points out that the concept of true knowledge as correlated with objective reality faces *circulus in definiendo* – the objective reality itself requires an independent definition. This critique was due to that Plato was an objective idealist who identified a genuine knowledge with eternal and immutable ideas opposed to any individual opinion, belief, perception, and the material world.

Though Plato is classified as an objective idealist, he seems to be much closer to the understanding of a proper cognitive role of culture and sociality than the realist epistemologists do. Plato was highly critical towards understanding of knowledge as a solely individual enterprise. Reducing knowledge to beliefs as mental events means to be caught by Plato’s “idols of cave” – there is no way to the universal and objective content of knowledge.

The process of justification is again reducible to mental events and their combinations due to individual cognitive abilities. Though Boghossian agrees that beliefs and justifications can differ from one person to another, from one stage of science to another one, the concept of truth seems to him a solution for all these problems. One can be wrong in believing or justifying this or that knowledge, but if the latter is true, nothing can prevent from accepting it as knowledge. But how can we

---

<sup>16</sup> Boghossian, P. *Fear of Knowledge*. New York, 2006, p. 15.

reach this desirable truth with certainty? Since “truth” is a result of comparison of belief with objective reality, it requires the concepts of reality and objectivity, which can hardly be deduced from individual mental events (“Hume’s guillotine” – mind please that it was neither Hume nor me who proposed this term!). So this evident question remains without answer as well as many others<sup>17</sup>.

But we can reconstruct an answer looking at “classical picture of knowledge” and three arguments in its favor proposed by Boghossian, which “insists on the independence of knowledge from contingent social circumstance”<sup>18</sup>.

His first thesis is called “Objectivism about facts”. Then how can we reach this desirable truth with certainty? Let us have a closer look at Boghossian’s main arguments.

## **7. Three corner stones of objectivism**

### **1. Objectivism about facts**

Many facts about the world seem to be independent of us. “Dinosaurs once roamed the Earth” is an objective fact, which is not socially constructed<sup>19</sup>.

But this statement represents rather a common sense opinion about dinosaurs than an objective fact. How does this fact really obtain objectivity? The latter appears a function of purposes, means and values of scientific community. In particular, there are: 1) a scientific definition of dinosaur (a controversy for paleontological taxonomy as we shall see below), 2) an exact period of their “once roaming the Earth” (between 237–66 million years ago – a hard problem of precise temporal location makes all our “scientific beliefs” about dinosaurs too approximate), and 3) their habitat and ecological niche (incorrectly dubbed as “everywhere” for they never existed in the water, in the air as well as in subterranean area).

<sup>17</sup> Zimmerman, A. Fear of Knowledge, by Paul Boghossian, in: *Ars Disputandi*, V. 7, 2007 <<http://www.ArsDisputandi.org>>.

<sup>18</sup> Boghossian, P. *Fear of Knowledge*. New York, 2006, p. 20.

<sup>19</sup> Boghossian, P. *Fear of Knowledge*. New York, 2006, p. 19.

So trying to justify the objectivity of a fact, social epistemologist is obliged to reconstruct the entire palette of discussions and conventions that is the underlying social interactions. Science is knowledge in flux, which evolves through contradictions, ambiguity, negotiations. And there is absolutely no sense of speaking in this context about an immutable “nature in itself” unless one would like to appear too naive.

## 2. Objectivism about justification

P. Boghossian argues that the fossil record we have discovered constitutes evidence for the existence of dinosaurs. What is the epistemological status of this statement? Is it an ordinary opinion or an empirically testifiable implication from a scientific theory? The first one is more relevant for sociological study of mass consciousness than for epistemology. So it should be a consequence of a theory.

Recall that the first fossil records were interpreted for a long time as remnants of mythical giants or of the Troy battle heroes. And there is still a huge controversy about the scientific definition of dinosaurs. It is due to the plurality of biological taxonomies representing group interests within scientific community.

So it would be more correct to say that the fossil record gives evidence (arguments?) not for the “existence” but rather for some current theories or social conventions about dinosaurs. And here we need to go into some details discussing the epistemological status of taxa: are they natural or artificial?

It is not solely the habit of elementary school teachers that many prehistoric animal groups have been popularly conceived as dinosaurs, such as ichthyosaurs, plesiosaurs, pterosaurs etc. At the making of their scientific taxonomy, *the true* dinosaurs were decided to be described as archosaurs with limbs held erect beneath the body. But today a majority of paleontologists reject the traditional style of classification in favor of the classical phylogenetic nomenclature. This approach requires that, for a group to be natural, all descendants of members of the group must be included in the group as well. Birds are thus considered to be dinosaurs and dinosaurs are, paradoxically, not extinct. So the common House Sparrow is a dinosaur! Luckily, one shouldn't take the classification rules too seriously.

Surely, there is certain complex philosophy underlying the differences between the Linnean, the Darwinian and the contemporary biology, the traditional and the classical taxonomy: taxon is treated either realistically or nominalistically; either morphologically or evolutionary (according to the current decision of International Society for Phylogenetic Nomenclature or whatever). The whole controversy can be summed up in favor of artificial criteria of classification.

### 3. Objectivism about explanation

Boghossian expresses his thesis as follows: “Under the appropriate circumstances, our exposure to the evidence itself is capable of explaining why we believe what we believe”<sup>20</sup>.

Unfortunately this sentence taken as an objectivity claim is self-refuting for it means that the impact of the evidence itself is valuable only *under certain conditions* hence not independently. We can easily reformulate it in terms of SE saying that for every rational choice of evidence used in explanation, there should be a number of negotiations and conventions accepted by the knowing agent or rather by the local scientific community.

Generalizing this thesis, we may say that the choice and subsequent use of evidence in explanation is like following a rule, which in turn represents a kind of scientific practice rooted in history and culture.

## 8. SE: What is Knowledge?

Talking about knowledge necessarily involves the notorious Nietzsche’s question: “Wer spricht?” Does philosophical approach to knowledge differ from the common sense one? It was already Plato to show that an unproblematic appeal to reality gives no foundation for knowledge definition, for the concept of reality is an implication of our knowledge. Knowledge cannot be deduced from a more general concept. Hence such definition should be descriptive. Thus knowledge is a philosophical category that describes the process of building the ideal or possible maps of activity and communication, creating sign-symbolic systems, mediating human interactions with the world and other people during the synthesis of different contexts of experience.

---

<sup>20</sup> Boghossian, P. *Fear of Knowledge*. New York, 2006, p. 19.

Human cognition is not a reflection of reality outside the man and mankind. It represents the content of collective activity and communication since their organization and functioning require the ideal, i.e. possible, tentative, approximate models and perspectives. This network of signs – scientific formulas, moral norms, images of art, magical symbols – is imposed upon the world.

At the same time knowledge structures the stimuli and reactions, orders actions and interactions providing a human being a possibility for his/her existence. Knowledge, consciousness, activity and communication represent internally interconnected elements of an open social system and can hardly be analyzed in a strong separation from each other. Hence epistemology is only in abstraction to be detached from philosophical anthropology, social philosophy and requires interdisciplinary interaction with the entire scope of the social sciences and humanities.

## **Conclusion**

SE seems to be a kind of synthesis of many different ideas and case-studies in philosophy and beyond. The achievement of SE is that it articulates clearly and consistently what many philosophers thought far from being social epistemologists.

Take, for instance, Donald Davidson's critique of the individualist epistemology. He asserts that the concept of objective truth ... "is accessible only to those creatures in communication with others. Third person knowledge – knowledge of other minds – is thus conceptually basic. But such knowledge is impossible without knowledge of a shared world of objects in a shared time and space. Thus the acquisition of knowledge is not based on a progression from the subjective to the objective; it emerges holistically, and is interpersonal from the start"<sup>21</sup> [Davidson 1991; 191].

So every clever realism includes at least some SE statements. And in turn the genuine ontology for SE can be dubbed a "communicative realism".

## **Acknowledgements**

I am greatly indebted to many of my colleagues, with whom we discussed main ideas of this paper, among them to Rom Harré, Tom Rockmore, Steve Fuller, Joan Leach and Jim Collier as well as to my students.

---

<sup>21</sup> Davidson, D. Epistemology externalized, in: *Dialectica*, vol. 45, № 2–3, 1991, p. 191.

**PHILOSOPHICAL CONCEPTS IN CONSCIOUSNESS:  
TRANSCENDENTAL IN DYNAMICS<sup>1</sup>**

In this paper the autopoietic model of consciousness is employed to analyze dynamic being of philosophical concepts. This being consists in permanent transformation within human mind. The autopoietic model of consciousness presupposes that consciousness builds itself anew in each moment of its duration, *durée*. It doesn't rest in immobility, but persists in becoming, and so maintains permanent assimilation and production of new meanings. Autopoiesis is viewed as a process of simultaneous loss and acquiring by creative consciousness of its identity. To keep identity for consciousness means to change without cease, i.e. to lose it to some extent.

A living human – empirical subject – that is subject possessing unique attributes: corporality, biographic situation, psychological and physiological features, individualized, different from others by his opportunities and abilities, belongs in a peculiar way to transcendental in Husserlian sense of “pure stream of consciousness as such”. Here I employ the concept of transcendental imagination to analyze phenomenon of imagination in respect of its contribution into being of philosophical concepts apart from numerous psychological characteristics of imagination.

---

<sup>1</sup> The work has been performed within the framework of Russian Scientific Foundation for Humanities' research project No. 13-03-00122a “Phenomenology of Meaning: Cognitive Analysis”.

## Autopoietic consciousness conception

Every consciousness is autopoietic. It means that in each moment of its duration – its *durée* – it builds itself up anew. It doesn't rest in immobility, but persists in becoming. Autopoiesis (derives from greek *αυτος* – “self” and *ποιησις* – which means “production, creation”). Autopoiesis was initially a biological concept, elaborated for living systems in 1973 by H. Maturana and F. Varela. Autopoiesis is a self-creation of a system, including reproduction of its borders and therefore its unity. Varela himself applies the model of autopoiesis to consciousness so constructing a processual dynamic model of consciousness. In Russia autopoietic model is applied to consciousness by H. Knyazeva<sup>2</sup>.

In philosophical context autopoiesis is viewed as a process of simultaneous loss and maintenance of its identity by creative consciousness for it must change constantly (and so loose its identity to some extent) to remain self-identical.

The above understanding of consciousness invokes the problem of consciousness' identity and provokes its reformulation: in this perspective the concept of consciousness identity becomes complex and resolves into a range of modes.

When applying the husserlian concept of “stream of consciousness” we may now state that the identity of consciousness is identity of a stream, which never remains the same (loss of identity) but keeps its unity as the stream (maintenance of identity).

The stream of consciousness is not homogeneous, it contains conglomerations, clots. Those are senses. Captured by net of relations, senses form systems of concepts (i.e. concepts are systems of senses). Things of the outer world are conceived by consciousness as concepts. If such a system is transformed (certain relations dissipate and others form) – the respective thing transforms itself for the consciousness as well (it loses certain features and obtains others).

Thus even day-to-day operating with things implies sense production and transformation within the stream of consciousness. The same is necessary for operating with concepts including philosophical con-

---

<sup>2</sup> Knyazeva, H. Nonlinear Cobweb of Cognition, in: *Foundations of Science*. 2009. Vol. 14. No. 3. Pp. 167–179 [in Russian].



cepts. An impulse from the outer world (a word, a phrase, a philosophical system) becomes a push for inner sense production, for a change of stream of consciousness in such a way that there appear new senses and new systems of senses. And those can be referred to this very outer impulse and can be processed and transformed.

Thus creative nature is proper for human consciousness, which constantly gives birth to new senses out of itself in its interaction with the world. The consciousness produces senses of each thing, of each action of the outer world as well as of each philosophical statement that it perceives from the outside. But sense in general would not exist if it is not new in every moment. For it can not be handed as a material thing. To view the world sensible consciousness itself must produce the multitude of senses and this means that in each act of sense-production it produces itself already new, inclusive of this new sense.

Thus we employ autopoietic consciousness model as a stream of senses, permanently transforming themselves, loosing and obtaining their links. Thought in general can be considered as a process of human senses creation. The husserlian concept of constructing – the base of transcendental analysis of consciousness' life – may be considered as identical to concept of creativity<sup>3</sup>. If we prescind psychological understanding of creativity as creative activity of a personal mind we may notice processes of phenomenological constituting within transcendently pure “essential” consciousness of transcendental subject of the phenomenological philosophy.

We consider consciousness as autopoietic stream that can exist and function as consciousness only due to persistent self-construction. E. Husserl after F. Brentano claims that consciousness is necessarily intentional: directed towards something. Consciousness always considers something. The problem is: what is this something of intentional consciousness? The object of intention may be indistinct, fuzzy (as in situation with groundless fear or anxiety) but nevertheless consciousness as far as it is always consists of senses is always consciousness of something. And these senses don't remain idle but change every moment. As far as consciousness doesn't hold its senses as a hand holds a

---

<sup>3</sup> Smirnova, N., Djomtchenko, L. Creativity as a process of senses creation, in: Creativity: epistemological analysis. Moscow, 2001. P. 91 [in Russian].

thing but contains them as they are immanent to it, the senses could not change without changing of the consciousness entirely. This is our conception of autopoietic consciousness. Autopoiesis in this case doesn't mean constant reconstruction of the same, but constant change that would be necessary for maintenance of consciousness as such. It can not keep being a consciousness without changing for life itself calls for permanent change of its senses. This change is obligatory to act in the world and to communicate with Others.

### **Action of transcendental imagination – transformation of concepts**

In philosophical concepts' being and transformation significant role belongs to imagination. I employ here the concept of transcendental imagination through analyzing of imagination phenomenon in the aspect of its contribution into dynamic of philosophical concepts, but presiding many of psychological features of imagination. I understand "transcendental" in husserlian sense as referred to "the pure stream of consciousness as such". The being of philosophical concepts which are systems of senses consists of their permanent creation, transformation, becoming, that take place in human mind through the work of imagination.

Philosophical concepts are complex ideal systems. They are complex in the chronological aspect of their developing within consciousness of subjects. They are systems of senses that appear in the stream of consciousness of empirical subject. The multitude of links between the senses within a certain concept as well as between different concepts actualizes itself through the transcendental imagination.

The work of imagination has reflective and non-reflective sides:

(1). Reflective side consists of deliberate reflection of a philosopher over his concepts and their links – this is constructing in its direct meaning.

(2). Non-reflective side, or unconscious processing as a psychologist would call it, also takes place within the stream of consciousness. It consists of chaotizing (derives from "chaotize" or "to bring into state of chaos") of concepts and their parts, which means weakening of their links, decomposition of their senses. The later can transform, change their configuration. Their spontaneous and sudden self-organization into other concept is called insight.

Speaking about chaotizing as weakening of links between senses I would like to emphasize, that sense is a smallest part of a concept, a singular perturbation in a stream of consciousness, resulting from reflection. Concepts are complex systems of senses linked with each other and thus keeping their stability within a stream of consciousness. The links may be of different firmness and some may get broken while the others may remain or form. The phase of weakening of a link is chaotizing of a concept. It takes place in a consciousness of subject only.

To make it possible for imagination to work with concepts the later must dissipate, their links must weaken. The smaller are the fragments in which the concept decomposes the more novel will be the concepts that will be composed of them through the work of imagination. The more old links will weaken, the more sudden will be the new. Though old links weaken in the phase of chaotizing, they never dissolve completely. And the new concept always drags a trace of the old one.

Prior to processing of a concept by imagination is interiorization of this concept – its creation in the stream of consciousness out of senses that appear through autogenesis when the impulse from outside is received in the form of verbal message. Senses and their systems are produced in consciousness like towards the outer impulses as a kind of attractor.

The old traces of senses and concepts created earlier are already present in the stream of consciousness. These are resources of senses of consciousness. Set of resources of senses of consciousness of individual empirical subject links closely with his “biographical situation”. These resources, their content and configuration result in already lived by empirical subject life and already created by his consciousness concepts. Old traces of senses and concepts, created earlier in stream of consciousness take part in creation of new concept.

The following steps of work of consciousness with interiorized, assumed concept that is the system of senses belonging to the stream of consciousness is chaotization and insight. Chaotization is the weakening of old links between senses within concepts as complex systems in stream of consciousness. Insight is a new understanding, self-creation of new concepts by reprocessing of chaotized senses.

Three stages of work of transcendental imagination – interiorization, chaotization, insight – stream one into another. So interiorization of external impulse by consciousness is in some measure the analysis, the

fragmentation that is initial phase of chaotization. Then each part of chaotized concept receives through associations new links with senses belonging to the stream of consciousness. Regrouping of elements of concept – insight – takes place, resulting in birth of a new concept.

The next necessary step of transformation of philosophical concepts – exteriorization: the concept flows from internal into the external plan. This step is necessary to ensure that transcendental imagination can continue the work with this concept in streams of consciousness of other subjects.

But every exteriorization is a collision of not-verbalized concept in stream of consciousness with material: words, other concepts in the same consciousness that the subject uses to express this concept, defend it, prove and transform it into the impulse for Others, for their streams of consciousness. As a result the concept verbalizes and transforms again, and so generates possibilities of external impulse for Others. So, transformation of concept in time represents a network with “knots” in consciousnesses of individual empirical subjects.

A living human – empirical subject – that is a subject possessing unique attributes: corporality, “biographical situation”, psychological and physiological features, individualized, different from others by his opportunities and abilities, belongs in a peculiar way to transcendental in E. Husserl’s sense of “pure stream of consciousness as such”.

Participation of individual empirical subject in transcendental does not mean that we understand empirical subject as totally transcendental. But empirical subject “transcends” into transcendental subject and his individual features become transcendental as much as consciousness of subject becomes arena of work of transcendental imagination with philosophical concepts.

The philosopher is the one who considers concepts, gives them interpretations in one or another way. He defends his point of view. But behind what seems to be constructing of concepts there is a work of transcendental imagination – self-transformation of a stream of the consciousness that creates different insights, involve the affinity of concepts by dynamic associations that have the result in “self-creation” of one concepts from the other or its parts. It is in this self-transformation of stream of senses that the work of thought with philosophical concepts consists.

## **EXTENSION OF DEFINITIONAL DOMAIN FOR TRUTH AND FALSEHOOD OPERATORS**

The aim of this paper is to construct an axiomatic theory of truth and falsehood operators, including the non-classical case. Their domain is a set of sentences, which then is extended to the set of symbol expressions of the language (Universe of symbol expressions). The construction of this theory is carried out in two stages: first, we introduce the axioms for the truth and falsehood operators; second, we extend the set of elementary formulae to the set of complex symbol expressions (strings of characters).

In general, the sentences do not necessarily have to be two-valued.

The classical logic is applied to the statements about the truth or falsity of sentences, which we will call TF-statements.

We restrict ourselves to the set sentences for which the truth and falsehood operators are well-defined. In this the proposed theory differs from Kripke's theory of truth<sup>1</sup>, in which the truth predicate is partially defined; another difference is due to the fact that Kripke accepts Kleene's non-classical logic for the metalanguage.

Iterations of truth and falsehood operators are allowed. Thus, the proposed theory of truth and falsehood operators differs from Tarski's semantic theory of truth.

---

<sup>1</sup> Kripke, S. Outline of a Theory of Truth, in: *Journal of Philosophy*, Vol. 72, No. 19, 1975. Pp. 690–716.

Note that the use of truth and falsehood operators instead of the corresponding predicates allows to avoid the liar paradox.

In the general case non-truthfulness does not necessarily mean falsehood, and non-falsehood does not necessarily mean truth. Operators of truth and falsehood will, therefore, be regarded as logically independent.

## 1. Truth and Falsehood Operator Theory

Alphabet of TFT:  $s, s_1, s_2, \dots$  – sentential variables;  $\neg, \supset$  – negation and implication;

$\forall$  – universal quantifier;  $\top, \text{F}$  – truth and falsehood operators;  $\langle, \rangle$  – technical symbols.

Formation rules:

1.1. If  $v$  is a sentential variable, then  $v$  is the formula.

1.2. If  $A$  is a formula, then  $(\top A)$  and  $(\text{F}A)$  are formulae.

Let us from the class of formulae select the subclass of formulae for which a classical logic would be implemented (called hereafter TF-formulae, abbreviated TF-f.).

2.1. If  $A$  is a formula, then  $(\top A)$  and  $(\text{F}A)$  is TF-f.

2.2. If  $P_1, P_2$  is TF-f., then  $(\top P_1), (\text{F}P_1), (\neg P_1)$  and  $(P_1 \supset P_2)$  are formulae and TF-f.

2.3. If  $v$  is a sentential variable and  $P$  is TF-f., then  $(\forall v P)$  is TF-f.

We denote the set of variables –  $\text{Var}$ , the set of formulae –  $\text{For}$ , set of TF-formulae –  $\text{TF-For}$ .

$A, B, C, \dots$  denote meta-variables for formulae;

$P, P_1, P_2, \dots$  denote meta-variables for TF-f.

D1. The conjunction  $\wedge$ , disjunction  $\vee$ , exclusive disjunction  $\underline{\vee}$ , biconditional  $\supset\subset$  are defined classically for TF-For.

A1. Axiom schemata of classical logic  $\text{CL}(\text{TF-For}, \neg, \supset)$

A2.1.  $\forall s P(s) \supset P(A)$ , if the formula  $A$  is free for  $s$  in  $P(s)$ .

A2.2.  $\forall s (P_1 \supset P_2) \supset (P_1 \supset \forall s P_2)$ , if  $P_1$  does not contain free occurrences of  $s$ .

Axioms which express the conditions of truth and falsehood for TF-formulae:

A3.1.  $TP \supset C P$ ,

A3.2.  $FP \supset C \neg P$

Rules of inference: MP, Gen. Definition of inference is standard.

We can prove the following theorems.

T1.1.  $(TA \underline{\vee} \neg TA)$ .

T1.2.  $(FA \underline{\vee} \neg FA)$ .

Tetralemma of truth and falsehood follows from the above dilemmas. It means that

*every sentence is either true and not false, or false and not true, or both true and false, or neither true nor false.*

Interpretation. Four logical values: T, F, B, N mean: true and not false, false and not true, both true and false, neither true nor false respectively (von Wright<sup>2</sup>: true but not false, false but not true, true and false, neither true nor false). The designated value is T.

P	¬P
T	F
F	T

⊃	T	F
T	T	F
F	T	T

A	TA	FA
T	T	F
F	F	T
B	T	T
N	F	F

<sup>2</sup> Wright von, G.H. Truth-Logics, in: *Logique et analyse*, Vol. 120, Nouvelle serie, 1987. Pp. 311–334.

The calculus TFT is sound and complete with the respect to the interpretation proposed.

The following theorem states the logical independence of the truth and falsehood operators.

$$T2.1. \neg \forall s (F_s \supset C F_t s),$$

$$T2.2. \neg \forall s (T_s \supset C F_f s).$$

Note that last theorems differ from the axioms of theory of truth KFG (Kripke-Feferman-Gilmore)<sup>3</sup> A2  $F(t) \leftrightarrow F(T(t))$  and A4  $T(t) \leftrightarrow F(F(t))$ .

Let us define implication of truth ( $\supset^t$ ), implication of non-falsehood ( $\supset^f$ ) and equivalence ( $\equiv$ ):

$$D2.1. (A \supset^t B) =_{df} (TA \supset TB)$$

$$D2.2. (A \supset^f B) =_{df} (\neg FA \supset \neg FB).$$

$$D2.3. (A \equiv B) =_{df} ((A \supset^t B) \wedge (B \supset^t A) \wedge (A \supset^f B) \wedge (B \supset^f A)).$$

T3.  $\neg \forall s (T_s \equiv s)$  T-equivalence does not hold in the general case.

Main theorem, which formulates the realisability conditions of T-equivalence.

$$T4. (TA \underline{\vee} FA) \supset C (TA \equiv A),$$

$$T5.1. \Pi A \supset C TA,$$

$$T5.2. FFA \supset C \neg FA \text{ (reduction theorem).}$$

MT1. For each formula, in which the truth or falsehood operators enter there is an equivalent formula with non-iterating occurrences of these operators.

Based on the latest metatheorem we can construct elementary theory of truth and falsehood operators ETFT<sup>1</sup>.

Formation rules of ETFT<sup>1</sup>

1.1. If e is a sentential variable, then e is the elementary formula.

2.1. If E is a elementary formula, then (TE) and (FE) are TF-f.

<sup>3</sup> Turner, R. Logics of Truth, in: *Notre Dame Journal of Formal Logic*. Vol. 31. No. 2. 1990. Pp. 308–329.



2.2. If  $P_1, P_2$  is TF-f., then  $(\neg P_1)$  and  $(P_1 \supset P_2)$  are TF-f.

2.3. If  $e$  is a sentential variable and  $P$  is TF-f., then  $(\forall e P)$  is TF-f.

Axioms and rules of inference of TFT are accepted except axioms A3.1–2.

## 2. Elementary and Non-elementary Theories

Tarski writes in<sup>4</sup>, “The fact that we are interested here primarily in the notion of truth for sentences does not exclude the possibility of subsequent extension of this notion to other kinds of objects”. Sentences are constructed using the grammar rules of the language. At present there are many languages and their corresponding grammars. However, no one has yet succeeded in discovering a grammar of natural language that would allow to separate the meaningful sentences from the meaningless ones. As Tarski put it, “we do not know precisely which expressions are sentences, and we know even to a smaller degree which sentences are to be taken as assertible”<sup>5</sup>. At the same time, all sentences are expressions of the language, so it makes sense to deal with expressions that extend the definition of truth and falsity operators to the universe of language expressions. This does not create any new problem, since the attachable expressions of language that are not sentences are neither true nor false. For example, Aristotle writes in<sup>6</sup>, “expressions which are not in any way composite such as 'man', 'white', 'runs', 'wins', cannot be either true or false”.

Symbol expression (word or string of characters) is defined as a finite linear sequence of symbols in some language.

Let  $\Sigma$  be a set of variables for the symbol expressions  $s, s_1, \dots$  and symbol constants  $c, c_1, c_2, \dots$ , i.e.  $\Sigma = \{s, s_1, \dots, c, c_1, c_2, \dots\}$ .

Let us now turn to the calculus of truth and falsehood operators  $ETFT^1(\Sigma)$  which defined to the set of symbol expressions.

---

<sup>4</sup> Tarski, A. The Semantic Conception of Truth: and the Foundation of semantics, in: *Philosophy and Phenomenology Research*, Vol. 4, No. 3, 1944. Pp. 341–376.

<sup>5</sup> Ibidem.

<sup>6</sup> Aristotle, *Categories*. 2a8–10.

Let us add the alphabet of  $ETFT^1$  with:  $s, s_1, s_2, \dots$  – variables for the symbol expressions of language;  $c, c_1, c_2, \dots$  – symbol constants.

Let us supplement the rules of the  $ETFT^1$  for the following:

Formation rules for  $ETFT^1(\Sigma)$ :

1.1. If  $v$  is a variable for the symbol expressions or constant, then  $v$  is the symbol expression (abbr. S-exp.).

2.1. If  $E$  is S-exp., then  $(TE)$  and  $(FE)$  are TF-f.

2.2. If  $P_1, P_2$  is TF-f., then  $(\neg P_1)$  and  $(P_1 \supset P_2)$  are TF-f.

2.3. If  $v$  is a variable for S-exp. and  $P$  is TF-f., then  $(\forall v P)$  is TF-f.

The axioms and rules of inference of the  $ETFT^1$ , extended to the set of variables for symbol expressions, are accepted. The result is theory  $ETFT^1(\Sigma)$ .

Tetralemma, extended to the universe of symbolic expressions, has been introduced in<sup>7</sup>.

**Language of S-expression with Concatenation.** Just as we are constructing complex sentences from elementary or atomic sentences, it makes sense to construct and consider complex symbol expressions. The role of connectives will be played by concatenation operation<sup>8</sup>. Here we restrict ourselves to pointing out a few provisions of this theory.

Let us add the alphabet of  $ETFT^1(\Sigma)$  with  $\wedge$  – concatenation operation.

Let us supplement the rules of the  $ETFT^1(\Sigma)$  for the following:

1.2. If  $S_1, S_2$  are S-exp., then  $S_1 \wedge S_2$  is S-exp.

Axioms and inference rules are the same.

The result is theory  $TFT^1(\Sigma, \wedge)$ .

<sup>7</sup> Pawlow, S.A. Einige nichttraditionelle Ideen in der Logik. Philosophie und Naturwissenschaften, in: *Vergangenheit und Gegenwart*. Heft 5: Philosophische Probleme der Logik, Berlin. 1978, s. 33–40.

<sup>8</sup> Corcoran, J., Frank, W., Maloney, M. String Theory, in: *The Journal of Symbolic Logic*, Vol. 39, No. 4 (Dec., 1974). Pp. 625–637.

In the above language  $TFT^1(\Sigma, \wedge)$ , which include non-elementary s-expressions and formulae, there are complex expressions of the form:  $S_1 \wedge S_2 \wedge \dots \wedge S_n$ , in particular, for example,  $c \wedge s_1 \wedge s_2$ , and respectively, the scheme of the formula  $T(S_1 \wedge S_2 \wedge \dots \wedge S_n)$ , the formula  $T(c \wedge s_1 \wedge s_2)$ .

T-formula with the occurrence of n character variables or constants may be considered as n-arity one.

Let us introduce the following abbreviations in the metalanguage:

Let  $S_1 \wedge \dots \wedge S_n$  is an S-expression, where  $S_i$  ( $1 \leq i \leq n$ ) is a variable or constant from  $\Sigma$ . Then

$$D3.1. T^n(S_1, S_2, \dots, S_n) =_{\text{df}} T(S_1 \wedge S_2 \wedge \dots \wedge S_n)$$

Previous formulae, taken as examples, will be:  $T^n(S_1, S_2, \dots, S_n)$ ,  $T^3(c, s_1, s_2)$ .

Thus, the elementary theory of truth and falsehood operators and its extension to universe of symbol expressions has been constructed and formulated.

*B. Pruzhinin*

## **RUSSIAN PHILOSOPHICAL TRADITION AS EUROPEAN: EPISTEMOLOGICAL STYLE OF INTELLECTUAL CULTURE**

This paper was prepared within the framework of definite ideological movements that are evolving today in Russian philosophy and should be seen in the context of these movements. There is no discussion of any special Russian epistemology. The case is the stylistic features of the development of epistemological problematics within the scope of one national philosophy tradition, which is different from other European philosophy traditions no more than Anglo-American epistemology from continental.

Modern Russian philosophy is going through the difficult period of self-discovery, restoration and development of its traditions. The history of Russian philosophy is full of gaps, drastic ideological turns, and even intellectual catastrophes. This creates the impression of lack of its own traditions and even of ideological integrity. However, the work to restore the continuity and ideological integrity of Russian philosophy has its own tradition and quite serious achievements. This work was extremely intensified in the 1990s. The two periods of this work can be marked out.

The first was the period of republication, initiated by the journal “The Problems of Philosophy” (“Voprosy Filosofii”), which created a series of “From the history of Russian philosophical thought”. At this time the works of philosophers, found outside the cultural life of modern Russia due to various reasons, were produced without specific comments and any analytical work. Commentators’ work has begun since

the late 1990s. Thoroughly annotated editions of individual philosophers began to go out, the monographs, articles and archive research, dedicated to the ideas and ways of Russian philosophy have appeared. And along with this work it became clear that the traditions of Russian philosophizing which were being restored could not be reduced only to individual names and certain ideological lines. The idea of Russian philosophy began to develop – Russian philosophy as the holistic cultural phenomenon, based on the intellectual tools of European philosophical tradition, but representing the problematic experience of Russia’s own reality, in the forms of its own cultural experience and theming.

Such a holistic understanding of Russian philosophy as the unified field of interaction between different ideological approaches – from religious to scientific, from the “Slavophile” to “Westernizing” – received a new impetus with the rethinking work on the experience of Russian philosophy of the Soviet period. But today there is a need for researchers to understand again the experience we already have – the work with the most difficult, “torn” time in the history of Russian philosophical thought – the first half of the twentieth century. The motion of Russian philosophy is sometimes called “an interrupted flight” and it was interrupted exactly in this period. Then the single space of thought and communication of Russian philosophers broke up, collapsed the space that has been deeply connected with European philosophical traditions. Today there is the intensive work on the resuscitation and underestimation of Russian intellectual culture traditions in the framework of research areas which emerged in the last decades in Russia, to promote, thus, the formation of the holistic cultural and historical image of Russian philosophy as polyphonic phenomenon of modern research in the manifold of research contexts.

The submitted paper on epistemological themes in Russian philosophy of 19–20 centuries is done within the scope of work described above together with T. G. Shchedrina. We attempted to identify and retrace in the historical dynamics the peculiarities of epistemological issues in a rather long period of Russian philosophy development as an integral phenomenon. In doing so we were aware of the complexity of the task. In the period chosen by us for investigation, epistemology never was realized as a crucial (link) theme of Russian intellectual culture. Nonetheless, in the process of analysis of philosophical texts of G. G. Shpet,

P. A. Florensky, S. L. Frank, N. Berdyaev, L. S. Shestov, L. S. Vygotsky, M. M. Bakhtin, J. M. Lotman, V. J. Kelle, V. S. Shvyrev, P. P. Gaidenko, V. P. Zinchenko, V. A. Lektorsky we managed to reveal the epistemological themes in the works of these thinkers and to follow some cross-cutting themes and echoing stylistic features in them. This research allows to talk about epistemological style in Russian intellectual culture and the peculiarities, characteristic to discussion of important philosophical-methodological problems of social-humane knowledge (the problems of historicism, objectivity and social-cultural relativity of knowledge, the relation of science and the humanities, rationality and scientific content of specific humane methods, peculiarities of interdisciplinary researches etc.) in the context of the ideological-methodological potential of Russian philosophy (including the second half of the twentieth century). The reason for taking epistemological category of the Russian philosophy of 19–20 centuries became for us the existence of combinations of ideas about the sign-symbolic nature of knowledge, and, therefore, opening the semiotic perspective in the investigation of the methodological problems of social-humane studies.

Modern methodology of social-humane studies (as, by the way, the whole philosophy of science today) is in crisis, it is unable to resist relativism, skepticism, notions of the significant scientific standards instability etc. However, the ideas of Russian philosophers, in our opinion, are now productive context, making possible the recovery of the humanities from recession. The research of methodological issues in Russian philosophy creates an opportunity, on the one hand, to understand deeper its substantial specificity, and on the other – to see the problems of modern epistemology of social-humane studies in a somewhat different perspective, discovering new, unexplored perspectives in philosophical-methodological literature. Modern understanding of the theoretical ideas of Russian philosophers, which combines value and epistemological aspects, extends the observation context of the epistemological status of the humanities and methodological potential of the humanities capacity in the way of cultural-historical scientific knowledge comprehension.

We think that we can present the promising outlook on epistemological analysis of modern humanities problems (philology, psychology, history), based on the philosophical-methodological experience of Russian

intellectual tradition, mentioned above, and reveal the actual opportunities it contains for the development of modern epistemology and methodology of social-humane studies. As it is known, European conceptual and notional tools were always used in Russian philosophy, and in this respect it could be fully correlated with the main directions of the world philosophy development, however, it had many features, because it was reflexively treating the problems of Russian reality. Modern research in the field of epistemology of social and humane knowledge is based primarily on Western European methodological experience. Generally, for this purpose most frequently used methodological schemes and concepts are: the phenomenology of Husserl, hermeneutics of G.-G. Gadamer, deconstruction of J. Derrida, “power-knowledge” of Foucault, communicative rationality of J. Habermas, “symbolic exchange” of Jean Baudrillard, “schizoanalysis” of J. Deleuze, social epistemology of S. Fuller, E. Goldman, D. Bloor etc. However, the methodological potential of Russian epistemological tradition cannot be completely reduced to the Western methodological settings. We proceed from the assumption that the adoption of methodological tools is not a simple transfer of Western thinkers ideas on Russian soil, but also their transformation in relation to the context of Russian tradition of “positive philosophy” (the term G. G. Shpet). A striking example of this is the philosophical and methodological concepts G. G. Shpet, P. A. Florensky, S. L. Frank, N. O. Lossky, transforming, each in its own way, the idea of phenomenology, acquiring a symbolic and semiotic perspective. As a result of these transformations not only the context of the problem is changed, but it acquires a certain specified character of epistemological categories content, which even today remain effective for the analysis of the methodological problems of the humanities.

Revealing the common ideological direction of the national philosophy in the context of Western European thought of that time, N. Y. Grot, in fact, in the program article in the first issue of “Problems of Philosophy and Psychology”, thus formulated its main aim: “...to build integral, stranger to logical contradictions, the doctrine of the world and of life, capable to satisfy not only the requirements of our mind, but also the needs of our hearts”. This philosophical project, named “positive philosophy”, was accepted by many Russian philosophers, very, very different in other respects. In the base of the “positive philosophy” was

the principle, presupposing the spiritual growth and enrichment of this tradition through the reference to the historical experience of national culture, naturally including both religious ideas and moral values and principles of the social structure of society. Incidentally, this approach found its expression in the relation of Russian philosophers to their professional activity – they saw it not as abstract, but as a way of concrete existence, a way of their life in philosophy. It is not surprising that in this professional context in general traditional for philosophy problem of communication was posed in a special, in its own way. The aspect of this problem was the question of truth, truthfulness in human relations, having obvious epistemological connotations.

Having addressed once to the specific areas of social-human studies, Russian philosophers formulated a number of ideas that exerted influence on the development of semiotics and structuralism, both in Europe and in Russia. This statement of productive influence of Russian philosophy on the formation of semiotic ideas are examined by us not as a local historical mishap (G. G. Shpet, R. O. Jakobson, L. S. Vygotsky), but as revealing one of the crucial themes of Russian philosophy, as demonstrating broad conceptual horizon, in which the historical reflection (“comprehension”) serves as the value of European culture. Certainly, the authors do not pretend to any completeness of the issue. Rather, the paper only designates the research contour of one ideological line of Russian philosophy. But made in this direction, as we see it, it lets us talk about the prospects, updating the stylistics of epistemological thinking in Russian intellectual culture of 19–20 centuries for contemporary to us philosophical-methodological reflection on science. And we believe that the array of such studies in philosophy of contemporary Russia will grow in different subject areas, restoring the internal integrity of Russian intellectual culture as of a peculiar component of European cultural tradition.



## NATURALISTIC CHALLENGE TO CONTEMPORARY EPISTEMOLOGY<sup>1</sup>

The philosophical reflection of modern science is marked by competition between two methodological programs: cognitive constructivism and “new naturalism”. Cognitive constructivism originates from I. Kant’s epistemology and acquired the most sophisticated philosophical development in E. Husserl’s transcendental phenomenology. Naturalistic epistemology, on the other hand, is implanted in the philosophical reflection of biological disciplines (K. Lorenz, F. Wuketitc, T. Riedl, G. Vollmer and D. Campbell). Evolutionary epistemology’s founding fathers suppose that cognition may be viewed as the “ideal vicariant” of any organism’s adaptation to its environment. Cognition is thought to be a specific information incorporation process, which allows an organism to interact with its environment in the optimal way.

The founders of evolutionary epistemology, emphasizing the significance of biological sciences for modern theory of knowledge, did not encroach directly on philosophical status of epistemology, but, using achievements of biological disciplines, promoted its further development (E. Mayer, J. Gibbson, M. Green, G. Stent, etc). In contrast to them, W. Quine<sup>2</sup> and his followers (among which A. Rosenberg, Kristianson, Hooker, and others are) believed that naturalized epistemology

---

<sup>1</sup> This paper has been done within the framework of the Russian Scientific Foundation for Humanities’ project “Phenomenology of Meaning: Cognitive Analysis” No. 13-03-00122a.

<sup>2</sup> Quine, W.V. Epistemology Naturalized, in: *The Psychology of Knowing*. New York, 1972.

must become the continuation of theoretical branches of psychology and deal with its most abstract problems. Quine's version of "epistemology naturalized" reduces philosophical epistemology to a particular cognitive science – Psychology of registration. The naturalistic challenge to the traditional philosophical theory of cognition manifested itself in criticism of the intentionality of cognition as well as of the attempts to redefine non-intentionally all the basic concepts of epistemology (cognition, verification, truth – lie, a priori – a posteriori, normativity), as well as in apology of naturalistic monism and criticism towards cognitive relativism.

Supporters of the strong version of naturalism in epistemology suggest refraining from use of the term "intentionality", which by no means can be re-interpreted in naturalistic way. They want to substitute it for non-intentional "information". It was also intended to ensure non-intentional content of basic epistemology concepts in terms of prediction and control. Meaning, which is obviously escaped from naturalistic redefinition, was seen as the subject to exclusion. Naturalistic epistemology reduces the problem of understanding exclusively to successful prediction. Following W. Quine, A. Rosenberg believes that semantically vague "depth of understanding" is nothing but empirically verified prediction power or predictively useful expectations. Naturalistic realism manifests itself as a struggle against "viruses of ideal objectivity" (E. Husserl).

Naturalized epistemology as a cognitive extrapolation of the Darwinian explanatory scheme interprets verification in terms of adaptation and survival. Accordingly, verification and control are supposed to be the ultimate purpose of any research for ensuring an adequate reference and ability to control behavior in the environment.

Indeed, our perceptions do have an adaptive significance and are selected in a way to increase fitness for the environment, and this makes naturalistic epistemology normative – but strictly in the instrumental meaning of the word. Furthermore, normative and descriptive judgments are internally interrelated and mutually assume each other's existence. Any empirical description presupposes the acceptance of certain scientific norms – rules for observation and experimental activity, interpretation of results, formation of abstract objects, which single out a certain set of

properties and relations, etc.<sup>3</sup>. They are always tacitly presupposed. The norm, or prescription, in its turn, is based on the interpretation of the actual state of things. But, unlike description, a norm is always based on a wider range of experience, which is not given in actual perception. It transcends the horizon of availability and leads to an area of generally significant, transcendental. Naturalistic interpretation of scientific norms fails to take into consideration an actual interdependence of normativity and descriptivity.

W. Quine believes normativity to be an attribute of “traditional” (i.e. “outdated”) epistemology for the reason that normative epistemology conclusions cannot be derived from factual psychological ones. According to W. Quine, epistemology is prescriptive only in the sense that its normativity is restricted to instrumental rationality. Following him, A. Rosenberg asserts that epistemology is actually no more normative than statistical method or engineering, which are verified not theoretically, but rather by deducing satisfactory or unsatisfactory predictions. He sees W. Quine’s shortcoming in his ignorance of normative element in traditional epistemology which naturalized epistemology tries to explain in terms of instrumental rationality – as the gradation of capabilities for successful prediction. Of two assertions, more “normative” is the one, whose contribution to prediction appears more significant. But, having accepted such instrumental definition of normativity, we can come to the conclusion that many false mental representations turn out to be more significant for their greater adaptive value, than true ones. Indeed, pragmatically justified false representations can turn out to be more useful for survival in comparison with cognitively more perfect truths, which have rather theoretical than pragmatic value. But does it mean that we can do without the concept of truth at all? Within the paradigm of naturalized epistemology it is what actually happens. Supporters of the strong version of naturalism assert that the search of truths cannot be viewed as an ultimate cognitive purpose. Most of mental representations they believe are true. However, many useful of them are definitely false, but close enough to the truth to increase adaptive power in a certain environment. J. Kim and F. Kitcher are, therefore, convinced that se-

---

<sup>3</sup> See V.S. Stepin’s “History And Philosophy Of Science” (M., 2011), p.198. for more details.

lection process formed our cognitive apparatus in such a way, that in the long-term perspective it produces not so much truths as “useful approximations” to the truth. And as the environment changes, these useful approximations take increasing significance for survival under the new conditions. I agree, that truth/false judgments can be irrelevant to the ability to ensure adaptive behavior, as well as that useful approximations can not only lead to adaptive success, but can also have adaptive advantage in a quickly changing environment. Yet, the extrapolation of this thesis on the process of logical deduction is definitely wrong. False premises, being built in deductive process, can lead to deductions, which are not only false but also dangerous to life. But this assumption appears to be in direct contradiction to the adaptive fundamentalism of naturalized epistemology.

W. Quine’s naturalistic epistemology eliminates the difference between analytical and synthetic, a priori and a posteriori. This elimination is based on the incontestable fact that all concepts of empirical judgments are theoretically provided in a sense that they are deeply implanted in the theoretical picture of the world. Yet, this true premise leads them to the wrong conclusion that the loss of pure empirical background means that the ultimate epistemological problem – justification – proves to be senseless. Furthermore, Kant’s a priori as dependence of cognition upon pre-experienced premises here acquires the evolutionistic interpretation as phylogenetic a posteriori. However, here we are obviously facing an evident philosophical vulgarization (simplification): not ontogenetic, but rather transcendental character is inherent in Kant’s a priori.

Naturalized epistemology is represented by its supporters as strictly monistic and irreconcilable with relativism. W. Quine was convinced that monism of naturalized epistemology is caused by its biological relevance and aspiration for the main and only purpose of cognition: prediction and control (interpreted in terms of biological adaptation). Therefore, the very idea that various cognitive systems can be equally preferable in the same environment is denied as meaningless: other environment will select other adequate means for the main cognitive purpose. However, some features of cognitive systems show their selective nature (if any) in the quite long-term perspective, which is not so much natural as cultural for human beings.

Human cognition constitutes the set of cognitive formations whose nature cannot be characterized as adaptive ones. Thus, the methodology of science is definitely historically changeable, whereas human biological evolution is mainly completed long before the time of science's birth. W. Quine's philosophically unpretentious argument that as biological and information environment change, local selective forces stimulate one cognitive styles more than other ones, can hardly be considered as an exhaustive explanation due to the fact that not all features of cognitive systems may be seen as the results of selection. Concepts and theory formation process inevitably "transcends" (goes beyond) reality, involves social imagination and rationally organized fantasy.

The cognitive absolutization of adaptive and selection fundamentalism is criticized also within the framework of naturalized epistemology itself. For example, Kristianson and Hooker try to integrate variational, selectionistic and retentional (VSR) epistemology to the modern communicative paradigm in the theory of knowledge. They rightly believe that adaptiveness and cognition modeling exclusively in terms of correspondence completely ignore the importance of communication and learning processes. The more complex an organism is the higher the significance of interactive learning processes in forming its epistemic capabilities proves to be. Thus, the highest cognitive capabilities (e.g. intellectual) must find their explanation in terms of interactive learning, as organisms' interaction not only with their environment, but also with each other. It means that evolutionary epistemology's further development should be focused on supplementing its selectionist paradigm with modeling organization of communicative process and interactive anticipation. I doubtfully think that naturalized epistemology would be able to incorporate communication and learning-based models without radical re-interpretation of its basic cognitive principles and ontological assumptions.

How the above described tendencies in naturalized epistemology can be estimated? Apparently, we should welcome the fact that contemporary naturalized epistemology transcends narrowing framework of adaptive and selectionist fundamentalism's explanatory scheme in favor of some more multidimensional and philosophically more sophisticated theory of cognition, which stresses communicative and learning conceptual significance. Our cognitive apparatus serves more specialized social

and cultural purposes, which only indirectly may be viewed as an instrument for the best adaptation – natural or social one. The data about colossal redundancy of our cognitive capabilities over adaptive needs, which have been obtained by modern cognitive sciences, testify that human cognition can and do stretch far beyond its Umwelt or E. Husserl's Lebenswelt.

Estimating the heuristic power of naturalized epistemology, we have to take into consideration the significance of the most philosophically sophisticated 20<sup>th</sup> century's philosophical conception of cognition – phenomenology, which is intentional in its initial premises. In one of E. Husserl's latest works (“Cartesian Reflections”), which cover phenomenological constitution, the extremely complex process of “meaning creation” from transcendental Ego's cognitive resources is shown. Some aspects of the process still remain debatable (the problem of phenomenological constitution of Alter Ego, or transcendental intersubjectivity). And phenomenological description of transcendental subject's constitutive activity by its philosophical significance cannot even be compared with the simple reference to the activity of adaptive mechanisms.

It seems reasonable to ask whether a productive synthesis of phenomenology's achievements with the data of corporal-oriented approaches in epistemology is possible in principle? E. Husserl himself believed that recognizing human body (der Körper) paves the way to analogizing apperception in his theory of transcendental intersubjectivity (Alter Ego's existence). However, “indifference to premises”, i.e. the disregard of non-eliminative differences between fundamental cognitive and ontological assumptions of both cognitive projects, inherent to modern “phenomenology of corporeality”, could hardly be successful. Most likely, it makes sense to talk about some aspects of their complementarity, while the leading role of Kant's and Husserl's epistemology in contemporary theory of knowledge is thought to be definitely preserved.

## **PERSONAL IDENTITY IN THE AGE OF MASS COMMUNICATION**

First of all I need to make clear what I mean when I speak of identity, for ‘identity’ today is a vague and popular term, which is mostly used in the context of national or ethnical identities, having thus mostly political or even ideological meaning. Although this aspect of identity is quite important, I would like to speak on another subject. My subject of interest is personal identity, by which I understand the continuity, integrity, consistency of the individual inner life. Identity is what helps a person to be sure that all the events of person’s life, all the thoughts and feelings, even controversial ones, belong together to one being. A person, describing oneself, trying to find one’s place in the world, relies on many different identifications which are formed on different foundations – each person identifies oneself with certain sex or gender (sexual or gender identification), with certain nationality or ethnos (national or ethnical identification), with certain country (civic identification), with certain social group (for example, it can be class or professional identification) etc. Each of these identifications can be important at one moment and unimportant at the other (for example, my national or civic identity is more acute when I’m in the foreign country than among my co-citizens, except the situations when the country calls for my patriotic feelings), but still I don’t cease to be a woman or a Russian at any given moment, there are no “if”-s in identity, there are just “and”-s, which means “I am that, and that, and that also, and no one can take it from me”. Apart from these basic identifications that reflect our principal biological and social characteristics, there are more narrow and precise

identifications that appear through our interactions with other people. Each person whom we encounter and interact with makes us form special identification or special Self-image, that is oriented exactly towards a certain person or a group of persons. And with the growing number of social interactions due to the changes in modern world that will be considered below, the number of such identifications also grows, and when we speak of modern personal identity, we should speak of its plurality.

The problem is that the more complex the identity becomes, the more different identifications it tries to unite, the more it succumbs to what one can call blurred identity or crisis identity. And in our days as probably never before many challenges appear that threaten the stability of personal identity.

There are many traits in modern society<sup>1</sup> that are responsible for such situation. I will name the four of them that I consider principle. They are:

absence or blurredness of the group of social identification;

moral and cultural relativism;

development of mass media and mass communication;

development of virtual communication.

I will now elaborate these four points.

1) Unlike previous ages when social identification was virtually prescribed from the birth, in our age of unprecedented social mobility, in the age of parity of sexes, social identification becomes blurred. It might change many times during our life, and now it doesn't directly depend on birth, social class or cast, but is mostly defined by two criteria – economical status and profession. In theory these two should more or less correspond with each other – people of the same profession are also of the same economical level, and professional identification also comprises the feeling of level of social importance.

2) Point 2 actually derives from point 1. The changes of modern society lead to the situation where “anything goes”, all social positions are equal and right. In the situation of globalization, extensive cultural

---

<sup>1</sup> Giddens, A. *Modernity and Self-Identity. Self and Society in the Late Modern Age*. Cambridge, 1991; Bauman, Z. *The Individualized Society*. Cambridge, 2001.



exchange and merging of cultures also leads to the decrease of local cultural significance, a person loses his culture of identification. The variety of the acceptable forms of social life, the cultivation of the individuality has its dark side: it leads to the situation where there are no exact ideals, no common values, no rules except those represented in the law. And the absence of exact moral values and ideals can lead to one of the most deep-rooted identity crises.

3) The rapid development and evolution of mass media and mass communication resulted in the immense amount of information that a person should deal with<sup>2</sup>, and it became quite problematic to choose the right information from wrong, to choose truth from lies. Mass media, despite its noble function to bring the news of the world, is more efficient in other roles – such as: sharing questionable facts, opinions, advertising either products or ways of life, and, what is most dangerous – spreading obscurantism. Most viewers are “naïve viewers” – a person tends to believe what she or he sees with her or his own eyes, even on TV, and not many people apply critical approach towards it. So for many individuals whatever is on TV becomes a real thing, and for those who have critical approach the situation turns to be hard: mass media has so often lied to or misguided its consumers, so can we ever believe anything that they tell us about? And if we can’t believe anything about the world outside our local environment, what should we identify ourselves with in the bigger picture?

4) The information field of mass media grows even wider with the development of Internet. It adds to the chaos. When there are hot news (usually they concern some scandals or catastrophes), you can make a research and find hundreds or even thousands of news portals that will tell you about this particular even in hundreds or thousands different ways. Once again – whom to believe?

But there is other thing about Internet, which is even more interesting to the question of the personal identity. It’s the virtual reality that it creates. It provides the users with the possibility to create fake Self-images, fake-identifications, even fake-identities. They shouldn’t be really fake in fact, so we better call them virtual identities. Modern

---

<sup>2</sup> McLuhan, M. *Understanding Media: The Extensions of Man*. New York, 1964; Luhmann, N. *The Reality of the Mass Media*. Stanford, 1995.

Internet of the age Web 2.0<sup>3</sup> is based on interactions between users that are possible not only through forums, chats, instant messengers etc., but through the building of their own blogs with their own “profiles”, where they can try to represent themselves in some carefully chosen aspects of their real lives. Internet doesn’t just reflect the real social life, it creates a social life of its own, that abides its own rules. There is more security and thus more permissiveness, for nobody can really know what, who or where you are. Each person creates an image which is only partly truthfull if not completely made-up. The real and virtual worlds interwind, virtual communications start gaining more and more importance, and thus my identity should comprise not only events of my real life, but of my virtual life as well. For “myself” is also my texts that belong to me in that virtual world, discussions I took part in, communities of interests I belong to, etc.

These are the main reasons that modern identity is constantly challenged in its stability, continuity and integrity. R. J. Lifton, american psychiatrist and author of the conception of “protean identity”, describes modern person as feeling “homelessness” or “fatherlessness”, because in this versatile, ever-changing world, where you can rely on nothing, when its hard to have any stable identifications, one feels her- or himself lost<sup>4</sup>. But this situation described above is not just a threat for the identity. In fact, it has lots of advantages. Modern person can choose what she or he wants to be, all the doors are open, and information resources are so immense that a person is able to widen her or his horizons, to develop a more versatile view of the world. But to keep identity stable, to avoid identity crises, to know one’s place in this world, modern person should face many challenges, be ready for them and put more efforts into braving them.

---

<sup>3</sup> O’Reily, T. *What is Web 2.0* <<http://oreilly.com/web2/archive/what-is-web-20.html>>.

<sup>4</sup> Lifton, R. J. *The Protean Self. Human Resilience in an Age of Fragmentation*. New York, 1993.

## II. PHILOSOPHY OF SCIENCE

*V. Stepin*

### THE HISTORIC TYPES OF SCIENTIFIC RATIONALITY

In historic evolution of science one can identify stages characterized by different types of scientific rationality. One can distinguish between three such types: the classical, the non-classical and the post-non-classical rationality.

The distinguishing criteria are: 1) the specific features of the systemic organization of objects considered by science (simple systems, complex self-regulating systems, complex self-developing systems), 2) the specific systems of ideals and norms of inquiry characteristic of each type of rationality (explanations, descriptions, substantiations, knowledge structures and constructions), 3) the specific character of philosophical and methodological reflection of the cognitive activities that ensure the incorporation of scientific knowledge into the culture of the respective age.

#### The Classical Rationality

At the stage of classical science the main objects of inquiry are simple systems. Their understanding rests on a specific conceptual framework. In order to describe *simple systems* it is enough to assume that the properties of the whole are the sum total of the properties of the parts. The assumption is that the properties of an entity remain unchanged regardless of whether the entity in question is considered as a part of a whole

or as an independent entity. The relationship of an object and a process is interpreted in a specific way, viz. the object (the thing) is primary, the process being but an impact of one thing onto another. Causality is thus reduced to Laplacian determinism. Space and time appear as something external to a systems (an object) unaffected by the latter's states and changes. This conceptual framework was sanctioned by the mechanistic philosophy that formed the philosophical basis of the scientific knowledge of the time. It was not limited to physics: biological and social objects were likewise seen as simple mechanical systems.

The cognition of all types of systemic objects requires a specific structure of operations and means, the specific features of which shape the interpretations of the ideals and norms of science. According to the prevailing idea of classical science, explanations and description dealt with the properties of the objects of inquiry only: no reference was to be made to the values and goals of cognition, its particular means and procedures. Violations of those principles was seen as a threat to scientific objectivity.

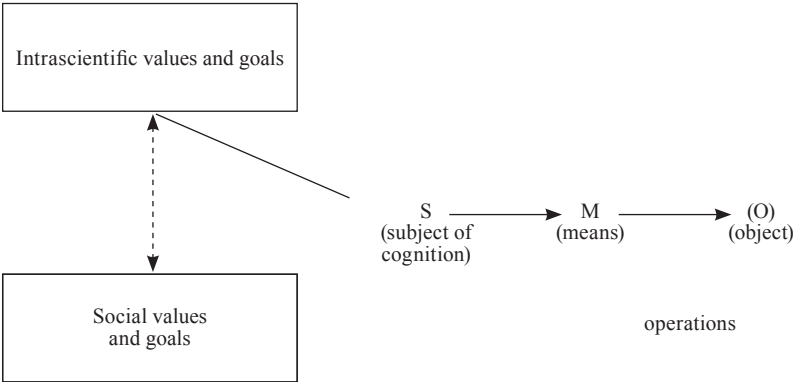

Fig. 1. The classical type of scientific rationality

The core epistemological notion of the classical science was that of cognition as observation and experiment targeting natural objects that yield their secrets to the inquisitive mind. Mind thus acquired the status of sovereignty. Ideally, it was seen as a remote agent that

observed and studied objects external to itself and remained generally unaffected by anything except the properties and characteristics of the objects of inquiry.

### **The Non-classical Rationality**

The main objects of inquiry for non-classical science are complex self-regulating systems. They are differentiated into relatively autonomous subsystems where mass stochastic interaction of components takes place. The system's integrity is secured by a special control unit, its feeds and feedbacks to and from the subsystems. Large systems are homeostatic. Examples of large systems in technology are automatic machines, automaton-factories, systems of spacecraft control, automatic systems of cargo flow regulation that use computer programs, etc. Examples from life and society are organisms, populations, biogeocoenoses, social objects seen as self-reproducing organized entities.

The conceptual framework for dealing with complex self-regulated system is different. The whole is no longer equaled to the properties of its parts, but is seen as possessing a systemic quality of its own. Parts, too, are seen as possessing different properties when operating inside or outside of the whole. The relationship of an object and a process is also seen differently. Complex systemic objects are viewed as processual systems that reproduce themselves in the course of interaction with the environment thanks to self-regulation. Causality in large self-regulating systems can no longer be reduced to Laplacian determinism (which is of limited relevance here); it is expanded to include "probabilistic" and "final" causation. The former takes into account the stochastic nature of interactions in the subsystems; the latter engages self-regulation as a means of achieving the goal of the system's reproduction.

New meanings appear in the spatial-temporal descriptions of large self-regulating systems. In certain situation the idea of time is to be expanded to include, in addition to the "external time", the "inner time" (biological clock and biological time, social time). In correlation with the new type of objects of inquiry, a new interpretation of the ideals and norms of science has been formed. The non-classical science correlates its ontological postulates and the characteristics of

its methods of inquiry; it allows for explanations and descriptions that contain explicit references to means and operations of cognition. The foremost example of this new approach is provided by the ideals and norms of explanation, description and demonstration adopted by the quantum-relativistic physics.

Contrary to the classical physics that sought to describe and explain the object “in itself”, without reference to the means of inquiry, the quantum-relativistic physics requires explicit indication of the means of observation as a *conditio sine qua non* for the objectivity of the explanation and description (the classical approach may be seen then as an idealization, of which the rational aspects are generalized within the new approach).

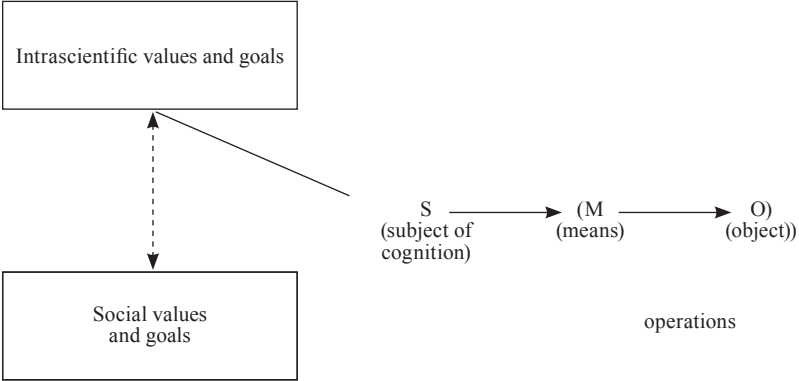

Fig. 2. The non-classical type of scientific rationality

The epistemological basis of the ideals and norms of the non-classical science is the notion of the activist nature of cognition. The cognizing mind is no longer seen as distanced from the world to be understood, but as a part of the latter and determined by the latter. It is realized that the nature’s answers to our questions depend not only on what nature has to answer, but on our way of asking (W. Heisenberg). This way is, in its turn, determined by the historic development of the means and methods of our cognition and practice.

## The Post-non-classical Rationality

The strategy of the development of contemporary (post-non-classical) science is determined by the cognition of complex self-developing systems. Self-developing systems present an even more complex type of systemic integrity than the self-regulating systems. This type of systemic objects is characterized by the development resulting in transition from one kind of self-regulation to another. Here self-regulation stands out as an aspect responsible for the stability of the developing system. A shift in the kind of self-regulation is a phase transition which may be characterised in terms of dynamical chaos. In contemporary science it is described in the framework of the dynamics of nonequilibrium systems and synergetics.

This type of systemic objects is characterised by hierarchical structure of levels of elements and the ability to generate new levels. Each of these new levels affects the previously existing ones, restructures them, the system acquiring a novel integrity.

The system is differentiating with the emergence of new levels and the formation of new relatively autonomous subsystems. The control unit is restructured, too, with new parameters of order and new types of feeds and feedbacks emerging in the process.

These alterations in the structure of self-developing systems can be presented by means of the following diagram:

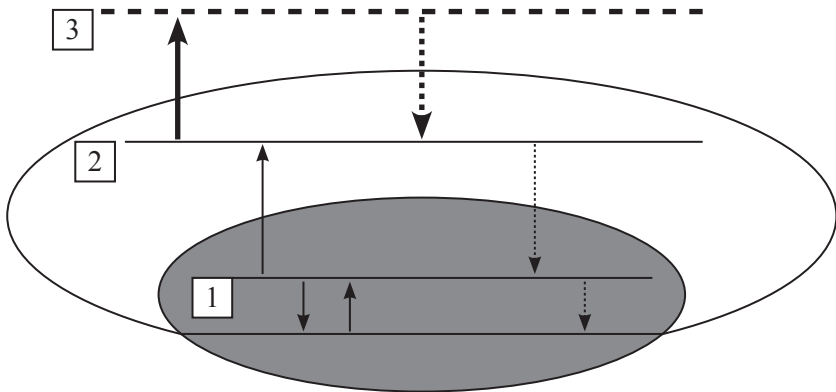

Fig. 3. Alterations of the structure of self-developing systems

1. *Initial self-regulation (self-regulation 1)*
2. *A new type of self-regulation based on the transformation of preceding levels of the system hierarchy (self-regulation 2)*
3. *A potentially possible level of organization on prolongation of the development of system as a chance for the new type of self-regulation (Potential self-regulation 3).*

Complex self-developing systems are characterised by openness, by exchange of matter, energy and information with the external environment. The cognitive and technological mastery of complex self-developing systems starts to determine the frontline of science and technology. Examples of such systems are biological objects, considered now not only from the perspective of functioning, but also from that of development; objects of contemporary biotechnologies, especially genetic engineering; systems of contemporary design engineering that deal not only with this or that technological system, but with the even more complex dynamic sets encompassing humans plus technological systems plus ecological systems plus the cultural environments that accommodate the new technologies – all viewed in interdependent development.

Other salient examples are contemporary complex computer networks based on the man-machine dialogue, “the global Web” and, last but not least, social objects viewed in their historical evolutions.

The second half of the 20<sup>th</sup> century saw physics turning to the study of this kind of systems.

On the one hand, the development of present-day cosmology (the Big Bang Theory, the theory of the inflationary Universe) introduced the notion of the emergence of various types of physical objects and interactions. On the other hand, the concept of objects in evolution was actively elaborated within the thermodynamics of nonequilibrium processes (I. Prigogine) and synergetics. The reciprocal influence of those two research trends established the notions of self-organization and self-development as an integral part of the vocabulary of physical science.

Again, a new conceptual framework was required to express these developments. The categories of the part and the whole acquired new dimensions. With the formation of new organization levels the system’s origi-



nal integrity is transformed and new parameters of order emerge. To put it otherwise, it is still necessary but no longer sufficient to highlight the systemic quality of the whole: this notion must be supplemented with the notion of transformation of the very type of systemic integrity in the course of the system's development.

When dealing with complex self-developing systems, further reconsideration of the object-process relationship is needed. The growing system's complexity resulting from the emergence of new levels of organisation means change of the very invariants, transition from one type of self-regulation to another. Henceforth the processual character of the object (system) becomes two-dimensional: it is both self-regulation and self-development as a transition from an earlier type of self-regulation to a new one.

The notion of "causality" is also expanded. It now focuses on the transformation of possibility into actuality. "Final" causation understood as a means of self-regulation and reproduction is supplemented with the idea of directed development. This "directed development" should not be interpreted as fatal predetermination. Casual fluctuations at the systems' restructuring phases (at bifurcation points) form attractors that operate as a kind of guide programs prompting the systems towards new states and changing their fields of possibilities (probabilities) closing some of the former options and opening new ones. New levels of organisation born out of the old ones now affect the predecessors, the effect functioning as the cause (circular causality).

Notions of space and time acquire new dimensions, too. The build-up of new organisational levels is accompanied by the change of the system's inner space-time. In the course of the system's differentiation and formation of new levels a kind of "space-time windows" appear that set stability limits for each of the levels and prediction horizons for further changes.

Reorientation of contemporary science towards the study of complicated developing systems has affected the ideals and norms of scientific inquiry considerably. The historical character of systemic complex objects and variability of their behaviour call for special methods of description and prediction, viz. scenarios of possible developments at bifurcation points.

The ideal of theory as an axiomatic-deductive system is challenged by theoretical descriptions based on approximations and theoretical schemes using computer programs, etc. Natural sciences borrow from the humanities (history, archeology, historical linguistics and the like) their method of historical reconstructions now viewed as a special type of theoretical knowledge.

Examples of historical reconstructions are now found well beyond the traditional “evolutionary” disciplines (such as biology or geology), in cosmology and astrophysics: contemporary theories of Metagalaxy are, in fact, attempts at historical reconstruction meant to model the principal stages of evolution of this unique object.

Salient among historically developing systems of interest to contemporary science are natural and social complexes that include man as their component. In studies of such “man-measured” objects, the search for truth becomes intrinsically linked to elaboration of strategies of potential transformations of the objects of inquiry, which directly affects humanist values. Such systems allow for no free experimentation. Their research and practical use are subject to certain limitations, including bans on interaction strategies of potential danger to humankind.

In contemporary program-oriented research this explication takes the form of the programs’ and projects’ social expertise. In defining the limits of potential interference with the object of research, the researcher cannot avoid solving a number of ethical problems. Ethical expertise becomes an integral component of the justification of scientific knowledge.

This cannot help affecting the ideal of value-neutral research. As far as such “man-measured” objects are concerned, “objectively true” explanations and descriptions not only allow, but presuppose axiological dimension. Intrinsic scientific values of search for truth and accumulation of knowledge have to be explicitly linked to extrascientific (general social) values.

The epistemological foundation of these new ideals and norms of science is the notion of science as a cultural and social phenomenon subject to cultural and social values. Scientific work is now viewed in social context and with regard to its social consequences, both dependent on and affecting their general states, value orientations and worldview attitudes.

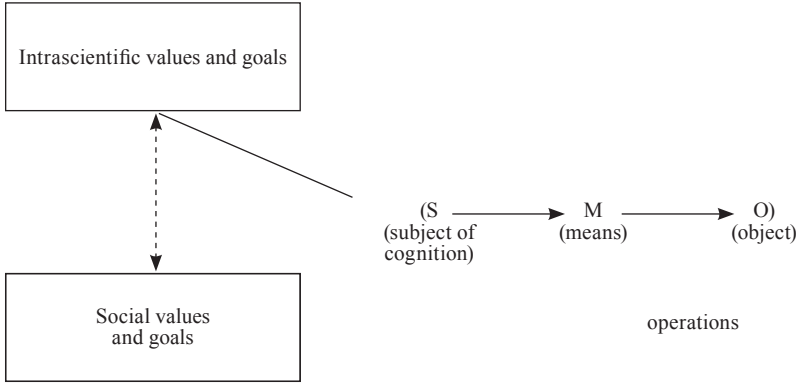

Fig. 4. The post-non-classical type of scientific rationality

The three major stages in the historic development of science, each the outcome of a global scientific revolution, are characterised by three types of scientific rationality that follow each other in the history of technogenic civilization. However, the development of a new type of rationality, has not resulted in complete disappearance of its predecessor, but has only limited the latter's sphere of application to problems of certain types.

Mastering complex self-developing systems advances a whole series of new and at times unexpected problems not only of methods, but also of Weltanschauung.

For a long time science and technology in modern European cultural tradition used to develop themselves so that they would correspond to the Western value system only. Now it is discovered that contemporary type of scientific-technological development could be agreed with some Weltanschauung ideas of Eastern cultures, which are alternative and it might seem alien to Western values. Here I would like to denote three major points.

First, Eastern cultures were always based on the conception that natural world where human lives is a living organism and not a depersonalized inorganic field that could be ploughed up and altered. For a long time modern European science used to consider such ideas as remnants of myth and mysticism. But after the development of contemporary ideas

of biosphere as the global ecosystem it was found out that our immediate environment is indeed an integrated organism, human being included into it. Such notions already begin to resound with organismic images of nature inherent to ancient cultures.

Second, objects representing developing human-dimension systems require special activity strategies. The aim at active forced transformation of objects is no longer effective when dealing with such systems. Simple increase of external force pressure is not capable of generating anything new but reproduces still one and the same set of structures. And under nonequilibrium states, in bifurcation points, small prick-influence in a certain space-time locus can cause (due to cooperative effects) new structures and organization levels. That way of influence resembles non-violence strategies elaborated in Indian cultural tradition, as well as actions based on “Wu-Wei” principle that proclaimed the ideal of minimal action grounded on feeling the resonance with world rhythms (ancient Chinese parable of a “sage” who tried to hasten the growth of plants by pulling them out of the ground was the vivid demonstration of what could be the results of violating the “Wu-Wei” principle).

Third, strategies of dealing with complex human-dimension systems lead to the becoming of a new type of integration of truth and morality, purpose-rational and value-rational action.

For a long time the ideal of true knowledge as a value in itself that does not need any additional ethical substantiation dominated over Western cultural tradition. What is more, rational substantiation was believed to be the foundations of ethics. When asked how to live virtuously, Socrates used to answer that first we have to understand what is virtue. In other words, true knowledge of virtue assigns guidelines for moral behavior.

Fundamentally different approach is inherent to Eastern cultural tradition. Truth was not separated from morality there, and moral perfection was assumed as the condition and the ground for comprehending the truth. The same hieroglyph “Tao” denoted law, truth and moral course of life in ancient Chinese culture. When Confucius was asked how to understand Tao, he would give different answers to each one as each of his students had passed over different path of moral perfection.

Post-non-classical rationality clear the way for reconciliation of those two approaches (Eastern and Western cultural traditions).

Thus, growth points of new values and Weltanschauung orientations that clear new perspectives for the dialogue of cultures emerge on the front line of scientific and technological development owing to mastering complex self-developing systems. And that dialogue is considered by many today as necessary for elaborating new strategies of vital activity of the globalizing humankind, in order to find the way out of global crises caused by contemporary technogenic civilization.

## **GALILEO GALILEI AS PHILOSOPHER OF TECHNOLOGY AND TECHNOLOGY ASSESSMENT EXPERT<sup>1</sup>**

Three main features of engineering thought have formed over the centuries: artistic, practical (or technical), and scientific. The traditional guild-regulated crafts were gradually replaced by science-based engineering activity. Technology comes to a point from which its further advance is impossible without its saturation with science. Knowledge was then considered to be a real power and the engineer its holder. Galileo was directly associated with engineers and technicians of the Renaissance. For years he built scientific instruments and carried out tests in a workshop in his house in Padua. Padua was in the Republic of Venice, and Galileo maintained constant contacts with the Venetian arsenal (Fig. 1).

In the Renaissance time the relation between art and nature to each other were interpreted in three different ways. “The conception of nature dominating over *techne* was formulated, for example, by scholastic philosophers on the thirteenth century <...> Aristotle himself introduced no contrapositions between the laws of mechanics and those of nature <...> The third position, according to which art tends to dominate over nature, started emerging in codified form during the second half of the sixteenth century and was supposed and proclaimed mostly by educated engineers”. These artist-engineers “were engaged

---

<sup>1</sup> This article is prepared for the project „From Galileo’s technoscience to the nanotechnoscience (philosophical and methodological analysis)“ No. 13-03-00190 of the Russian Foundation for Humanities

in great enterprises like changing the course of river” and received “the impression of being deployed against nature”. “Galileo supports the idea, that ...

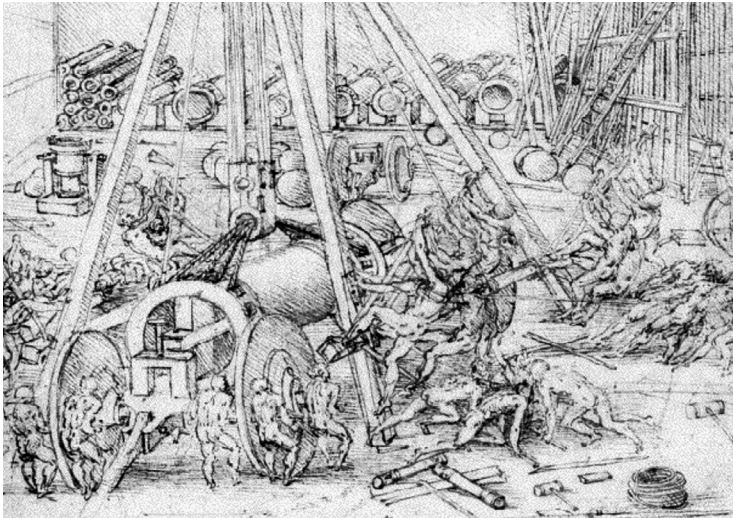

Fig. 1. The Venetian Arsenal<sup>2</sup>

laws of nature and laws of mechanics belong to the same domain”<sup>3</sup>. He criticized the craftsmens’ approach to technical activity that overlooked scientific knowledge and the laws in building machinery to works of their own nature impossible. The main reason for those errors was that practical engineers who developed their inventions on false foundations deceived nature, failing to see its basic laws.

The rapid development, of the states and trade promoted improvements in military technology, mainly fortification and artillery; the construction of water works and civil engineering structures; the manufacture of machines, including ingenious mechanisms and automatic devices for entertainment. The development of artillery and fortification was es-

<sup>2</sup> Leonardo. *Art and Science*. Florence: Guinti Editore, 2005.

<sup>3</sup> Valleriani M. *Galileo Engineer*. Dordrecht, Heidelberg, London, New York, Springer, 2010. Pp. 200–203.

sential to the existence of the cities and republics in Italy; their independence often relied on the accuracy and range of their cannons and the strength of their fortification. Therefore, engineering consultants were in demand everywhere and were valued by kings, dukes, and citizens.

But traditional artisan skills were no longer enough. That is why the first engineers and inventors turned to mathematics and mechanics, where they got knowledge and borrowed calculation methods. When that knowledge was insufficient, they tried to obtain new knowledge on their own, often becoming very productive scientists. Knowledge was then considered to be a real power, and the engineer its holder. An invention or even a painting was, for example for Leonardo da Vinci, not merely a product of imagination, a semiartistic inspiration, or a blind adherence to craft traditions; it resulted from a careful study of nature and its laws. Some his “draft projects” were based on careful studies of nature. He wrote: “Those, who are not in love with practice without knowledge are like the sailor who goes into a ship without a rudder or compass and who never can be certain whether he is going. Practice must always be founded on sound theory”<sup>4</sup>. “Leonardo was original also in his drawings which, even in their incompleteness, are correctly interpreted as the conceptual equivalent of the ‘model’...” (Fig. 2).

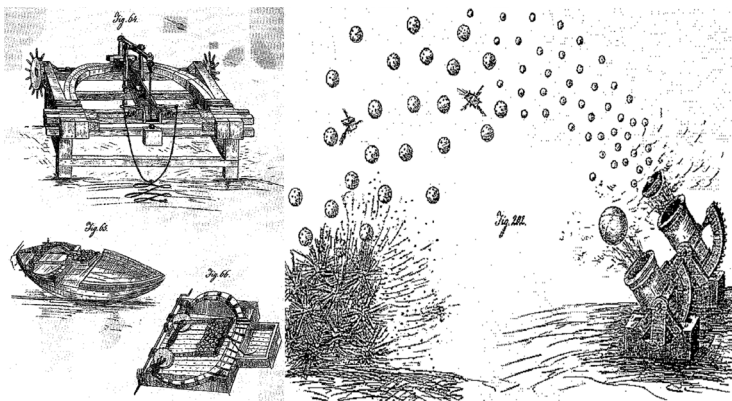

Fig. 2. Leonardo. The machines engineering drawing<sup>5</sup>

<sup>4</sup> Parsons W.B. *Engineers and Engineering in the Renaissance*. Baltimore: The Williams & Wilkings Comp., 1939. Pp. 36, 37.

<sup>5</sup> Pedretti C. *Leonardo. The machines*. Florence: Giunti, 1999, p. 90.



Galileo goes in the same way as Leonardo da Vinci to drawing of the machines. But Galileo on the contrary of Leonardo reduced such drawings to the geometrical models. For example, he used the inclined plane as the universal explanatory model for all machines. Galileo investigated in his *Mechanics* a nature of screw with help of the ideal model of the inclined plane as triangle (Fig. 3).

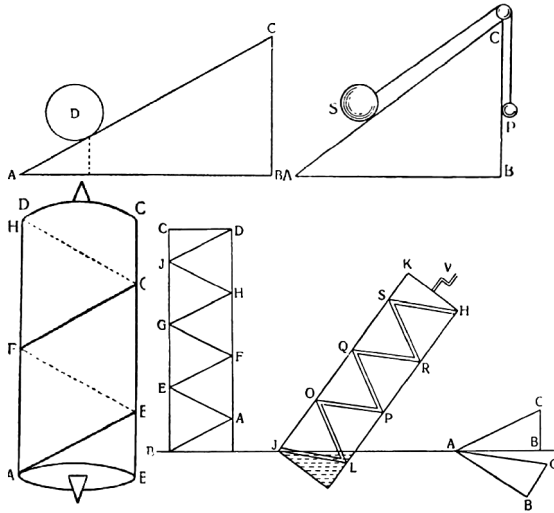

Fig. 3. Inclined plane as the universal explanatory model for all machines

With help of geometry Galileo can teach of the military engineers to use of the mathematical instruments. “In the workshop, Galileo achieved a quite systematic production of military and surveying compasses of different kinds. <...> In fact, the instruments produced and sold in Galileo’s household were only useful together with the knowledge of how to operate them. The transmission of this knowledge was, therefore, another essential activity, going on in Galileo’s household and intimately related to the workshop. Private lessons were Galileo’s way of transmitting this knowledge <...> the most significant difference that distinguishes Galileo’s curriculum concerns the long and detailed explanation of the uses of mathematical instruments like the

compass for military purposes”<sup>6</sup>. Therefore, Galileo demonstrated how to develop scientific knowledge so that it could be used for technical purposes. Galileo personified a new figure, the engineer-scientist. Galileo's works paved the way for the formation of engineering thinking and activity in practice as well as theory (Fig. 4).

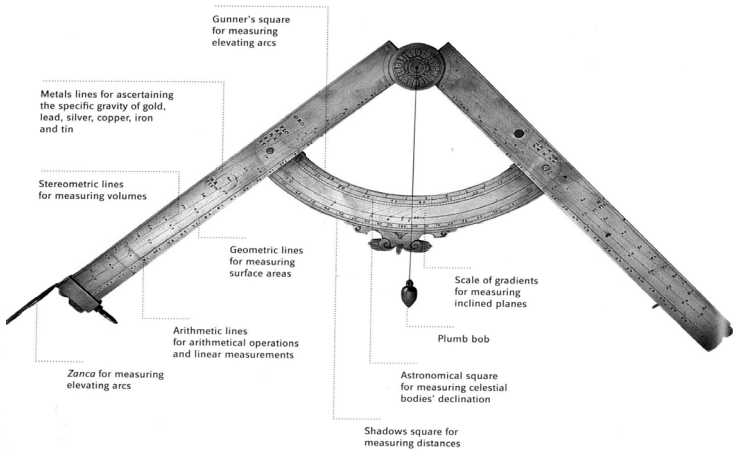

Fig. 4. The Military Compass as teaching mathematical instrument for the art of war<sup>7</sup>

Galileo not only related a geometrical scheme to physical reality, but also to the constructions of the different complex machines. The Galileo's geometric-kinematic theoretical schematic model of the machines was a beginning and precondition of the application of the natural scientific theory to the first special engineering science – the theory of the mechanisms and machines or kinematics. But it was Euclid geometry. In the next phase of the development of the theory of mechanisms (kinematics of machinery) as an engineering science instead of Euclid geometry was elaborated the descriptive geometry of Gaspard Monge. Theory of mechanisms encloses now the general classification of mechanisms and

<sup>6</sup> Valleriani M. A view of Galileo's Ricordi Autografi. Galileo practitioner in Padua, in: Montesinos J., Solis C., (eds.) *Largo campo di filosofare, Fundación Canaria Orotava de Historia de la Ciencia*, La Orotava, 2001. Pp. 285–288.

<sup>7</sup> *Museo Galileo. A Guide to the Teasures of the Collection*. Firenze, 2010, p. 44.

the description of the structure of different mechanisms with help of the kinematic geometry as consists from kinematic pairs, chains and gears to multiply of structural schemes of the new technical systems. But in the both cases the scientific engineering education is a decisive factor for the development of the theoretical basis for the codification and systematization of the practical technical knowledge. The specificity of the engineering theory is based on that its findings are used largely for constructing technical systems rather than explaining natural processes. The requisite condition of engineering theory productivity is the presence of practical methodological knowledge, i.e. engineering recommendations stemming from theoretical research, in its empirical basis.

The science of kinematics has its origins in the need to systematically analyze and design machines at the beginnings of the industrial age. For example, Robert Willis wrote in his “Principles of mechanism” that in the engineering science it is important to reduce the Constructive Mechanism (or Machine Design) as real technical system to the various combinations of Pure Mechanism (sometimes called Kinematics of Machinery) as ideal model of this system and “to investigate them upon geometrical principles alone”<sup>8</sup>. Fr. Reuleaux in his “Kinematics of Machinery” wrote that pure kinematics or kinematics geometry is “the study of geometric representation of motion” and that “the geometrical abstraction of machine” is “the soul of machine”<sup>9</sup>.

Galileo did more than just observe natural phenomena. He would first construct an idealized experimental situation, leaving aside the question of its technical feasibility (the situation itself, while not existing in nature, was, however, reproducible in principle). Then he would design an ingenious project of the technically feasible experimental situation, say a pendulum (a mass suspended from a string), where the gravity force was separated from the force applied to the solid. Based on this project, a real experiment could be devised and conducted. Galileo elaborated not only a new scientific methodology, but also a new philosophy of technology (Fig. 5). Galileo himself was not

---

<sup>8</sup> Willis R. *Principles of mechanism. Designed for the use of students in the universities, and for engineering students generally.* London: Longmans, Green, and Co., 1870, p. 4.

<sup>9</sup> Reuleaux Fr. *Kinematics of Machinery: Outlines of a Theory of Machines* (trans. by A.B.W. Kennedy). London, McMillan, 1876. Pp. 56, 85, 84.

engaged in the building and designing of machines. But he “oversaw their construction or evaluated them”. His new science was able to evaluate the possibility of “the enlargement of devices from the scale of a model up to real machine”<sup>10</sup>.

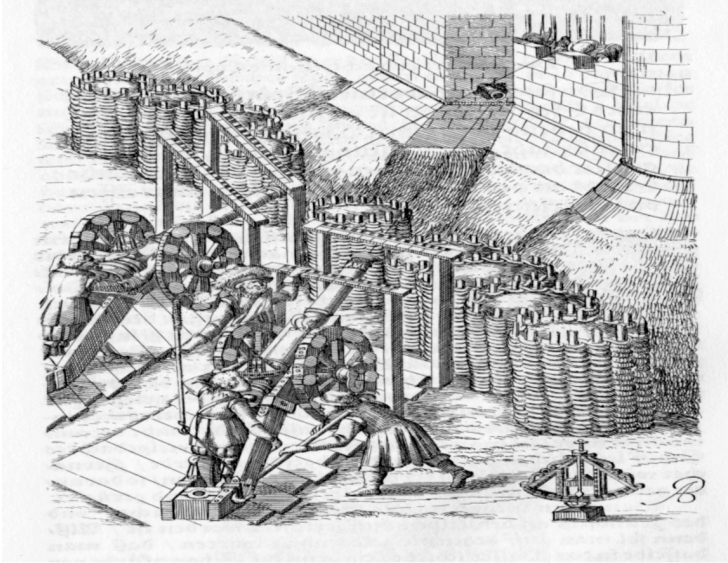

Fig. 5. Galileo’s philosophy of technology

Some likeness between fiction and scientific writing obscures a profound difference between the two styles of thinking, namely, the imaginative and scientific, which reached the acme of perfection in modern European culture during the Renaissance and modern time, respectively. Technical thought entering the engineering epoch was subject to influence by these two fundamental types of thinking, which was clearly manifest in Leonardo da Vinci's work, in which imaginative thinking is predominant. Leonardo, however, was not only an artist, but also a scientist and, perhaps, chiefly a Master-cum-Engineer. For this reason, Leonardo's type of thinking may more correctly be called

<sup>10</sup> Valleriani M. *Galileo Engineer*. Dordrecht, Heidelberg, London, New York, Springer, 2010, p. 113.

imaginative-scientific-technical and, hence, engineering. In modern time, the scientific, or, rather, scientific-technical type of thinking came to prevail in Europe. With Galileo, who was at the crossroads of these two crucial epochs in the evolution of modern human civilization, the style of thinking was still under the influence of Renaissance culture and might, therefore, be called scientific-imaginative, or, more exactly, scientific-imaginative-technical; it manifested itself in a specific form of treatment of a scientific text (as distinct from the strictly scientific texts written by Newton). These two main styles of thought were instrumental in transforming the technical thinking of craftsmen into the engineering-imaginative thinking of the Renaissance Masters-cum-Engineers, and its evolution into the modern engineering-scientific style of thinking.

Further development of new technology required a new science. Galileo Galilei was one of those who created this new science oriented to technical needs. He established the relation between scientific knowledge and the objects of practice. In Galileo's view, the real object exactly corresponds to the ideal object but is interpreted as a distortion of the ideal object's behaviour under the action of various factors, for instance friction. This made it possible for Galileo to modify the real object by acting on it in a practical way. As a result, its «negative» properties, which prevented it from being identical to the ideal object, became neutralized.

Before Galileo, scientific studies followed the ancient standard of obtaining knowledge about an object that was regarded as unchangeable. It occurred to nobody to change practically the real object of investigation (as it would then be considered to be another object). On the contrary, scientists strove to improve their theoretical model so that it would fully describe the behaviour of the real object. Therefore, Galileo created more than a model of experimental activity; he demonstrated how to develop scientific knowledge so that it could be used for technical purposes. That is why “technoscience” is an appropriate name for Galileo’s new science. Galileo realized in practice the purposeful application of scientific knowledge, which formed the methodological basis of engineering theory and practice. However, Galileo’s new method of technological reasoning and activity manifested itself mainly in the sphere of thought rather than in practical activity. There was really a new philosophy of technology.

## **LIFE SCIENCES IN BUILDING OF THE WORLD'S MODERN SCIENTIFIC PICTURE**

The world's scientific picture always acts as an adequate form of synthesis, harmonization of different approaches in the sphere of scientific knowledge of the concrete historical period. At the same time due to continuous development, enhancement and deepening of the scientific knowledge, it appears to be quite changeable and transformable. However, it does not mean that the world's scientific picture changes under influence of any scientific discovery. Nothing but the discoveries, that lead to fundamental transformations of not only the existing ontological ideas, but require (methodological, axiological, praxeological) changes of all other general basics of available philosophical knowledge; they lead to building of principally new vision of world's scientific picture.

Just the exact period is now being experienced by the current world's scientific picture under influence of all research complex of modern life sciences.

In the ontological aspect, in attempt of overcoming the gap in understanding of evolutional, organizational and functional approaches in research of the living, the modern biology has stated the difference in reality's ontological scheme presented in different branches of this science and in relation of biology to other sciences. This leads to forming of new world's picture, in which the synthesis appears to be not only as universal integrity, integration, but also as understanding of unlikeness of ontology models that are the bedrock of different branches of the modern science.

During the insignificant period of time (in terms of geology) the humanity has worked out and appropriated not many of fundamental ideas that had deeply influenced on its further development. One of such ideas is idea of evolution. Evolution ideas that appeared in high antiquity passed through all history of human civilization. All important personalias and concepts on this way, all arguments pro- and contra are reflected in tens, maybe even hundreds, earlier published books. However it is said significantly less about philosophic differences that were put in a base of this or other evolution concept, about meaning of these philosophical ideas in extrapolation of evolution theories of this sphere from biology to culture in the whole.

For many years Darwinism has become the paradigm of evolution ideas, characterizing the whole epoch in biology, in science in general and in culture. However, as the years go by there appeared the feeling of Darwinism's limitation defined by historical style of thinking only.

The synthesis of classical Darwinism and genetics, that actualized in the middle of the 20<sup>th</sup> century, has lead to consolidation of new popularized style of thinking in biology where ideas of evolution and organization were combined, at least at the molecular genetic level. This appeared to be the most important methodological achievement in the sphere of biological knowledge in the middle of the 20<sup>th</sup> century. Modern evolutionary synthesis (STE) theory basing on this thinking itself on its thinking appeared, for years it was the dominating evolution concept.

Meanwhile there is growth of understanding of STE limitation also. There are a lot of facts and ideas that could not be reflected within it. Number of various non-Darwinism theories, that furiously criticize STE, is growing. STE representatives are defending it with no less fury and arguments. And in this situation interesting and important consequence appears; it can be called as co-evolutionary idea, when in clash of two mutually exclusive positions none of them wins but a sort of synthesis of two of them is created. This can be regarded like manifestation of new style of thinking in biology that can be called as co-evolutionary one. Strengthening and extension of such type of thinking, as far as can be seen, may encourage new point of view on many conflictive moments of the modern biological knowledge. Among them there is a

problem of correspondence between Darwinism and Lamarckism, preformation and epigenesis, thycogenesis and nomogenesis, neutralism and punctualism, etc.

A lot of things that could not be explained earlier in the context of such ideology become understandable and obvious. For example, V. A. Krasilov in his ecosystem concept of evolution has defined two types of evolution – coherent and non-coherent ones. V. I. Nazarov<sup>1</sup>, characterizing the evolution theory of V. A. Krasilov, states in calm coherent period ecosystem's evolution happens slowly and gradually. The most significant characteristic in here is the stability which is natural for all climax communities that have completed ecological succession. Stability is provided by, first of all, dominating species with long life-cycles and little number of offspring. In such communities various mechanisms of competitiveness' weakening are developed, stabilization selection works in full manner, genetic diversity level of populations is high.

First of all, these are the ecosystems with constant conditions and full-year availability of food. They almost do not change throughout the duration of millions of years. Such type of evolution that exists in stable ecosystems, Krasilov called a coherent evolution. For its description the classical Darwinism, STE and other traditional theories were created.

But there is other type of evolution – non-coherent. The evolution of such type passes in unstable, damaged ecosystems, or, which is almost the same, in ecosystems that are in crisis conditions. Followers of this new model say that the most important evolution events (appearing of eucariotic cell, multicellularity, sexual reproduction, homoiothermy, placenta, intellect in other words all aromorphosis) happened in periods of crisis, in the phase of non-coherent evolution.

In the first place this negatively effected narrowly forms. In crisis conditions for sure those ones were the most adapted and most competitive species of the previous stage. They had very delicate adaptation to all complex of environment's conditions, with changes these adaptations are destroyed. There goes the process of extinction, not the survival, of the most adapted ones. With extinction of the dominants ecosystem's structure becomes more simple.

---

<sup>1</sup> Ref, V. I. Nazarov *Non-Darwin evolution*. Moscow, 2005. Pp. 442–444.



But the extinction of dominants has at least one major evolutionary consequence: with their vanishing free ecological niches appear. As well known, the nature abhors the vacuum, and species that earlier took modest place in ecosystem's economics rush in the got cleared niches. At that, it is important to note that changing of niche "owners" happens in non-violent way, not due to competitive struggle and displacement of one species by another ones, as it is stated by the theory of natural selection.

Species that occupied vacant niches have typically pioneer characteristics. They have few needs, they are relatively less specialized, they have short life cycle, heavy mortality (they are an object of massive unselected elimination), but it is compensated with high fertility. In conditions when, due to ecosystem's structure simplifying, competition (between species) has come down and intensity of stabilizing selection has decreased, the pioneer species are able to survive just thanking to their high reproductive potency.

It would seem, that crisis periods and phases of non-coherent evolution are characterized only by negative criteria: instead of survival of the most adapted ones there happens their extinction. Instead of growth of life duration it becomes shorter and there is high mortality of pioneer species. Production of entropy grows. These are all the signs of biology regress.

However, just in these periods the fundament of future progress is put. By reason of weakening of stabilized selection the conditions for genetic search and heavy increase of range of mutation (including appearing of the hidden reserve) are created. When competition slows down, wild life can afford evolutionary experimentation.

These are principally new statements that characterize understanding of the world's modern scientific picture, project methodology task of exploring of ontology schemes of reality presented in various sciences, reflexive work of their understanding, clarification of their mutual relation, their complementarity. Such work leads to forming of principally new methodological constructs of understanding of reality. In particular, the developing at the moment biology methodological construct of coupling of organization and evolution of material systems that got name of co-evolutionary construct, give new prospects for synthesis of natural and humanitarian sciences, overcoming of naturalism's, so-

ciologism's and historicism's limitations, taken apart from each other. This methodological approach to forming of the world's modern scientific picture encourages union of alternative strategies (elementarism and systemic, evolutionism and structuralism).

The synthesis of evolutionary and organizational approaches, consolidation of new methodological regulative principle (the principle of co-evolution) leads to forming of new style of thinking in biology, where ideas of organization and evolution act not in parallel, they are not mutually exclusive, but both of them are inseparable holistic mutually presuming both parts of continuum. In this logic evolution is not regarded without or independently from organization, and on the hand idea about organization is poor without evolution idea.

So, the co-evolutionary thinking that was understood in biology, spreads in the culture also. It enables to overcome a gap between evolutionary approach to nature and human, to identify ways of synthesis between evolutionism in nature and in social cultural sphere. Co-evolutionary thinking leads to understanding of synchronism between ethnical national and social cultural commonness with nature geographical conditions of environment, to understanding of mutual ways and bound evolution of nature and human, biosphere and noosphere, nature, civilization and culture<sup>2</sup>.

All these ontological and methodological intentions of the new forming world's scientific picture under influence of discoveries in biology are smoothly connected to axiological and praxeological aspects of the modern vision of reality. This is an opportunity to understand new structure of the world in the context of constructive practice of transformation of living, new understanding of reality in the light of coenotic approaches in connection to bio, geo and anthropocenosis, to the problem of new understanding of world under conditions of development of bio and eco ethics, bio and eco policies, etc.

Therefore, it can be said that the currently forming world's modern scientific picture, that appears under influence of biological ideas, is not only the synthetic systemized and integral idea about the world at the present stage of scientific learning in its logical form of reflection of reality, but also it is the result of synthesis of all fundamental parts of philosophical knowledge of our historical period including the ontological, methodological, axiological and praxeological aspects.

---

<sup>2</sup> Karpinskaya, R.S., Liseyev, I.K., Ogurtsov, A.P. *Philosophy of nature: the co-evolutionary strategy*. Interpraks. Moscow, 1995 [in Russian].

*E. Mamchur*

## **METAPHYSICS AND THE PROGRESS OF SCIENCE**

As Richard Rorty<sup>1</sup> noted in his review of one of the books by Ian Hacking<sup>2</sup>, there are currently three views upon the nature of scientific theories. The advocates of the first one believe that science is capable of revealing the inner structure of researched objects. These objects are not created or constructed by scientists; they are discovered and investigated by them. This view is supported by the majority of scientists and philosophers-realists.

Another view is that science is incapable of revealing the inner structure of things. Moreover, it denies this inner structure, especially if one supposes that it has a-historical character, since the researched objects are constructed by scientists themselves. (Rorty characterizes this view as postmodernism).

Social science has been well aware of such characteristic of the researched objects long ago. However, the postmodern philosophers do not differentiate between the objects of natural and social sciences, since they both are considered social constructs. For example, “quarks” and “genes” are social constructs, the same as “disease”, “psychical norms” and “a-social behavior”. For this matter, the advocate of the above hypothesis Andrew Pickering says that the quark

---

<sup>1</sup> Rorty, R. Phony Science Wars, in: *The Atlantic Monthly*, November 1999, Vol. 284, No. 5. Pp. 120–122.

<sup>2</sup> Hacking, I. *The Social Construction of What?* Harvard University Press, 1999.

idea has not been predetermined by nature. It has been constructed by people and is determined within the framework of a particular culture<sup>3</sup>.

According to the supporters of the second view, theoretical objects of natural science are being constructed by scientists as a means, as instruments to successfully develop scientific research and predict new facts.

There is the third point of view. It belongs to Ian Hacking. Not being postmodernist Hacking, however, assumes that modern science that has deciphered the DNA code or invented computer could have achieved the same in different ways if it had launched as ontological other theoretical entities. His point, therefore, differs from the view of more consecutive physicists-realists. It is possible in this connection to quote the words of the Nobel Prize winner in physics Sheldon Glashow: "There exist eternal, objective, a-historical, socially neutral and universal truths. The collection of these truths is what we call physical science"<sup>4</sup>.

However, the fact of co-existing empirically equivalent theories varying one from another in theoretical content is well-known to methodologists of science. How do we know which one of the existing theories is true? Do we have to search for a correct one? Instrumentalists believe that we should not assume that scientific notions have references in reality. In the meantime, the realists, who assume that the ontological entities of the most successful theory do exist in reality, think differently and look for the right alternative among the competing theories.

The main obstacle in accepting the viewpoint of realists for Hacking and some serious postmodernists is the difficulty to compare the real reality with our description of it. This is the reason why the well-known cosmologist Steven Hocking supports instrumentalism: "The realism of theories is not a quality to check out with a litmus test. All I need is a theory to predict the results of measurements." Thus, since there is still no answer as to what are the criteria of reality, Hacking makes the conclusion that the problem of adequate interpretation of the nature of scientific cognition is not solved yet.

---

<sup>3</sup> Pickering, A. *Constructing Quarks: A Sociological History of Particle Physics*. Edinburgh, 1983.

<sup>4</sup> Glashow, Sh. The Death of Science!?! in: *The End of Science? Attack and Defence*, Lanham, University Press of America, 1992, p. 28.

Now, let us go back to Rorty's review. His main question is whether or not anything would change in the work of scientists if the instrumentalism of postmodernists wins over in the argument with the philosophers of science. The question sounds ironical, and the answer he gives is negative. Scientists, says Rorty, do not care much for the philosophical aspects of the nature of scientific cognition. They do not care as to who is right – realists or postmodernists. They might discuss it some time at lunch, but not more. In their labs they just keep working regardless of what philosophical standpoint will eventually win, though deep in soul they are realists as a rule.

It seems, however, that Rorty is not right. First of all, not all scientists are the same. According to Einstein, there are “craftsmen” and there are “truth finders” in science. Secondly, it is by no means pointless for the development of science to find the right strategy. Instrumentalism is not productive in the long term, though it might be useful at certain time periods of science development. In any case, it will lead to stagnation anyway, as it happened to the modern physics of particles. The well known theoretical physicist Lee Smolin argues that the “explosive growth” of physics, which lasted more than two hundred years, has stalled in recent decades, and he sees the reason for it in the present style of managing science.

Modern physics is dominated by the ideology and strategy of instrumentalism. They have dominated particle physics since 1940s. Instrumentalist strategy is pragmatic and encourages virtuoso calculations, Smolin says, but it is very different from the way science was executed by A. Einstein, N. Bohr, W. Heisenberg, E. Schroedinger, and other revolutionaries of the early 20<sup>th</sup> century. Their work arose out of a deep reflection on the most basic questions of being<sup>5</sup>.

Metaphysics occupies the most prominent place in philosophy. The notion of metaphysics is rather complicated by nature. With no consensus about its content available, let us take as a basis the definition given by M. Heidegger, who pondered over the metaphysics more than any other philosopher in 20<sup>th</sup> century. Defining this concept he wrote that whereas

---

<sup>5</sup> Smolin, L. *The Trouble with Physics: the Rise of String Theory, the Fall of Science and What Comes Next*. Houghton Mifflin Company, 2006.

science is the knowledge of what exists, “Metaphysics is a questioning of super existing, beyond it, so that after this questioning we get the existing to understand it as such and as a whole”<sup>6</sup>.

Metaphysics plays an heuristic role in scientific cognition. However metaphysical premises as such can not reliably guide scientists in their search for true theories because they are subject to constant revision. It seems that the heuristic role in scientific knowledge is performed not by specific metaphysical principles or their content, but by the very existence of the realm of “super existing”. Operating in this sphere allows the scientist to raise the question about the world as a whole, which he cannot ask staying within the realm of the existing only. The heuristics of metaphysics consists in stimulating scientist to put such questions. The answers vary, and many of them have to be given up as scientific knowledge advances to a new level of research. Science continues to evolve and move forward in so far as the desire to pose metaphysical problems and seek answers to them is retained and constantly reproduces itself. It seems that scientific knowledge is a sphere where something akin to the nietzschean “eternal return” is taking place. In our case, it is a return to metaphysics.

Oblivion of metaphysics “revenge” science, dooming it to stagnation. By ignoring the sphere of “super existing” scientists loose the most important source of intelligibility of the very existing. Notwithstanding the genius of R. Feynman, F. Dyson, and S. Weinberg who developed the standard model of particle physics, these scholars did not give much thought to metaphysical issues. On the one hand, notes Smolin, this allowed them for almost thirty years to develop successfully various applications of the standard model, without distracting themselves with discussions of fundamental problems of science. On the other hand, this has eventually led to slowing down of physics development.

Smolin describes the transition to a pragmatic style of thinking and instrumentalist methodology as “a triumph of craftsmen over prophets”<sup>7</sup>. Unflattering words to many scientists working in particle physics. But in this case Smolin simply uses Einstein’s terminology, who dis-

---

<sup>6</sup> Haidegger, M. *Nauka i osmysleniye*, in: *Vremia i bytiye*. Moscow, 1993, S. 250 [in Pussian].

<sup>7</sup> Smolin, L. *The Trouble with Physics: the Rise of String Theory, the Fall of Science and What Comes Next*. Houghton Mifflin Company, 2006.

tinguished between two types of scientists – “ordinary workmen” and “genuine seekers of truth”. The first, Einstein said, see many trees, but never see the forest. By focusing on details, they do not see the whole. This ability is granted to those willing and able to come out into the sphere of metaphysics.

We do not hold a very common belief that modern science is in a crisis. The situation in modern science is almost the same as in the time of Heidegger, when he says that science as such is not in a crisis, and “there only are difficulties encountered in the interpretation of the basic concepts of some disciplines”<sup>8</sup>. Nevertheless, slower growth is observed. To overcome it we have to give up the ideology of instrumentalism and the penchant for applied applications and to return to the strategies targeted at formulation of fundamental metaphysical problems. Smolin is right when he says that physics today is more than ever in need of “prophets”.

---

<sup>8</sup> Heidegger, M. *Nauka i osmysleniye*, in: *Vremia i bytiye*. Moscow, 1993, S. 252 [in Pussian].

### III. ETHICS

R. Apressyan

#### TWO PARADIGMS IN PHILOSOPHY OF LOVE

##### 1

In 1840 Arthur Schopenhauer certified with certainty that philosophy had lost love as a central philosophical issue and thus had lost something crucial in itself. At the time of Schopenhauer this observation could be appreciated as plausible resume of one of the tendencies in Modern philosophy development since Descartes.

It is true that the love discourse was marginalized in Modern philosophy of the 17<sup>th</sup>–18<sup>th</sup> centuries. I would explain that tendency by two factors. Firstly, Descartes and Spinoza, roughly speaking, almost reduced love to passions which they considered in opposition to reason. Secondly, debasement of love as philosophical subject matter was determined by migration of ideas, owing to which the normative content elaborated within the amour-discourse and accumulated in the concepts of love and friendship, drifted to different philosophical contexts, mainly, to moral philosophy. I mean that the normative content of Modern concept of morality was largely based on the heritage of the ideas of eros, philia, agape<sup>1</sup>. I certainly realize that the Modern concept of morality had among its sources the concepts of obligation, natural law, and virtue, but the normative component was mainly determined by the ideas of love.

---

<sup>1</sup> Apressyan, R. From “friendship” and “love” – to “morality”: on a certain subject in the history of ideas, in: *Ethical Thinking* / Ed. by A. A. Guseynov. Moscow, IPH RAS, 2000, p. 182–194 <<http://iph.ras.ru/uplfile/root/biblio/em/em1/11.pdf>> [in Russian].



We can consider Schopenhauer's impression also as a reflection (or anticipation) of some intellectual aspirations due to which love was returned to philosophy and broader theoretical discourse, though differently conceptualized: it was no more interpreted as some 'universalia' of human existence, but rather as one among other facts or conditions of human life. In the second half of the 19<sup>th</sup> century and the beginning of the 20<sup>th</sup> century communicative, emotional and sexual components of love were brought to the forefront and theories of love were more and more saturated with positive and scientifically associated knowledge.

To my mind, Schopenhauer himself played a significant role in this turn. If we look at section 44 of his most well-known work, *The World as Will and Representation*, we will see that love, according to Schopenhauer, is an illusion, beyond which he distinguished just the will for reproduction. Schopenhauer's image of love is physical and materialistic rather than spiritual and deified. Beyond Schopenhauer's words of reproduction one easily ascertains sexuality as love's dominant attribute. That is why he sharply discriminated love and friendship; he associated only the latter with affinity of souls, unanimity, joy of intercommunication and other 'sublime aspirations'.

Stendahl's essay *On Love* was released three years later Schopenhauer's *The World as Will and Representation*. I am not sure, whether Stendahl read Schopenhauer or not. But in his picture of love, which was certainly romantic, Stendahl represented the same tendency in the development of love discourse, namely the tendency towards de-deification of love, showing love as materially-based phenomena, understood as an aspect of human relations.

Of course, if we take the conceptions of love by Søren Kierkegaard, Ludwig Feuerbach or Russian religious philosophers, Vladimir Soloviev first of all, but not him only, and by later philosophers of the phenomenological school – Max Scheler and Dietrich von Hildebrand (our senior contemporary), we will see that the turn of reflective attention to communicative, sensual, and sexual components of love was not overwhelming. Nevertheless it was more than noticeable, it was remarkable.

Perhaps the crucial point in evolution of the love discourse was staked by Sigmund Freud's well known psychological discoveries and their philosophical interpretation. Actually Freud contributed no construc-

tive ideas regarding the essence of love, but his anthropological doctrine in general and his theory of sexuality in particular had a powerful influence on understanding the source of love and its psychic nature. Although many representative of later intellectual movements, like phenomenological anthropology, structuralism, or post-structuralism and even post-Freudian psychoanalysis were rather skeptical against Freudian interpretations of eros, desire, communication, personal self-realization, etc., it was Freud and Freudism, starting from which we can speak about cardinal turn from conceptions of love oriented to spiritual excellence of the ideal person in love to interpretations of love mainly oriented to live individuals and communication.

So, I distinguish two paradigms in philosophy of love (not in the phenomenon of love): perfection-oriented paradigm and communication-oriented paradigm.

## 2

My observation may leave an impression that the old, or classical theories of love were perfection-oriented and postclassical theories of love are communication-oriented. This impression is only partly true. As a matter of fact many classical theories of love were interested in analyzing human relations, too.

If we compare, for example, Plato's philosophy of love-eros and Aristotle's philosophy of love-*philia*, we would rather distinguish them at first thought as representing the perfection-oriented paradigm (Plato, of course) and the communication-oriented paradigm (certainly, Aristotle). But strictly speaking even in Plato's *Symposium* one can trace the elements of both paradigms. It was Socrates in *Symposium*, who easily sacrificed the real human relations with particular embodiments of the beauty in characters and bodies at the altar of his thought. Other interlocutors in that famous feast-discussion were not near ascetics and felt no problem in distinguishing the meaning of love-eros in the very conjunction of individuals, in communication, and mutual care. Aristophanes presented reunifying function of eros as almost the dominant one. It is him, who gave in the dialogue one of two principle definitions

of eros: “the desire and pursuit of the whole is called love”<sup>2</sup>, everyone discovers in love his own unique another Self, in unification with which one acquires harmony. Nevertheless, the true pathos of love-eros – is in determination to excellence, what is completely proved by concluding Alcibiades’ speech. And the high point of the dialogue is Socrates’ speech, in which he displays the hierarchy of the beauties or the Ladder of Beauty as the way to the Eternal Beauty and the Supreme Good. Eros appears to be the fundamental cognitive and creative power. In love to the other the person realizes himself, renovates himself, and becomes immortal. The attitude towards the Supreme determines the Self’s attitude towards the Other and gives sense to it.

Aristotle’ doctrine of love-*philia* looks like communication-oriented one. But if we look at it attentively, we’ll see that it is at least not exhausted by communicative features. Aristotle’s doctrine of love-*philia* is blend in ethics, which starts with a discourse on the supreme good, followed by discourse on the good in man (i.e. virtues) and the good in human interrelations (and this is his doctrine of *philia*) and concluded by a doctrine of happiness as the good realized in the individual or the way how the individual becomes communicated with the Supreme Good, i.e. perfect. Unlike Plato who considered love-eros as unequal relation, Aristotle understood love-*philia* as the relation, which in its sublime embodiments assumes relations of virtuous and more than that, wise people. In other words, to acquire true friendship one should be excellent – excellent in virtue and reasoning.

Relative difference between perfection-oriented and communication-oriented paradigms as it evident in Plato and Aristotle is left behind by the Christian ideal of love-*agape*, according to which love to one’s neighbor is mediated by love to God and the love to God cannot be performed otherwise than in love to one’s neighbor. In spite of synthesis gained in Christian doctrine of love-*agape*, different theories of love in the history of ideas are drawn to one or another paradigm rendering either Platonic, or Aristotelian vision of love.

---

<sup>2</sup> Plato. Symposium, 193a, in: *Plato. Collected edition*, in 4 volumes. Vol. 1. Moscow, Thinking, 1990, p. 121 [in Russian].

So, we find both, perfection-oriented and communication-oriented paradigms in the classical thought. However, no matter, what paradigm was dominated in this or that doctrine, they all are characterized by two features. Firstly, at descriptive level love is considered as separated of eroticism and sexuality. Secondly, at normative level classical theories of love contain a kind of ethic. So far true love is interpreted as a state of excellence, so far there are images of true and false, or heavenly and earthly love, a theory of love become an ethical theory.

The classical theories of love, which belong to perfection-oriented paradigm, are sufficient enough in setting up an image of ideal love, often specified in particular deserving and praiseworthy features. On the basis of such ideal image they provide criticism, sometimes quite reasonable, of real love practices. At the same time, perfection-oriented theories of love faces difficulties to explain the variety of mental, communicative, behavioral relations in love; they stumbles over experience of live loving relations of real men and women and much more over relations of shrinking love, of cracks and faults in love. Perfection-oriented theories of love are always strived towards ‘pure’ concept of love not only in theoretical, but also normative sense of the word. In the most extreme form this comes to light, when such theories approach human sexuality. Love in such doctrines is de-sexualized. I do not mean that classical philosophy of love prefers not to deal with sexuality, does not recognize sexuality or refuses it. But in perfection-oriented theories sexuality is separated from love and is considered as a real thread to love in its true that is sublime embodiments.

The situation is different in postclassical theories of love. What we find here is the following. Firstly, love (speaking about sensual love) is intentionally presented in association with the variety of communicative practices and experiences, including such significant part of human relations as sexuality. Secondly, the doctrines of love are developed in descriptive rather than normative modalities.

Two notes should be added to what have been said. The border between classical and postclassical doctrines is determined by methodological differences rather than chronological attribution. In Modern philoso-

phy, I mean classical philosophy of 17<sup>th</sup> – early 19<sup>th</sup> centuries, one can trace tendencies, which would be revealed in full scale in postclassical philosophy. Likely with appearance of postclassical philosophy some features of classical philosophy have survived. The same we can discover in the philosophy of love: some elements first detected and identified in new theories retrospectively could be distinguished in classical theories and some typical features of the latter – in chronologically new ones. A very interesting example in this regard gives a book *The Metaphysics of Love*, by Dietrich von Hildebrand, a prominent Catholic philosopher, who passed away in 1977 and who proposed one of the most elaborated teaching of love, which is according to the proposed classification should be qualified as a theory of completely classical perfection-oriented type.

Without doubt, communication-oriented paradigm prevailed in current amouology in the sense that it edged out the perfection-oriented amouology. New love theoreticians have recognized specific nature of love in erotic fullness of emotions and human relations, which should not be suppressed by normative ideal. This certainly does not mean that any ethical ideal should be thrown overboard.

To make specified and substantial conclusions regarding contemporary theories of love one should analyse some experiences of analysis of romantic love and its alternatives, real and potential, which up to change and changing the existing erotic and love ethos. Various interesting traits of modern theories of love have been revealed in rethinking of the ideal of romantic love. I would point to the works by the American psychologist Robert Johnson, British sociologist Anthony Giddens, and American sociologist Ann Swidler as the most interesting examples of this kind.

## **TOWARDS A CORE UNDERSTANDING OF MORALITY**

Morality is heterogeneous and this is the main reason why it is difficult to give its comprehensive conceptualization and even to give its complete description.

As we can see in current literature, there are various approaches to understanding and representation morality. It can be interpreted as: a) norms and values, b) the person's capability to self-sustained judgement and action, c) a means to harmonize human relations, d) a measure of humanness in social relations and public establishment, e) a way of individual self-realization or self-determination as personality, perfect, unique, and special personality, f) an instrument of public discipline, g) a means to compensate at individual level public disciplinary efforts, h) etc.

The list is certainly not full. Representing different aspects of morality these characteristics of morality are quite realistic. However it would be probably difficult if not impossible to reconcile these characteristics in some integrated definition of morality. For instance, how to reconcile at the level of core definition the understandings of morality as a means of normative regulation of human behavior and human relations, on the one hand, and as a mode of subjectivity formation, on the other hand. The problem is how to provide a comprehensive description of morality taking into account its heterogenic and multi-facet nature?

For time-saving I am not going to discuss the methodological aspects of this problem, but rather present my interpretation of morality.

The sociocultural meaning of morality is in coordination of partial interests for the sake of individual and public good. Morality is aimed to provide various means (value, normative, communicative, social, intellectual) to de-escalate and resolve interpersonal conflicts, to promote cooperation, to provide the possessors of partial interest with different reasons not to prevent each other and, better, to promote each other in the pursuit of the good and to contribute to public good, ideally, ‘just’ part-way through actualizing one’s own interests and pursuing one’s aims.

I consider morality mainly as a system of values. In this sense my approach is certainly an anti-imperativist one. It would be wrong to reduce morality to the good or to the pursuit of the good as such. To implement the value of the good one has to undertake particular actions (course of behavior at individual level or a policy on public level), which are appreciated for their furthering efforts for the sake of the good (individual good, good of others, or public good) and which, hence, are recognized as valuable.

Actions have positive value if they do not hurt others, an actor by an action recognizes others, and promotes others in their legitimate aspirations. Such actions are ethically worth-while, i.e. they are desirable, useful, significant, and productive. The basic moral values are the values of *non-hurting*, *recognition*, *solidarity*, and *care*. Historically the ideas of values emerged as a result of generalization and rationalization of the actions of such kind.

These values are manifested in ‘abstractive’ and ‘ideal’ form. But they are also represented in imperative modality. So, they are not only articulated, but also given for practical exercising through attitudes and actions. In other words, they are given as requirements: *do not hurt others* (or *do not cause harm*), *recognize others*, *help others*, *take care of others*. In communicative experience these requirements can be presented as expectations, recommendations, insistences, reciprocally expressed by moral agents. At a communitarian or social level they are set up in a form of norms, often integrated into codes.

By the very fact of requirement these values presume a certain type of personality – capable to perceive, understand and exercise them, what means that s/he possesses particular intellectual, communicative, and

behavioral abilities. Virtues are the character qualities and abilities owing to which a person becomes a moral agent, i.e. enable to reflect moral values and to be sensitive to their imperative force. The value of *personal excellence* sets up the direction of personal moral development. The values of virtue and excellence are also manifested in corresponding requirements: to be virtuous, to strain after excellence.

The above indicated values are at the basis morality framework, which reflects the main functions of morality – I mean, communication-orienting and excellence-orienting functions. The former one promotes positive interaction between moral agents. The latter one promotes individual ascend moral excellence. In their advanced form these values are expressed in the ethic of love with mercy and care as its leading principles in treating one's neighbor. Causing harm is the direct opposite to love; recognition and solidarity/help are the forms of advancing moral attitude towards the Other from non-hurting to care and love.

Putting morality in direct relation to definite value content I am able to distinguish its manifestations beyond acknowledged oughtness, intentional and conscientious exercise of prescribed values. Though socializing individual first perceives morality in a form of behavioral patterns and rules, his/her perception is based on initial experience of this value content associated mainly his/her own individual good, in other words, ego-centrally (causing no harm to me, recognition of me, solidarity with me, taking care of me). This means that potential moral content is usually familiarized as non-moral, as values regarding oneself rather than others.

Morality is presented to moral agents as *requirements* in broad sense of the term, including: a) *principles*, b) *commitments* determined by conventions, and c) expectations expressed by particular individuals in particular circumstances following the values they share and the communicative and social experience given in public/communal habits and traditions. Morality is also implemented in actions anyhow related to individual and public good. An action has moral meaning even in case when it has been performed without agent's personal intention regarding moral values, hence in case of minimal or even zero moral subjectivity of the action. A person may be motivated to perform moral values and exercise moral requirement by imitation, formal or conscience



obedience, compassion, or tradition. The moral character of an action is certified by its recipients, either real, i.e. action's subjects, or 'ideal', i.e. third-party observers of the action and/or its consequences.

A mode of motivation is not so specific for morality, though it signifies what kind of moral character a person has. Intentionality is a significant aspect of moral behavior. So far morality relies on personal responsibility in action, it is important indeed, who, how, following which motives and for what reasons makes and implements decisions. These features testify the moral quality of an action and an agent, namely, a level of awareness in action, an agent's independence and autonomy, a degree of rationality in intentions, etc. However, these features are not sufficient to qualify an action as a moral one, because either intentionality, or rationality, or autonomy may characterize different in their subject matter actions, unrelated to the good of individuals and society.

Moral values are perceived as requirements, whose imperative power has different sources: culture, conventions, and interpersonal communication.

Culture is a source of moral imperativity in the sense that it accumulates and translates moral values through broad variety of general meanings, patterns, texts, traditions, etc. Moral requirements are engraved on 'tablets' of some kind only symbolically. Mostly they are presented in some collective memory and dispersed among different loci of culture rather than given in codes, though in codes as well. In this respect culture is the 'background' source of moral imperativity. This source is objective and impersonal and thus naturally considered as unconditional, self-sufficient and maybe transcendental. The religious mind considers this source of morality as supra-natural, or divine. We can interpret it as really transcendental in a sense that the culture in its universal meaning is transcendent to social reality, to here-and-now status quo, to social conditions and particular circumstances. Imperative power of general cultural ideas is potential. To become powerful and actually prescriptive for a moral agent they need to be recognized by her/him; otherwise they are only neutral artifacts like the units of archive storage. Cultural ideas become actually significant and enable functioning as prescriptions owing to different forms of education, systematic or spontaneous and inclusion of an individual to various communicative practices, as well as understanding and familiarizing cultural experience.

Various in nature conventions are another source of moral imperativity. Conventions determine obligations and commitments. They can be accepted unilaterally and even be not articulated, but only assumed by one's statement of one's position. By only declaration of her/his position a person becomes committed to what he/she has declared. Some obligations are determined by mere respect to other's status, without any agreement or oath. An individual's attitude towards a society or a leader (authority) is fixed in particular obligations, which can be accepted by default or may be anyhow articulated.

One more source of moral imperativity is live interpersonal relations. The person becomes morally responsible by the very presence of another person and hence the necessity of practical respond to the other person. S/he is compelled to certain actions by a particular communicative situation, which challenges her/him to act accordingly.

A question "What should I do" has a number of facets. What should I do in this particular situation towards this particular person to meet my obligations and to implement general moral standards? And then: how to apply the supreme moral standards to the given particular situation? Moral decision reflects not only the general moral requirements and the obligations determined by agreements, but also the expectations of the particular other, whom one's meets in a given situation. A respond to other's expectations should not be confused with connivance at other's caprices. And moral action is evaluated according to all these factors: how it relates to the general moral values and particular obligations and how much adequately to the given situation they have been executed.

## WHAT MORALITY IS ABOUT

When we put the question, what morality is about, we imply different things. We mean, for example, the definition of morality or criteria of the moral. Bernard Williams in his paper “What is Morality about?” approaches the question as if it were about the fundamental features of morality which distinguish it from any other phenomena. As Williams himself sees the question: it is about “how ‘the moral’ is to be delimited”<sup>1</sup>.

I address the question what morality is about, in a slightly different way. My approach to it is influenced to a large extent by a discussion on Kant’s essay “On the Supposed Right to Lie from Altruistic Motives” that took place in philosophical literature, and such moral philosophers as Alasdair MacIntyre<sup>2</sup>, Christine Korsgaard<sup>3</sup> and some others have been involved in it. A rather heated discussion on Kant’s essay was also held in our department few years ago.

---

<sup>1</sup> Vid.: Williams, B. ‘What is Morality about?’ in: *Morality. An Introduction to Ethics*. Cambridge: Cambridge University Press, 1993, p. 73.

<sup>2</sup> Vid.: MacIntyre, A. ‘Truthfulness, Lies, and Moral Philosophers: What Can We Learn from Mill and Kant?’ in: *Ethics and Politics: Selected Essays*. Vol. 2. Cambridge: Cambridge University Press, 2006. Pp. 101–21.

<sup>3</sup> Vid.: Korsgaard, Chr. ‘The Right to Lie: Kant on Dealing with Evil’, in: *Creating the Kingdom of Ends*. Cambridge: Cambridge University Press, 2000. Pp. 133–58.

Some disputants take pro-Kantian position, the others anti-Kantian one. Both sides adopt a tough stance, and that is determined rather by disputants' inherently incompatible ideas about morality and its subject-matter, than by their belief concerning permissibility or impermissibility of lies in some critical situations.

For Kantians, morality is about purely autonomous moral agent (that is independent in his judgments and decisions from other people, specific circumstances and from all other kinds of determination – cultural, social, communicative, psychological, etc.). Morality is also about the moral agent's attitude to absolute, presented by some necessary, unconditional and universal principles and norms which include the prohibition on lie. It is the attitude to absolute moral principles and norms (and not to other persons) that constitutes the main moral attitude within this framework. That does not necessarily presuppose the neglect of the particular *Other* or *Others*. What's presupposed here is that true attitude to particular *Other* or *Others* may be established only by the obedience to the absolute principals. The recognition of the absolute moral principles and norms and of necessity to conform to them is the only thing that can bring human beings together on real moral grounds. As Christine Korsgaard puts it: "Kant's rigorism about lying is not the result of a misplaced love of consistency or legalistic thinking. Instead, it comes from an attractive ideal of human relations which is the basis of his ethical system".<sup>4</sup> This attractive ideal is presented in Kant's moral philosophy in the concept of a Kingdom of Ends.

For anti-Kantians, morality is essentially about a moral agent who by his entire being is integrated into the real world. This is the world of interpersonal relationships, sociality, culture and even nature. It is this world that substantially forms moral agent's identity. Morality within this framework is also about such moral agent's attitude to particular *Other* or *Others* and about interpersonal relationships as well. The attitude to the *Other* (not to the principles and norms) is considered to be the main moral attitude. All this doesn't mean that the given approach neglects principles and norms or their vital importance in the moral domain. It means only that it is wrong to reduce all morality to principles and norms.

---

<sup>4</sup> Korsgaard, Chr. Korsgaard, Chr. 'The Right to Lie: Kant on Dealing with Evil', p. 135.

So, in my presentation the question *What morality is about* concerns the subject-matter of morality. To put it roughly, the question is: whether morality is about a moral agent's attitude to the necessary and unconditional principles and norms or, instead, it is about a moral agent's attitude to the particular Other (Others) and about interpersonal relationships as well. This question also addresses the problem of moral responsibility. What is the subject of moral responsibility: conformity to principles and norms or the *Other (Others)* with whom we are in relationships of any kind and their well-being as well?

In this presentation I want to give some reasons to show why the second perspective appears to me to be more sound.

In the above mentioned paper Christin Korsgaard wrote: "One of the great difficulties with Kant's moral philosophy is that it seems to imply that our moral obligations leave us powerless in the face of evil. Kant's theory sets a high ideal of conduct and tells us to live up to that ideal regardless of what other persons do. The results may be very bad. But Kant says that the law "remains in full force, because it commands categorically".<sup>5</sup> This is a very important point about the morality of absolute principles and norms that makes it open to criticism. And this concept of morality has no internal resources to respond to it. For Kant the only way to resist evil is to follow the moral law. In other words, for resistance to evil it is enough to maintain one's own moral perfection. But even if we do agree with that we can't but recognize that in a number of situations it is impossible to follow the moral law irreproachably and thus to maintain one's moral purity.

This is especially true about the situations of a forced choice of the lesser of two evils. Here unconditional adherence to principle or norm, which can be recognized fundamental to morality, defining the very meaning of it as well as the status of a moral agent, turns into insoluble contradictions. The immaculate behaviour of a moral agent in view of this principle or norm is inevitably compromised, since under given circumstances it is impossible to follow it "cleanly." And it is Kant's essay "On Supposed Right to Lie from Altruistic Motives" that gives us reasons for such a conclusion.

---

<sup>5</sup> Korsgaard, Chr. Korsgaard, Chr. 'The Right to Lie: Kant on Dealing with Evil', p. 133.

Kant tries to demonstrate that in any situation, even the most dramatic one, violation of the fundamental moral prohibition is unacceptable and in no way can be justified. However, further analysis of this scenario reveals something else – namely, that fulfilling a moral obligation regarding one person is only possible at the expense of breaking it regarding another. According to Kant’s example, by giving a true answer to an obvious murderer about the location of a friend whom he obviously intends to kill, the owner of the house breaks the promise given to his friend, who was given shelter in his house and therefore also a promise of protection. Keeping one’s promises is regarded by Kant as another form of the obligation of truthfulness. The minimal price that the house owner has to pay for not breaking the norm of not lying in his dealings with the villain is breaking the same norm as far as his friend is concerned. Similarly, by keeping the promise given to his friend, the house owner fails to meet the obligation of truthfulness regarding the villain. In any case, the fundamental **prohibition of lying is inevitably broken. Even if we consider this prohibition fundamental in the sense that it stands above all the other moral requirements and has unconditional priority, being the very condition of morality, a moral agent who is not under the necessity to having to choose between fulfilling this obligation and other ones (in our case, the obligation to protect an actual person from harm) cannot avoid having to make a decision in respect of whom – a friend or a murderer – he must observe the prohibition. Thus, the moral agent’s willingness to follow the fundamental moral requirement consistently in any circumstances does not guarantee him/her keeping status of a moral agent even if one considers that adherence to a given norm, or set of norms, is the only sphere of responsibility of a moral agent, or the sphere of morality itself in the strictest sense of the word. So, following Kant’s recipe the most probable outcome of the situation will be the following: the friend’s life is sacrificed to the truth, what in the given situation means passing the friend’s life into the murderer’s disposal while the moral obligation of truthfulness is left unexecuted.**

I suppose, that the sources of such kind of predicament are the following, firstly, the idea of a moral agent as separated from all others and abstracted from any reality and, secondly, the idea of morality as exclusively a morality of individualistic perfectionism that consists in a steady adherence to the absolute moral law, or unconditional principles and norms without respect of persons and circumstances.

So in contrast to this approach I assume that it is interpersonal relationships that constitute the peculiar moral domain. Of course, morality orients a human being towards achieving personal perfection and fostering appropriate relationships with others and it does that using general values, principles and norms. But moral perfectionism differs from all the other kinds (creative, religious etc.) in that the efforts aimed at attaining moral perfection are made within the space of human relationships, relevant to them and, ultimately, for their sake. These two orientations (towards personal perfection and appropriate interpersonal relationships) are mutually conditional – one is a necessary pre-requisite of the other. The interdependence of these two perspectives is explained by the fact that a human being is determined inherently by relationships with other people. Thus, Karl Marx regarded a human being as an ensemble of social relationships, and for Martin Heidegger human world in its existential and ontological aspect is a with-world – in other words, *Dasein* is the same as Being-with. In a different context and terms a similar understanding is expressed in feminist ethics of care as well as in some modern (Aristotelian, at least) versions of virtue ethics and a number of other conceptions.

The thesis that human beings are defined by their relationships, their world being a shared world, might seem to imply that personal perfection leads to the establishment of morally significant relationships in and of itself. However, this is incorrect. Care about the Self and care about the Other, or Others, are two distinct moral tasks, even though they are mutually dependent. A person not striving for any sublime ideals is incapable of establishing morally significant relationships with others. The quality of these relationships (moral as well as otherwise) depends on the quality of all their participants. It was showed by Aristotle that a person oriented towards pleasure or efficiency exclusively cannot form the kind of relationships that correspond to the nature and the purpose of human beings. Friendship in its perfect form is only possible as a relationship between virtuous people oriented towards the supreme good. One might also add that outside the perfectionist context caring for another person, or other persons, may degrade to indulging all their whims and weaknesses on the one hand, and paternalism, manipulation and tyranny on the other. However, someone who has nothing but a sublime ideal in mind and consistently follows perfectionist

and ascetic norms may prove incapable of moving towards individual moral perfection when he or she ignores an actual *Other* or *Others*. The latter is obvious in situations when a moral agent follows some norm associated with moral dignity and allows evil to befall the *Other* or *Others*, which could only have been averted by breaking the norm in question. Strict adherence to the norm does not excuse condoning evil or alleviate the **fault of doing so, no matter how sincere and sophisticated** argumentation that used by the moral agent or philosopher to show that it is reverence for the norm and not the person constitutes the moral domain.

The important feature of a moral agent is that he or she is integrated into the real world and is a part of it. This world is the native reality for a moral agent. Furthermore, this very reality in its complexity that is the actual source of problems that gives rise to the need for morality in a human being, and morality is the only possible way of dealing with such problems. A moral agent is oriented towards a sublime ideal, and remains rooted in reality. To use the Kantian metaphor, we might say that a human being as a moral agent belongs to two worlds, the noumenal and the phenomenal. Very important that he/she belongs to both simultaneously. Those who belong to the noumenal world exclusively are not human beings, but rather angels or members of a Kingdom of Ends, none of whom can have any need for morality. They are already perfect and have nothing to prevent them from being in perfect relations with others members of the same Kingdom. By orienting human beings towards sublime ideals, morality does not imply that one should ignore, let alone deny, reality – on the contrary; it requires that one take this reality into account in one's decisions and actions and shows ways of inducing change in it. Taking reality into account means to coordinate one's decisions and actions with specific circumstances and people involved therein, their interests and demands, and thinking of what consequences one's actions might have for others. A moral agent is responsible not only for the execution of the norm as such, but even more so – for the relevance of its execution in the given circumstances and for the consequences that will result from it.

The fact that a moral agent is substantially connected with other people – not merely on the metaphysical level, but on the phenomenal one as well, and deeply rooted in reality – all of this broadens the sphere of



moral responsibility and considerably complicates the solution of moral problems; in some situations, it becomes hopelessly dramatic. No solutions found in such situations can be considered morally irreproachable. However, morality doesn't demand that one act immaculately. It demands one's actions to be most appropriate for a given agent under given circumstances – actions that are ultimately aimed at maintaining unanimity between people on every level – interpersonal, social, cultural and all human.

**THE INTERPRETATIONS OF VIOLENCE AND LIE IN  
EUROPEAN PHILOSOPHICAL TRADITION:  
IMMANUEL KANT**

Kant admitted the possibility of situational deviations from the principle of non-violence. At the same time, he regarded lie primarily as “the greatest violation of the duty of man to himself”. It is important to note that for Kant “responsibilities to himself” that are also “duty to himself” are the most important of all.

Here we already have the main difference between lie and violence in Kant’s theory – namely, that violence, as opposed to lie, although harms homo phenomenon, but is not able to harm homo noumenon. Lie, apart the harm brought to people, harms the person uttering it, and therefore – does harm to humanity in his face. Moreover, lie, according to Kant, is the destruction of human dignity.

This position is probably the most fundamental reason for the determination of Kant’s attitude to lie. My hypothesis is that for Kant lie has essentially different metaphysical status than violence. It is evil in itself, and not only because of its negative effect on a person or society. I will note a few things that point, in my opinion, the main differences of lie from violence.

One of these things is that in Kant’s system lie and violence refer to different levels of “meanness” of the crime. Within the framework of Kant’s ethics, along with the “ordinary” kinds of damage that can be applied, for example, to the violator of moral prohibitions, there are some “special” types which are illegal in themselves. These types of damage

are called by the German philosopher “shameful” and “disgraceful”. And if violence falls under the second type only partially in its particularly perverted forms, then lie entirely falls into this category. For Kant it is important that all such methods by which the other person can be caught on the wrong foot are extremely disgusting. He refers to those lie, murder behind one’s back and with the help of poison.

From the range of violence in this category we have the following actions:

intentional – in terms of Kant man who accidentally poured poison to another person (i.e. the unfortunate chef, but not the person who intended to poison someone else) will not be punished for his mistake, because such result of his actions goes beyond his sphere of freedom to the sphere of causality, over which he has no power;

aggressive – in case of poisoning it is impossible to talk about self-defense;

causing harm not only to the victim but also the murderer himself, or rather to humanity in his face.

Thus, for Kant, only extremely disgusting forms of violence can be equated to lie. It is also noteworthy that all these mean actions Kant regards in “On the ethical duties to others, namely, on truth”. It can be assumed that poisoning and murder behind one’s back are so despised by philosopher *precisely because* they are closely connected with lie, being a kind of “lying” forms of murder.

Noteworthy is the fact that these crimes are considered to be dishonorable not only by Kant, but also by the cultural-historical tradition, as opposed to the “noble” form of murder – in a duel or in a battle. Introducing here the distinction of crimes by their “abomination” – that is, based on distaste for dishonest crimes – the philosopher gets into unexpected correspondence with the principles of aristocratic ethic. At the same time, this principle allows us to give an additional pillar of justifying the inadmissibility of lie.

From this we can derive one quite controversial, but, nevertheless, important consequence especially for the modern discussions about absolutism. It concerns an example of a householder causing the great num-

ber of disputes over, in the paper “On a supposed right to lie from altruistic motives”, by which Kant proves the necessity for truth, regardless of the harm caused by that. If we apply the logic of the previous argument for this situation, we get the following proof of Kant’s position: lie, as an extremely “disgusting” type of crime is the greatest evil, even in comparison to murder, and, therefore, the choice between these two evils should in any case end with the latter. Of course, in this case we take into account not the evil in relation to each particular person, but in relation to person as the bearer of humanity. Thus, we get the “quantity” argument against Kant’s ethics, allowing to suggest that in relation to humanity the harm from lie will always surpass the harm from murder, and no matter in relation to what person the evil is committed.

Another thing that points to the fundamental differences between lie and violence in Kant, is in the principled “formalism” of Kant’s system. The term “formalism” in this case needs to be clarified. We should not forget that it was peculiar to Kant only in the sphere of pure ethics. Most clearly “formalism” of Kant (understood as the taking into account only logical substantiation of a phenomenon, without participation in discussion of common sense) appears in the following argument, given by him in the “Metaphysics of Morals”: “Moments (attendenda) of original acquisition, are the following: 1. Capture of the object not belonging to anybody; otherwise it would contradict the freedom of others”<sup>1</sup>.

The absence of even an attempt to look at the situation from a historical point of view strikes our eyes in this argument. Having even minimal knowledge about the life of prehistoric peoples, it would be impossible not to take into account the fact that for tribalism this system looks the opposite. However, for Kant, the founder of the “critical philosophy” as the philosophy only possible, this approach is more likely the result of a conscious choice rather than a consequence of false data, as it is in the case with Bacon.

The only thing that worries Kant in this case – is the deducibility of all his consequences from initial premises. In fact, even that part of his philosophy that is most closely intertwined with practice (i.e. legal) Kant

---

<sup>1</sup> Kant, I. *Metaphysics of morals*, in: *Immanuel Kant. Works*, in 6 volumes. Vol. 4, part 2. Moscow, Thinking, 1965, p. 171 [in Russian].

is trying to build on the intelligible model, without taking into account the phenomena of empirical world. Of course, the legal system of Kant is based in some sense on the empirical world, and philosopher, as we mentioned earlier, “adjusts” its legal sphere by empiricism, but only at the level of laws, and not the concrete facts, which he often dominated under theory.

It is in relation of lie the formalism mentioned above acted strictly, rejecting it on all possible levels.

Thus, it should be noted that the prohibition of lie is deeply rooted in the system of Kant. In fact, the ban is justified and in the framework of pure ethics (the threat to humanity) and civil law (the impossibility of communication), and even within the framework of natural law (the inability to trust at the end of the war).

In light of the above-stated we can make one more assumption, which, however, will have the shortcoming that is entirely based on speculation, without clear proof in the works of Kant: violence may not be subjected to such strong Kantian criticism, because it is, less common than lie, is the object of its consideration. Violence in Kant’s work is often seen from the instrumental point of view – that is, when considering, for example, the crimes in the field of law Kant does not consider the punishment for this crime from the ethical point of view but finds it as a natural consequence of the crime. The same logic is found in the work already analyzed above, the paper “On a supposed right to lie from altruistic motives”. Kant does not examine specifically the question of “pure violence” – does not argue that there is violence in itself. Meanwhile, as the same issue with lie for him is an important and fundamental, and to this issue he dedicates the special work.

## **MORALITY AS SUBJECTNESS**

The most immediate way morality manifests in human perception is that despite being a purely deterministic creature naturally, socially and psychologically, one can nevertheless act on one's own behalf, acknowledge the action as one's own and oneself as its author. Morally, "mine" translates as standing outside the parenthesis of determination of any kind, including the normative. When viewed through the optics of morality, an action is just as absolute as its subject<sup>1</sup>. It isn't determined by anything other than one's own subjectness, and one recognises it as one's own – quite independently from the extent to which it has been determined by circumstance, to the extent of fully denying the deterministic nature of the action. Even if I kill someone by falling on them from the roof of a building, within the space of morality it shall be considered murder in the fullest sense of the word, and one committed by myself, even if my part in it was no greater than that of a stone. Morality is the core of a human's likeness to God, since one acts on one's own behalf and claims to create the world through action; Christianity expresses this very perceptively as an outright rejection of pride.

Philosophical, ethical interpretation of morality (which is also the instrument of integrating it into culture) is essentially different from how one sees morality through the optics of the social or psychological paradigm, wherein every action is invariably and absolutely deterministic.

---

<sup>1</sup> Translator's note: the author has explicitly requested that the term "subject" should be used in her article instead of the more common "agent".

*The deed of morality is the creation of a space where an action that might be perfectly deterministic outside it becomes the sole responsibility of the subject of morality.*

A moral view of the world is first and foremost characterised by the fact that this world unfolds as the sphere of personal responsibility on the individual level – as “my world,” one which comprises the limitless consequences of my actions. I am essentially incapable of singling out a part that I am responsible for and disregarding everything else, since the very logic of such singling out implies the removal of myself as a subject of morality: after all, by trying to differentiate between that which depends on my actions and that which does not, something that is determined by other powers than myself, such as society, nature, and so on, one will invariably sweep away the entire world on the one hand, since this world is completely deterministic and it is possible to find a reason for anything; on the other hand, one will render one’s subjectness to zero, disappearing in infinity – removing the world from oneself is tantamount to removing oneself from the world. In other words, the only method of keeping one’s own subjectness, or being a subject of morality and responsible individual action, is to accept the *entire* world as one’s own, or a product of one’s own actions. Morality rules out an action wherein the Self would demarcate a separate domain of *my* responsibility, rejecting everything that has been determined by the non-Self – in that case the Self would be completely destroyed by the non-Self, namely, by the contents of one’s mind, one’s biography, psychology, physiology and so on, ad infinitum.

The only basis for an action is the subject’s authorship – the initiation of an action by a subject has no other basis but subjectness itself; otherwise there could be no mention of a subject. This initiating decision is not a cognitive action resulting from a premeditated choice (in that case it would merely be an attempt to make a human being part of the deterministic web using subjectivity as a vehicle). It is merely the decision to act on one’s own behalf, or the choice of own Being – a choice to be, or the choice of oneself above another inside oneself, as Aristotle puts it. Once the action is taken, chains of necessary causality arise – retroactive causality that makes an action determined by social, psychological and even mechanical circumstances ... as well as proactive causality. Basically, all this causality and determinism only express the fact that

an action has been taken, and that it is objectified, material and a part of the world of objects inasmuch as it is deterministic. But the same action also inexpugnably belongs to the domain of morality – for the very reason that it is my action. *Mine* is tantamount to “one I am responsible for.” Responsibility means precisely that, personal acknowledgment – “mine” is one that belongs to my world, which is tantamount to my Self. If we are to think of a certain abstract source of inquiry that keeps asking but one question, the very question that a mother asks to a child that has done something untoward, or, on the contrary, one that has excelled in something, namely, “Who did it?” – responsibility is the answer, “I did!” It is the first and the last manifestation of the subject. However, the subject of morality is one-and-the-only – there is no one who could ask this question without transferring the subject into the social space (even God would negate the subject by asking it). Asking this question of oneself translates as splitting the Self in two, with the same consequences. “Mine” is the answer to a question that does not exist and has not been asked – a gesture, an answer that allows for no question. Moral responsibility is not a response to an inquiry by someone else or an answer to a question asked of oneself by oneself. It defines the very entity that could ask and answer: “I” and “mine” are the very same. The subject of morality is outside the frameworks of space and time, logic and linguistic structures, cognition and, of course, outside of, and independent from, any manifestation in the language of morality. Once we begin the discussion of moral phenomena as they are seen from without, we cannot use our thought to place the subject inside a world that is invariably void of subjects. In this case, all we deal with are objectified subject-less actions, products, meanings etc. There may be legal or social responsibility in this world – but not moral. There is nothing we can do with moral responsibility – we can neither demand it, nor describe it. What we often call a moral sanction or judgement is merely a form of social sanction – it may not be quite identical to legal sanction, but it complements it and exists in the same social space.

One breaks the web of causality and defines oneself as an autonomous entity by acknowledging one’s action, and thus also the world, as one’s own – absolutely and originally so, outside and regardless of any determination whatsoever – precisely by owning up to one’s action, even if it can be ascribed to someone or something else from the point of view of



sociology, psychology and the laws of mechanics. This appropriation of the world and establishment of oneself as the responsible entity regardless of the specification of one's own conscious participation, calculations, the isolation of intent etc – regardless of everything that idea of legal responsibility is based upon, one defines oneself as its single and absolute source: thus, moral responsibility is a precursor of freedom. But is freedom needed for the appropriation of an action? Basically, if it is of no importance for moral responsibility whether or not an action is taken in a free environment and if it does not require freedom as a condition for existence, the concept of freedom is absorbed by those of autonomy and absoluteness, and becomes banished to the outskirts of the basics of moral existence, or the domain of legal and political thought. The subject cannot be free or non-free – one precedes, or, rather, overcomes this dichotomy utterly, ignores it. It belongs to the realm of non-subjectness, or view from without.

When society resolves the issues of legal responsibility, it breaks the chains of causality in a specific place defined by consensus and draws a line behind which a person is considered the author of an action, the responsible party. The actual person can only draw the same distinction by taking an external view – by regarding himself or herself as a deterministic object, thus giving up the claim for subjectness and objectifying the Self. Moral responsibility is an assertion of subjectness without any distinction between what does and what does not depend on oneself. Its basis is that human beings bear moral responsibility – not in local corners overlooked or ignored by necessity and not indeed in any deterministic space, but rather an altogether different domain where the subject of morality is the sole and absolute source of an action; seeing as how the action itself has meaning and consequences projected into the endless future, also pulling towards itself all the endless connections of the past, one's responsibility covers the entire world and everything that has been happening within it. Any attempt to limit a subject's responsibility transforms him or her into a deterministic objectified entity, which is why moral responsibility can only be absolute, likewise subjectness itself. I am the one who overcomes my *subjectiveness* by reaffirming my *subjectness* – I sweep away the importance and influence over my responsibility for the world and my appropriation thereof all of my subjective motives, intentions, ability

to cognise and understand the world in general as well as every particular situation when I take an action. This is the very reason why I am capable of taking actions, or acting on my own behalf, in situations of insurmountable ignorance. By taking an action, I acknowledge the entire limitless multitude of causal links engendered by this action, or appropriate the entire space of necessity and use myself to fill it with Being. This is how the subject eliminates subjectivity and reaffirms the world in its existentiality.

Morality is the space within which there are no deterministic relations but only identity, sameness, oneness. That is why when describing morality we speak in circles: the virtuous act is an act initiated by a virtuous person and a virtuous person is the person who acts virtuously. And the same absence of the causal relation we can find speaking, for example, about freedom and responsibility, action and the subject of the action, etc.

The essence of morality is not the exact nature of forms or values, but rather the fact that it is my own subjectness. The notion “I think” is an action, since it implies that I consider my cogitation and its results my very own and assume responsibility for them, their truthfulness and the entire endless multitude of all possible consequences of my thought, ideas and knowledge. My every action alters the entire structure of the world – its future as well as its past. In this sense, I am the subject of the entire human history, as well as its embodiment – in my being one-and-the-only. Am I not responsible for the Holocaust, the Inquisition or the death of Socrates? Anyone who gives a negative answer disappears from the moral space and perishes as a subject. If you estimate something morally it means that this event is your own action: otherwise you can’t estimate it.

Subjectness makes everything that is considered to represent the essence of morality possible, and engenders something essential all by itself: within the space of subjectness “Thou shalt not kill” and “Lie ye not” stand for an impossibility and are not prohibitions – a subject of morality cannot kill or lie without destroying or cancelling his or her very subjectness. This impossibility of one’s own Being within non-Being manifests as the absoluteness of the moral prohibition – in other terms, the absolute nature of the prohibition is a form of subjectness.

The subject of morality is essentially one-and-the-only – an action cannot have two authors, just like the world of values cannot have two centres. Thus, if the Self turns out to be Hume's bundle of perceptions within the space of perceiving the world, if it dichotomises in the space of thought, as Socrates would put it, and if the Self denies itself in objectified knowledge in the space of cognition, it is in the action and in the action only that the Self represents the central onliness as Bakhtin's obliging onliness, which guarantees the universality of morality. Only the oneness-and-onliness of a moral human being can engender the existence of the Other as one's own – as unobjectified existence.

Within the space of morality a human being is essentially unequal to others and utterly alone in creating the world through action and in his or her own responsibility for the world. One is all the more alone in action than in cogitation, in which one finds conversation within oneself. In action one is absolutely one-and-the-only, but not singular how a person is singular within social space.

Morality is essentially impossible to place in the same row with any other phenomena as it is the background which makes any personal authorised act possible – in any sphere of human life and activity. It is manifest as an individually responsible action regardless of its regulatory or axiological peculiarities. This assures the futility of any attempt to define morality by pointing out its specific characteristic and trying to fit it into some category by accentuating some of its attributes: a regulative or normative form (as compared to law or tradition), axiological consciousness (as compared to science or art) etc.

I would opine for the philosophical and ethical definition of morality to be as follows: morality is subjectness. This is a tautology, but the only way of referring to the absolute source of everything is to multiply its names – it cannot be traced back to anything else.

*Translated by Michail Yagupov and Olga Zubets*

## IV. ANTHROPOLOGY

*N. Kasavina*

### THE BASIC CHARACTER OF EXISTENTIAL EXPERIENCE

The category «experience» has numerous interpretations in science and philosophy. However, it has not lost its relevance and requires conceptual elaboration and empirical study. This is due, on the one hand, to the methodological shifts in the understanding the nature of knowledge and justification of its validity, that is, to those concepts, which provide the systematic unity of experience. On the other hand, the philosophy of experience influenced by phenomenology and existentialism turned to the subjective, personal dimensions of experience.

Traditionally the experience was treated in philosophy as a perceptual cognition, which provides immediate certainty of the object. The largest contribution to that understanding of the experience has been made by British empirical philosophical tradition, originating from the D. Locke, G. Berkeley, and D. Hume<sup>1</sup>. Experience was opposed to reason. Reason served to differentiate and compare the sensations, to understand their value. The epistemological priority was given thereby to the original perceptual experience.

Such a narrow interpretation describes the experience more as a result of the passive perception of the external world. The role of semantic contexts, rational premises of sense perception has been essentially di-

---

<sup>1</sup> Berkeley, G. An Essay towards New Theory of Vision; idem, A Treatise concerning the Principles of Human Knowledge, in: *G. Berkeley. Works. Composer by I. NarSKIY*. Moscow, 2000 [in Russian]; Locke, D. *An Essay Concerning Human Understanding* / Ed. with an Introduction by Peter H. Nidditch. Oxford, 1979; Hume, D. A Treatise of Human Nature, in: *D. Hume. Works in two vol.* Moscow, 1965 [in Russian].

minated. However, the specificity of the human attitude towards the world goes far beyond elementary sensations and feelings. The conceptual continuum of experience in culture, communication, behavior and human existence was opened much later. Besides all, philosophy had to learn much from theology and religious thought in order to understand what constituted experience in its universal and spiritual dimensions.

Phenomenology singled out experience as one of the basic concepts. The a priori forms, which Kant attributed to pure sense perception and categories, have been incorporated into the core sphere of knowledge. Under the influence of F. Brentano, E. Husserl<sup>2</sup>, W. Dilthey, M. Scheler, M. Merleau-Ponty<sup>3</sup>, human experience has been regarded as a complex system of values, concepts and perceptions which gives access to the nature of human existence though needs deciphering using the concepts of knowledge, experience, meaning, existence, the dialogue.

Later experience as the deepest foundation of life has been recognized as a prerequisite of the entire sphere of knowledge. Phenomenology reestablished Kant's teaching about a priori structure of the cognitive consciousness for the understanding of the fundamental dimensions of perceptual and emotional consciousness. This was partly a synthesis and generalization of the classical transcendentalism. From there on a movement started to understand any experience as essentially existential and only then – actually cognitive.

The role of pragmatism<sup>4</sup> – Ch. Pierce, W. James, G. Dewey – is manifested in attention to the social nature of the experience. For pragmatism, a human experience as purposeful activity and a result of human interaction with the environment includes conceptual-semantic boundaries (social, moral, aesthetic, political, and religious ones), within which the interpretation of the different situations takes place.

In general, these philosophical trends accentuate the role of reflection and interpretation in experience, and importance of social and cultural spaces, in which experience is formed and practiced. They gave a pow-

---

<sup>2</sup> Husserl E. *Die Idee der Phänomenologie*. Fünf Vorlesungen. Den Haag, 1950.

<sup>3</sup> Merleau-Ponty, M. *Le visible et l'invisible*. Paris, Gallimard, 1964.

<sup>4</sup> Dewey, G. *Experience and nature*, New York, 1958; James, W. *The Varieties Of Religious Experience. A Study Of Human Nature*. New York, London, Bombay: Longmans, Green and Co., 1902.

erful impetus to the understanding of the personal experience of existence, which in the expanded version became the subject matter of the existential philosophy.

The experience in the existential philosophy is a content of the agent's inner world, albeit being laden with alienation and anxiety, still provides a possibility of genuine human self-realization<sup>5</sup>. The main position is occupied by the question about the meaning of the unique human personality, its own way of being. Existential experience is understood as a deep knowledge being born in activity and communication. It represents a spiritual being of a person, the solution of the fundamental questions of her existence: relationship to death, belonging to the world, overcome loneliness. It lies in the very roots of human being and determines local and specific life goals.

Within the background of the existential philosophy, existential sphere has been often understood as opposed to the daily experience in terms of the difference between unique and standard situations. Revisiting the existential philosophy standpoint, one has to turn back to the concept of experience and to undertake its conceptual elaboration. Perceptual experience is in fact a starting point of the existential experience and reflects the agent's contact to the world in all events of human life. However, experiences that can cause personality changes presuppose structuring and rationalization. Experience is substituted under the concept or idea, while a person tries to fix it in language and communication. At the same time a man builds his own picture of the world with the help of a pattern that originates in generalization and reification of a specific situation experienced and observed in daily routine. In this regard the category of existential experience refers to a set of cultural universals (O. Spengler), historical a priori<sup>6</sup> basic values. The person experiences reality in accordance with the cultural sample values and archetypes.

Thus the opposition of existential and daily experience is relevant only as a certain abstraction, as the difference between the correspondent concepts. In fact, any real life event has daily and existential, perceptual and conceptual sides. Obviously, the daily experience is a background

---

<sup>5</sup> Heidegger, M. *Sein und Zeit*. Halle: Niemeyer, 1927; Hume, D. A Treatise of Human Nature, in: *D. Hume. Works in two vol.* Moscow, 1965 [in Russian]; Sartre, J.-P. *L'Être et le néant. Essai d'ontologie phénoménologique*. Paris, 1943.

<sup>6</sup> Husserl, E. *Die Idee der Phänomenologie*. Fünf Vorlesungen. Den Haag, 1950.

of existential experiences. But in addition, existential experience can be seen as a synthesis of human life, the outcome of situations ranging from childhood, patterns and models of behavior and assessment. It is an experience that is formed not only from scratch, suddenly and occasionally, but regularly, gradually, sequentially. Even if an immediate existential experience is an emotional experience connected to the significant events of life of the person, it still involves semantic and value parameters of one's relationship to reality and to oneself.

Existential experience of a person is formed indirectly when it grows out of the perception of life situations occurring with others, empathically, as well as through acquaintance with artistic events (especially literature, theatre, cinema), which demonstrate existential situations in the objective cultural artifacts.

Hence the understanding of existential experience as a phenomenon of individual existence and personal development deserves its complementation by the socio-cultural context of its formation. The cultural-historical type of existential experience is a combination of reified existential experiences. Existential experience, acquiring the linguistic and symbolic form in communication, appears a socio-cultural phenomenon and is included into a cultural tradition due to its interpretation and generalization of life events.

Existential experience, therefore, acts as a synthesis of the individual and the collective: it is largely cultural, but moving through time, constantly reproduces the problem of personal existence. Existential experience is not just a set of experiences, but a particular product of their integrity, decrypting, untangling, each time leading to a new milestone of personal maturity. Existential experience is a personal history of existence, during which the man clarifies the key values. It is also a way of reconciling oneself with one's existence, of continuous listening to life, a spiritual awakensness, overcoming anxiety.

Existential experience is an experience of the problematic existence; it covers the situations of the conscious personal choice, which is inseparably connected with doubt. It is the experience of overcoming spiritual dissatisfaction that changes the entire life world and personal attitude to oneself. A man never finds a final meaning in the everyday social reality. So he remains always unsatisfied, and this dissatisfaction is an indicator and root of existential quest.

In conclusion, the so understood existential experience can be hardly seen a separate experience type aside a number of other types of experience, like casual, religious, mystical, scientific, moral experience. The latter are much more a particular embodiment of human existence. In contrast to that, existential content penetrates the entire structure of experience: everyday life, social interactions and activities, religious, mystical and aesthetic search for unity with the world. An existential conflict or crisis can occur in every moment of life. In various situations, existence, everydayness and sociality are included into dichotomous relationships, where one defines another, serving as its condition and consequence, changing their places.

The idea of universality and basic character of existential experience has to be taken into account, if we tend towards a positive interpretation of existentialism<sup>7</sup> and to a proper understanding of the entire human experience and the life world.

---

<sup>7</sup> Bollnow, O. F. *Neue Geborgenheit. Das Problem einer Überwindung des Existentialismus*. Stuttgart, 1960.



## **WHAT HINDERS DEVELOPMENT OF MODERN MAN**

The way out of the present global anthropological crisis is to learn to distinguish between types of matter that contribute to personal development and those that hinder it. The crisis's major feature is the growing inability of contemporary person to identify the goal of individual life and make the latter personally meaningful. This results in the persistent tendency to avoid making key choices about vocation, marriage, children, in short, about everything that makes life worth living. The Congress's theme Philosophy as Inquiry and Way of Life seems, therefore, topical: is it not philosophy, indeed, that encourages one to inquire about the meaning of life and develop a way of life that fills it with personal meaning?

The extinction of many ethnic groups nowadays is the result of the undue relations between the population and the individual organisms. This has led to the cult of individualism and hedonism, the precedence of rights over duties, perversions presented as norms, l'ennui de vivre, and the lack of will to change the situation. Mass media spread fear. People opt to identify with artificial groups, like fans of Apple who view themselves as a group sui generis rather than customers buying products of the same trademark. Another key example are members of the numerous social networks.

When in 1879 Wilhelm Wundt founded the first psychological lab at the University of Leipzig, scientific analysis of high psychic functions replaced philosophical and religious speculations about human soul. The

essence of the resulting revolution in world outlook can be summarised as follows: the notion of soul as a kind of entity communicating with the material world and the divine world as two other entities yielded to the understanding that each psychic function is dealt with a specific kind of matter independent of other kinds and irreplaceable by them. Memory, e.g., deals with former matter that can never become actual; adult thinking operates with abstractions that have nothing analogous in either the living or in the dead matter (the material world has nothing like a mathematical point), etc. Thanks to Wilhelm Wundt and his followers, we are now aware of the correlations between high psychic functions and the various worlds (with humans at their junctions). Besides, thanks to Wundt we can now measure memory, attention, perception and intellect.

The psyche is an instrument that supports movement. The senses of seeing, hearing, smelling, touching and tasting are the capacities required for the effective functioning of the vestibular system. By having learned to measure the five analyzers (all except the motoring), we have acquired the capacity to create artificial worlds in which the vestibular system is not necessary. Cinema was developed after we discovered that 18 photographic pictures are perceived by us as just one image.

Personal needs and motivations depend on how the motoring analyzer functions. Hypodynamics result in reduced desire to live and develop. It is not surprising then that it was about that time (130 years ago) that one could witness a new form of intervention into the inner personal world, viz. wide use of psychotropic substances hitherto unknown in Europe. Such psychotropic substances are a kind of shadow neuromediators, or, to put it otherwise, former matter undistinguishable for the human organism from the naturally produced endorphins, endogenous alcohols, etc.

In 1883 Wundt's pupil Emil Kraepelin published his *Textbook of Psychiatry*, the first book of this kind in human history, in which he identified a number of mental illnesses and demonstrated the existence of people whose unique worldview prevented them from communicating with other people. Sigmund Freud and his followers based their theories and practical recommendations on the assumption that human psyche is not an integral entity, but a kind of battlefield between what

Freud identified as ego, id and superego. Psychiatrists have described dissociation disorders characterized by consecutive appearance in an individual of different personalities, highly developed and integral in themselves. Examples can be cited of up to 20 alternating personalities within a single individual.

Finally, studies of altered states of consciousness have revealed that transition from one state of consciousness to another can result in cardinal change in person's high psychic functions. To sum up, development of science in the course of the last 130 years has undermined belief in the natural unity of human psyche. The very possibility of individual psychic development depends on the correct identification of the main psychic function, the main analyzer and, consequently, the main kind of matter.

Following the works of the distinguished Soviet psychologist Alexei Leontiev it has become customary to speak of the main (leading) kind of activity that determines personal development. For children of preschool age this kind of activity is play. Nowadays, play activity has become abnormally widespread to include people of mature and even old age (this phenomenon is mentioned by Johan Huizinga in his pioneering *Homo ludens*). Customers are encouraged by trading companies to compete for prizes; events of play nature are presented as news (as in Victor Pelevin's *S.N.U.F.F.*); entertainment has become a major problem that requires enormous resources, both material and human. Excessive entertainment prevents maturing.

Upon discovery of viruses by Dmitry Ivanovsky in 1892 humankind was faced for the first time with former living objects of which by-products of respiration, nutrition and excretion could not be measured. It was only 118 years later that the biological genius of Sergey Ostroumov concluded that former living matter did not become dead matter, so that we had to deal with some third kind of matter, neither living nor dead<sup>1</sup>. Contemporary medicine is still at a loss about former dead objects. Viruses are not harmed when denied oxygen or water. Moreover, it is not viruses that kill people: if the patient dies, the death is due not to viruses, but to medical treatment of viruses.

---

<sup>1</sup> New typology of matter and the role of ex-living matter (ELM), in: *Ecological Studies, Hazards, Solutions*. Vol. 16 (2010). Pp. 62–65.

Well, if there exists former living matter, why cannot there exist former dead matter? After all, material information carriers we create (computer software, books, films, photos, etc.) can be activated and used in human intercourse and cannot thus be equaled to dead material bodies untransformed by human activity. We cannot measure the amount of by-products of respiration, nutrition and excretion for former living objects; we cannot likewise measure the weight, length, width or height of information carried by former dead objects.

Consider, for example, money that now exist mostly in the form of computer records. It takes 5 milliseconds to transfer money from one country to another, whereas human time perception threshold is 55 milliseconds, i.e. one order of magnitude higher. Change of property rights with money transferred at this speed makes it technically impossible to identify the owner.

The U.S.A., Japan, the U.K. and E.U. countries increase emission of currency. The last two years saw \$ 1.5 trillion and € 1.2 trillion unbacked emission (with comparable amounts in yen and pounds). This means that Earth dwellers were deprived of some \$6 billion worth income (almost \$1,000 per capita) in the course of just two years, and that without major wars, crises or natural catastrophes. According to some estimates, the amount of money emitted in the last three years equals that emitted in the previous 300 years. This is how former money affects our economies and lives. The process accelerates at the rate that makes one think of division by numbers close to zero.

The general feature of former matter is that it cannot be measured, like one cannot measure dreams or hallucinations. Upon world-wide ban on the gold standard a unit has come to be seen as a point rather than a distance between two points. In other words, we now use order scale instead of the interval scale to measure work in money terms. Order scale allows to determine which name is farther from zero or closer to zero, but does not allow for arithmetic operations involving names.

To consider this issue philosophically we must keep in mind that living systems continue to exist as long as the organs responsible for the discharge of former matter continue to function.

The cause of global anthropological crisis and, incidentally, the major feature of contemporary management is the feedback from former matter. Signals of this kind received by analyzers that link people with

their environment are like mathematical points. It is not by coincidence, perhaps, that forms of indirect control (without orders and commands) came into existence about the time when painters started to create images out of dots (impressionists) and simple geometrical figures (van-guardists). What image comes out of these dots and figures depends solely on the imagination of the viewer.

After 1945 states no longer declare wars on each other; this means that a military conflict involving foreigners can be optionally viewed as a war or liberation, a criminal terrorist attack, or a humanitarian intervention. What is going on, or rather the perception of what is going on, depends on one's imagination. No formal judicial judgement is possible because contemporary states do not declare wars. Do they not thus turn into "former states"?

Pr. Nazaretyan argues that it was dread of former living matter (kin corpses) and dread of posthumous revenge (resurrected dead seen as more frightening than the alive) that allowed humans to distinguish themselves from animals which show no such fear. We now have to make the next step in our development, viz. learn to distinguish between past and actual, stop worrying about past somehow becoming actual, plan for future without looking back to past in fear. All this can be achieved if our reference is to our vestibular system rather than our visual or auditory analyzers.

To sum up. Attempts at indirect development management have led to their logical end: what affects human senses is no longer actual matter relevant to our life activities, but former matter, both living and dead. Our discharge systems, both individual and social, fail to help organisms to get rid of former matter. The solution that will allow for our future development might be broadening the repertoire of motor patterns, with the vestibular system playing the key role. This is the only way to restore vital links between individuals and their populations.

The Russian national idea is the expansion into the unknown. Mastering new motor patterns will set up a barrier against negative influence of former matter.

## **VIRTUALISTICS AS A PHILOSOPHICAL AND ANTHROPOLOGICAL TURN IN HUMAN SCIENCES**

Virtualistics as a paradigmatic approach, as it's developed by the Soviet-Russian school of N. A. Nosov (1952–2002) laid the foundation for the ontological understanding of a person's inner space, whatever one might choose to call it : psychological, anthropological, subjective, spiritual, etc. The virtual approach has its own philosophy, methodology, experiment and study object – the reality (objects) – virtuals existing in a person's inner space in a temporal, energistic form. These objects, akin to the virtual particles in physics, are absent at the beginning and the end of the event (interaction). Virtualistics operates on a categorical opposition “constant-virtual” – “generator-generated”, differing from scholasticism in that virtuality is not opposed to substantiality (in the modern mainstream of computer virtuality – corporeity), but rather to constancy – generating reality. The realities, objects-virtuals can be of any nature, including of not psychological (yet the Nosov virtualistics deals mainly with virtual psychological realities). For the most part their nature is complex and integrated, therefore placing them in the area of interdisciplinary studies.

Let's note that the computer virtual reality would not function if the natural virtuality of humans didn't exist. Unfortunately, most studies of the Internet and cyberspace leave a person's inner world out of the equation. Or they switch to the reductionism models: psycho-physiological, humanity- and personality-based, etc. It is clear that attempts to reduce a multidimensional space to one (single) dimension are counterproductive, although technically possible, and often

cause a known scientific interest and provide a pragmatic result. A categorical opposition is relative: a virtual reality might become constant for the virtual reality of the next hierarchical level, etc. A reverse process is also evident: a virtual reality can get reduced to an object of constant reality. There are no theoretical limits to the number of such emanations. The virtuals system has only “resource” limitations and limitations on the physical implementation of certain interactions because of their natural qualities. Such approach to virtuality entails polyontism and polyontological nature – the multiplicity of realities and worlds in which a person exists, with a corresponding structure of virtuals (objects of person’s inner world), as confirmed by a series of dedicated experiments.

The work of the Study Group “Virtualistics” of the Institute of Philosophy of the Russian Academy of Sciences (in 1991–2004 – Virtualistics Centre at the Institute of Human Research of RAS) demonstrated that the common categorial net current-potential, essence-phenomenon, abstract-specific, ideal-material, real-virtual, etc. is not adequate to describe the objects of person’s inner world. This statement is precisely the essence of a philosophical and anthropological turn in the humanitarian sphere, the sphere of the human sciences.

The subject of the research which gave life to virtualistics, the basis of its origin was chosen to be an error – an “aircraft belly-landing” (similar to such errors as mistaking a person for somebody else, a misspelling, somebody mispronouncing or mishearing something). Followed by an alcoholism clinic, psychosomatic disorders, phobias of opera singers, post-traumatic stress disorder, and so on. Today the list of the titles by the “Virtualistics” Study Group contains over 30 large-scale works: monographs, brochures, manuals, etc. ([www.virtualistika.ru](http://www.virtualistika.ru)).

The very preparation process of these research results may be called “experimental philosophy” (theoretical models and concepts are cross-checked in a special experiment where phenomenology is generated and falsified). Today these results allow us to speak with confidence about the philosophical and anthropological turn in the human sciences.

The fact is that having remained a long time outside the scientific mainstream, virtualistics has formed its own conceptual apparatus, own theoretical models. In particular, it is the concept of a virtual human

(virtus (lat.): a special state of power, valour and courage of a warrior in a battle; or Virtue), whose level of system realisation helps obtain many of the existing theoretical concepts of psychology, medicine, management, anthropology and epistemology as a particular case. This possibility is due to the high degree of this concept's hypercomplex variety: the realities of corporeity, consciousness, identity, will, and the inner man (each of them, in turn, is also multi-dimensional). Knowledge of this concept's theoretical structure and identification of its current structure in a specific individual predetermines the theoretically possible as well as physically realisable states and events in the event-procedural space of the particular person's psyche.

Virtualistics identified, described and introduced into scientific use the phenomenon, the concept and the theoretical model of a virtual event, the virtual, by defining its following attributes. Generability, currency, autonomy and interactivity (1986). Later (1991) the 8 signs of a virtual psychological event were described (see the Dictionary of Virtual Terms, fully available on [www.virtualistika.ru](http://www.virtualistika.ru)). The latter are further divided into consuetal (ordinary) and extraordinary: gratual and ingratal, of positive and negative character respectively. The character, mood of an event is defined by the person experiencing the current state. It can be defined as light (gratual – from Latin “easy”, “bestowed”), or on the contrary, as dead-end, difficult, confused (ingratal). These states are devoid of an object – in other words, they can occur in connection with any kind of activity (professional, physical, psychological, individual, group, etc.; it serves as another confirmation of the fundamental nature of such events / experiences / states). And because of such objectlessness they can be seen as indicative: as indicators of normal / unusual progress of a particular state / experience / event.

Thus, virtualistics believes psyche to be a generated entity, a virtual psychological reality of the first hierarchical level – a protruding capsule for all the other realities (the conscious, the subconscious, the unconscious, the controlled, etc.) and phenomena (attention, perception, memory, etc.) that are studied by monoontic sciences (in effect, all the modern ones). In other words, the structure of psychic reality – the constant structure of its vertices (physically implemented in the specific individual as a consuetal reality) in the hypergraph of a virtual human –



determines the multitude of possible physically realizable events in the space of possible physically realizable states. Once again, we emphasize that the physical here is opposed to the theoretical.

These and other achievements of the virtualistics allow us to speak about the new paradigm revolution in the human sciences.

So, let us take a closer look at some of the schools of virtuality understanding predominating in the modern Russian science and philosophy – and compare them with N.A. Nosov's approach. Generally, in this respect the prevailing part of the Russian scientific and philosophical thought is not very different from the West, with the attempts to understand virtuality prevailed by the traditional paradigm across all schools of thought.

Both in the mainstream scientific and in the everyday thought virtuality is of course primarily associated with computers. In a certain way this is an expression of coarse materialism. Whereas when applied to virtualistics in Nosov's understanding, these are merely "epiphenomena". Computer virtuality would not have functioned without the functional existence of a natural human virtuality. Man's virtual nature in this area of philosophical and anthropological thought is usually left out of the equation. Yet this nature, the man's inner space, as already briefly noted above, holds all the "wonderful mechanics" of technology's and its virtual reality's magical power. The magical power of substituting the "real reality", as it is commonly referred to by the Internet theorists, of "virtual-computer cyber-reality" is born out of the phenomenon of "non-distinguishing" described when creating a theoretical model of the error "airplane belly-landing".

The non-distinguishing phenomenon is based on people not distinguishing between the fact that the generated image of activity is engineered, designed, put together from elements of different realities: an objective reflection of the outside world, and elements that do not have representations in the outside world, the results of own, intrinsic activity of the human psyche. In other words, the process of objective reflection is intervened by the "evil factor", the polyontism of activity space: an "objective image" consists of elements of different realities but it is seen as an objective reflection of anyone of them. This leads to the situation where an on-board engineer on an airplane checks the flaps

when lowering the landing gear and believes that he has indeed lowered the landing gear (the phenomenon of completed / non-completed of an action: the non-completed action is perceived as completed, and vice versa). The result: belly-landing of the plane.

The modern scientific mainstream does not have a theoretical model for an error of psychological nature (subjective in the mainstream scientific understanding) – when people forget, get confused, etc. The categorical and conceptual tools for description of the external world do not give scope to reveal the objectivity mechanism of a psychological error. An error is generated due to the fundamental properties of the psychic space – polyontism, heterogeneity, generability, hierarchical nature, currency, autonomy, and so forth – that is why a psychological error is objective. Combined together, the above factors lead to a variety of epistemological incidents: verbosity, futile attempts to define virtual reality through blight, unreal reality, invalidity, potentiality, etc. Moreover, to this date in mainstream psychology the problem of errors (belly-landing) has not been solved!

The second intension distinguishable in the main body of research works is not less evident. It is coarse idealism: image of an event will soon replace the event itself. This certainly does not please us, virtualists: an image of bread will replace the bread itself, an image of subway – the subway itself, and an image of the XXIII World Congress of Philosophy will replace the Congress itself.

Another stable scientific and philosophical direction, associated with the name of late Igor Akchurin, is run by a group of colleagues exploring the manifestations of virtuality in physical reality (E. A. Mamchur's sector at the RAS Institute of Philosophy, as well as other researchers in their collaborative network). Right now we won't dwell on this area: the philosophical and anthropological problematics (the problem of an observer, etc.) is not central to this area of thought.

Now we should also mention virtuology and its attempt to create a new scientific field that studies virtual reality. Virtualistics presumes that the world is virtual: consisting of realities that exist in virtual relationships – the generation-generated, (constancies-virtualities). Therefore a person is a virtual reality. Here we must define the latter, which was already partially done above (see the works on [www.virtualistika.ru](http://www.virtualistika.ru)).

The virtuology of man, seeing how it is being developed on the basis of the traditional paradigmatic systems, on the philosophical and methodological level will merely repeat the traditional anthropology... We will touch upon this subject again below, when we review the paradigmatic revolution – an injection of virtual thinking.

And finally, once again about another component which for more than 25 years has remained on the periphery of the prevailing scientific stream. We are talking about Virtualistics in the narrow sense of the term – in the understanding of N. A. Nosov's school (who, by the way, was the one to suggest the term). About the direction that laid the ontological foundation for understanding of man's inner space: the concept of "virtual human" as a theoretical construct of a categorical level of generality offers new opportunities for understanding the man. How did this philosophical and scientific area of thought eventually manage to break free from the autonomous "isolation"?

It is encouraging that during the last World and All-Russian Congresses of Philosophy and Philosophy Days in St. Petersburg there is one continuous trend. There have been more and more "aligned" works from other colleagues outside of our immediate circle of collaboration and socialising. What do we mean by that? Until recently, the body of works of RAS Virtualistics Centre and the Study Group "Virtualistics" of the Institute of Philosophy of the Russian Academy of Sciences has been formed almost entirely by its immediate staff and their closest colleagues. Today at various congresses and readings we encounter previously unknown researchers and scientists who speak one and the same language with us. ("One" in the virtualistics language is a point of section of orthogonal projections of a multitude of realities: an obvious polylogue.) You must agree: it's definitely a notable milestone on the route to establishing a new area of philosophy and science.

We must also highlight the role of international and national forums, and the Philosophy Days in St. Petersburg in particular. The role that their organizers, the governments and administrations of the cities and regions play in shifting the situation and implementing a new paradigmatic approach in the philosophical and scientific consciousness. In the formation of a new paradigm revolution. And it is not just a set of the usual ritual phrases, not the obligatory praise with regard to the orga-

nizers supporting the generation of such spaces. And not some empty statements – here we are talking about an event, the actions already in motion. But in a certain order, with some important highlights.

Perhaps this part of the thesis may seem at first glance, and then only at first, not so scientific. But the philosophy and science are social. They are a social, organizational, cultural, human space – the environment for their formation, development and dissemination. There must be a particular place, conditions and so on where the paradigmatic implementation of a new mindset in the scientific and philosophical consciousness can happen.

And this very context of personal, human interaction that is created by the International and the Russian Philosophical Societies, the space of the international and the Russian congresses ( the Second Russian Congress began to run the round table “Philosophical Problems of Virtualistics”) and conferences helped us attract the attention of our colleagues to the Nosov paradigm, to demonstrate its relevance and the route of its development (the works of M. A. Pronin, G. P. Yuriev, Y. V. Chesnov, A. D. Korolev, V. F. Zhdanov, I. I. Silantieva, S. V. Poltayko and others). This context is the very infrastructure required to breed innovation, and it is what the International and the Russian Philosophical Societies stand for.

In conclusion we would like to dwell on a few more key points essential for understanding the paradigmatic revolution proposed by Virtualistics.

Virtualistics as a paradigmatic approach is developing a philosophical anthropology that would be adequate for working with the objects generated in a person’s inner space, devoid of a mode of permanence, “eternity”, existing in the acting, current, energetic, temporal shape – the example was taken on the basis of psychological errors. With respect to this mode, a similarity can be found with the virtual particles in physics which are not present at the beginning or at the end of the interaction of the particles that create them. The study of microcosm – including the special nature of virtual particles – demanded of the physicists a comprehensive re-examination of their philosophical and epistemological systems. Again, our research shows that the categorical grids adequate to the description, understanding of external reality (essence-phenomenon, ideal-material, current-potential, abstract-concrete, etc.) are not

suitable for working with objects of a man's inner world. That is – with the objects that are generated and dissolved faster than the proverbial “25<sup>th</sup> frame”, such as the “belly-landing” error and other psychological errors such as misspelling, mishearing, mistaking an object or a person for another one, etc. As well as the objects that trigger addictive conditions: alcoholic binge, kleptomania, gambling addiction, etc.

The problem being that most scientists and researchers of these phenomena still haven't been able to bridge the paradigm gap with the means and framework of the scientific mainstream.

It might be useful to discuss the structure of philosophical and anthropological turn in the human sciences taking the case of psychology as an example. Taking as the example the structure of professional training “as is” and “as it should be”, to use the language of organizational changes.

Today it is evident that it takes not only the organizational synomia – the consolidation of spaces of natural sciences (talking about the sciences in Russia in particular, placed under the authority of the Russian Academy of Medical Sciences), humanities and philosophy (the “titular province” of the Russian Academy of Sciences), but also the paradigm synomia, today made possible within the virtual approach.

The synomia must be supported by the concomitant serious preparation in the field of linguistics. The study of the second-signal system – the language that predetermines a person's status as such, which by now has almost completely fallen out of the psychologists training program. However, this is a subject for further discussion.

Today, however, we have already seen a qualitative leap: our works, the promotions infrastructure (websites, conferences, readings during the Philosophy Days in St. Petersburg, personal correspondence, etc.) led us to a new breakthrough. The N.A. Nosov Virtualistics School now has a steady feedback of scientific and philosophical thought: a process of wide dissemination of the new philosophical and anthropological view across the body of human sciences.

## **BOUNDARIES OF INDIVIDUAL HUMAN EXISTENCE AS ZONES OF ENGINEERING INTERVENTIONS**

One of remarkable tendencies characteristic for technological progress of the last decades consists in rapidly growing development and use of new technologies for direct influence upon humans. Surely, every technological innovation, every engineering decision is aimed at performing some change in the world around humans and in this sense at exerting influence on them. Yet biomedical technologies (and to essential extent modern information and communication technologies as well) are technologies of goal-directed interventions into human body and/or mind<sup>1</sup>. In other words, they are applied inside the space of individual human existence. We shall term these technologies human-directed, taking into account the fact of their directedness not so much by humans, as to humans.

Initially these interventions are supposed to have therapeutic sense: it is waited that in every case such intervention will allow to restore previously disturbed state or function of body or mind. It is obvious that such shift toward human being as a main target of technological and engineering activities generates a lot of ethical problems. Many of them are hotly debated in contemporary bioethics. Roughly speaking, we can understand engineering ethics as a field of enquiry examining first of all problems of safety and security in development and application of new

---

<sup>1</sup> See Yudin, B. Interrelations between Bioethics and Ethics of Biotechnology, in: *Ethics in Biomedical Research: International Perspective* / Ed. by Matti Hayry et al. Rodopi. Amsterdam, New York, 2007. Pp. 125–132.

technologies, social and ecological consequences of their use. These problems take place in outer reality, in world around us. In turn, with development and application of human-directed technologies we enter into our inner world, into the sphere of usually more complex and contradictory ethical problems.

Nowadays the evolution of these human-directed technologies gets one more dimension which is manifest itself in use of engineering and technological activities for purposes of human enhancement rather than therapy. Undoubtedly, in many practical cases it is not so easy to draw distinction between therapy and enhancement<sup>2</sup>. Yet at the levels of motives, expectations and goals of interventions the distinction seems rather appreciable.

There are some areas inside and nearby individual human existence which are the most appropriate for effective application of human-directed technologies. I shall call them boundary, or transitory zones. The simplest example is a zone between human life and death. This zone can be thought of as a span of indefiniteness between two states of an individual human existence: definitely alive and definitely dead. In comparison with both these adjacent spaces the span is extremely thin one, to the extent that in our everyday life we usually take no notice of it. Yet if we, to be armed with means of modern science and technology, will scrutinize this span more intently using large scale, we shall discover many subtle, smallest details and particularities.

One of the well-known objects of study in physical sciences is systems in the state of so called phase transition (say, transition of water into ice and vice versa). Usually phase transition is rather fleeting process, when the system is in unstable state. Essential consequence of such instability is nonlinear dependence between intensity of input actions on the system and its reactions, so that relatively weak actions can cause rather serious effects, bring to cardinal changes of the system. Under condition of such instability some processes running at micro-scales of time and space will result in cardinal changes at macro-level of the system.

---

<sup>2</sup> See, for instance, *Ethics of Human Enhancement: 25 Questions & Answers* / Prepared by F. Allhoff, P. Lin, J. Moor, and J. Weckert for US National Science Foundation. August 31, 2009 <[http://www.humanenhance.com/NSF\\_report.pdf](http://www.humanenhance.com/NSF_report.pdf)>.

In our example, at the level of human organisms micro-interventions are used in order to turn back or at least to slow down the whole process of transition from life to death. And even more, biological engineering performed inside the span between life and death became the source of the whole industry of micro-interventions to be used for various therapeutic (in the field of harvesting and re-use of human organs and tissues, for instance) as well as enhancing goals.

Interventions performed in the transitory zone brings forth, along with physical, biological, technological, engineering problems, also a lot of social, legal and ethical dilemmas. In other words, this boundary zone is fraught not only with promising engineering advances but with attendant and often rather difficult ethical choices<sup>3</sup>.

Mutatis mutandis, similar arguments can be unfolded with regard to other boundary zones of individual human existence, such as zone before birth of a human being, zone between human and animal, zone between human and machine, etc. As a matter of fact, our decisions about moral permissibility or inadmissibility of different interventions in every of these zones represent our pragmatically needed answers on the primary philosophical question: “what is human?” As we can see, human engineering is extremely burdened with ethical choices and deliberations.

---

<sup>3</sup> See Yudin, B. Human being as an object of technological interventions, in: *The Human Being*, 2011, No. 3, Pp. 5–20 [in Russian].



## V. SOCIAL AND POLITICAL PHILOSOPHY

*A. Chumakov*

### **GLOBALIZATION: PERSPECTIVES AND REALITIES OF GLOBAL DEVELOPMENT**

Globalization is as real as sunrise now. It is out of the question that contemporary world has radically changed under the influence of globalization and is facing dangers, which had never existed before. Even mass consciousness, not mentioning the academic community, understands it as an axiom.

It is both good and bad.

It is good because there is no need to prove that what became evident is topical. Thus, we have more opportunities for finding constructive solutions and intelligent practical moves.

It is bad because even serious specialists in global studies begin to see what goes on through the lenses of habit. They, thus, are able to see the situation in one dimension only, from the position of their sustained views. As a result, attention is focused, as a rule, on what is conventional, evident. All other secondary or nascent problems (dangers, obstacles to social development) remain outside the field of view.

For example, there is a common statement that the world community has never been so endangered in its history as now, in the 21<sup>st</sup> century. It is, as a rule, correlated with the threat of nuclear war and environmental disaster. This is right, but the problem cannot be reduced to these issues. The point is not just that we have nuclear weapons, poorly controlled and threatening the humankind with a real possibility

of self-destruction. The increasing human pressure on the environment definitely worsens however tough ecological situation, but it is not the greatest danger.

What is more important now is that humans and their behavior in the global world are not an organic part of this world. In other words, in the last decades the whole complex of global problems has been increased by a new danger, still barely understood – cardinal and rapid change of the architectonics of world interconnections and interrelations. At the same time, the world community demonstrates its inability to react to such changes adequately.

We need a new vision of the world problems and rethinking the priorities of their solutions. It needs to be emphasized that by the end of the 20<sup>th</sup> century globalization has made the world community fully global and that relations, communications and information flows have become cross-border. The humankind has become a holistic system according to all the main parameters of social life. Nation-state (there are about 200 of them now) has ceased to be the only international actor. Numerous multinational corporations, international organizations (including criminal ones, connected with drug trafficking and international terrorism) have also become actors. And this world with numbers of interdependent and confronting actors, like before, is simply spontaneously self-regulated and has no governance that it needs.

The situation is exacerbated by the fact that humans are naturally bio-social beings. They still combine good and bad, kind and evil, love and hatred, peacefulness and aggression. Of course, culture, upbringing and education make people humane and tolerant. But they preserve what is defined by their nature, their biology: aggressiveness, lust for domination, struggle for survival, violent solutions etc.

Like before, these things can be traced in the behavior of separate communities and in the politics of nation-states. Now the whole world community as a holistic system behaves egotistically with the natural environment. The one who does not notice it or pays no attention to it loses firm soil under feet, becomes deluded by abstractions and has no prospects for changes for the better.

It is also important that the number of Earth inhabitants has exceeded 7 billion people and continues to grow. The planetary resources needed to support human lives are, at the same time, limited. They are also unevenly distributed (as well as the population) and some of them are scarce or extinguished. There is overt and covert struggle for the access to natural resources. Most likely, this conflict of interests is going to increase in the future and confrontation is going to become more severe.

As a result, the global world, facing principally new challenges and having no adequate system of governance, fall more and more into the situation of increasing contradictions and uncertainty. We have, in fact, returned to the pre-state condition of “war of everyone against everyone”. Now globalization has made the humankind a single holistic system, and not just separate people and collectives but nation-states and other international actors are involved into this overwhelming confrontation. There is no force to stop them, except self-elimination.

This is the main problem, the main contradiction of our time!

What do we have now? Are there any approaches to the solution of the problem in question? Unfortunately, the problem is not yet fully understood and everyone’s attention is not focused on it, as it should have been. This, there are no practical and visible results. It is enough to say, for example, that now half of planetary citizens live under poverty line on less than two dollars per capita per day.

This state of affairs, in the absence of global ethics, global law and universally recognized human values, drags the world community into the situation of struggle for survival. As a result, most of international contradictions and discussions are resolved by power policy. Power not necessarily is represented by its brutal, rough form. Very often, especially in the economic sphere, coercion is done by soft power. Anyhow, the one who is stronger and more artful, the one having advantages and pursuing uncontrollably selfish interests, wins.

In this international situation, the UN is practically powerless, although seems to be the one to put our hopes on. This organization it was created in the other time and for resolving another issues than governing the global world, such as, first of all, prevention of the new world war and performing regulatory functions worldwide. It would be naïve to think

that the UN reform as such can change something cardinally<sup>1</sup>. At the same time, new attempts to react to serious challenges are made. New global and regional supranational organizations emerge, such as G8, G20, World Trade Organization, World Bank, European Union, Shanghai Organization of Cooperation, etc. But one should not be mesmerized by these structures. They are built to provide cooperative efforts at the global level and they somehow manage to do it. At the same time, these organizations do not solve and are principally unable to solve the main contradiction of our time formulated above.

First, all of them represent only part of humankind, a region or a separated sphere of social activity. Without representing the world as a whole, in all aspects, any governance is doomed to be, at least, limited.

Second, such organizations worldwide are only able, at their best, to perform some regulative functions, being not appropriate for governing world system as a whole.

It is not surprising that nearly all global projects of the last days, of which “peaceful coexistence”, “sustainable development”, “multiculturalism” and some other are the most well-known ones, provide no desirable results or even prove to be invalid. It happens because to realize them successfully we have, as it was mentioned above, no adequate mechanisms.

As a result, the conflict of interest in the global world increases, enforced by growing openness and accessibility of information, which becomes the most important resource and an effective tool for governing social processes, including distant governance. This is why disperse oppositions in various countries act so coordinately and overthrow governments in the course of so-called “colored”, or “Twitter” revolutions.

In this regard, in the global world, the dialog of cultures and civilizations is the only possible way to resolve contradictions in a constructive way and to provide balanced social development both at the national and global levels. But this dialog has its limits defined by the following:

First, approaches based on separate “dialog of cultures” or “dialog of civilizations” are not successful, because they do not reflect genuine (cultural-cum-civilizational) nature of social life, which is a combination of cultural achievements and civilizational relations of society.

---

<sup>1</sup> This topical issue is still widely and seriously discussed.

Second, every culture is initially self-sufficient and wants to preserve its identity. Therefore, constructive dialog based on culture alone is impossible; one should not expect much from intercultural dialog and count on bringing different cultural positions close to each other. At the same time, one should not be over-pessimistic. All dialogs take place not on cultural, but on civilizational foundations. Culture that always expresses individuality and separates the parties involved is the background of such dialog. Civilization is its integrative engine and the more, the higher is the level of civilizational development of the parties.

And the higher is the level of civilizational development of the interacting parties, the more productive this dialog can be. However, the level of civilizational development of various nations and the humanity as a whole still remains at a very low level. Even the academic community does not fully understand that the level of civilization of this or that people (country, collective, individual) is the other side of their cultural development. That is why the policy of multiculturalism, not considering civilizational gap in the development of various cultures, has been, in fact, seriously defeated not only in Europe but in the other countries and regions as well.

One cannot agree with S. Huntington talking about “clash of civilizations”. In fact we deal with confrontation of different “cultural-cum-civilizational” systems (West and East, capitalism and socialism, Islam and Christianity, etc.), where they confront on the basis of cultures but interact on the basis of civilization. This creates multiplicity of cultural-cum-civilizational systems.

Thus, cultural-cum-civilizational dialog implies admitting multipolarity of the contemporary global world. And to make it effective the presence of common civilizational principles of social organization is needed, of which the most important are:

- recognizing and protecting the basic human rights;
- conventional system of ethic norms and values (universal morality);
- single law system (global law);
- religious tolerance and freedom of consciousness.

Responsibility for building such principles and providing conditions for productive dialog in the global world lies, first of all, on the world academic, political and business elites, as well as on nation-states being them largest organized social systems. Level of responsibility of states depends directly on their role in the global system of economic, military, political and cultural relations.

To conclude I would like to stress that the dialog is the only way to overcome any contradictions of the contemporary world. War of everyone against everyone is the only alternative to the dialog, and under the conditions of confronting global interests it would be equal to self-destruction.

*V. Fedotova*

## **GLOBALIZATION AS MEGATREND AND LOCAL MODERNIZATION TRENDS**

As the chair of the section on Philosophy of Globalization, I took part in reviewing the incoming talk proposals. Many of these proposals were characteristically wrong in their choice of section. Many of the prospective speakers were assuming that globalization is identical to global issues, in spite of the availability of a separate section on Environmental Philosophy. It was there that I had to redirect the abstracts of talks on global issues and sustainable development. Globalization is often understood as emergence of a global society, as the making of the universal human culture. All these important issues can be studied in their relation to globalization but not as globalization itself.

The term 'globalization' was initially introduced in the mid 1980s in order to capture the intensification of international relations. Still, no scientific papers treating the problems of globalization appeared before 1990s, because the very process of globalization was still at the budding stage and was aided by information revolution, inter-governmental and non-governmental organizations, and by a number of economic processes as well. The number of books in the Library of Congress whose titles mentioned globalization has been showing a snowballing growth since the beginning of the 1990s<sup>1</sup>.

---

<sup>1</sup> Inozemtsev, V. L. Globalization: Illusions and Reality, in: *Svobodnaya Mysl*. 2000, No. 1, p. 28 [in Russian].

The globalization that began in the 1990s was not the first one. It began at the end of the 19<sup>th</sup> century as free trade, that is to say, as liberalization of commerce, as a free exchange of goods, ideas and people, but it was interrupted by World War I and did not take off again until the beginning of the 1990s.

The globalization that started in the 1990s swept most of the world's nations. The demise of Communism was one of the factors, along with the technological and informational ones. It was an important step forward for globalization, because it eliminated the areas that used to be inaccessible for capital and information. Oddly enough, very few authors comment on the significance of post-Communism in this process<sup>2</sup>.

As a result, a new geographical area was set free for capital, and capital started to be produced there and flew into the area from the outside. Globalization appeared as a victory of economic liberalism, which made the capitalist economic system almost ubiquitous. Export and import tariffs as well as non-monetary trade restrictions were extinguished or cut down and the exchange of goods, assets, ideas, and people was under way. Some emphasis on the mind was made as well, through PR and advertising aimed at promotion of goods within the global economy. The objective properties of goods were augmented by symbols of their recognition which some authors describe as “French bread, Italian fashion, Spanish wine”, etc. So the victor in the global competition is the one who managed not only to produce some unique commodity, or to produce that unique commodity at the lowest cost, but also to secure for it the recognition of its status value.

The term ‘globalization’ was introduced to capture the transnational mode of operation for economy and information, whose expansive growth within the last few decades has enhanced the transparency of national borders for finance-cum-information systems and secured the advantages for those who entered into the technological and information revolution.

U. Beck, a well-known German scholar, wrote: ‘The economy which operates globally tears up the foundations of national economies and nation states. This opens the way to subpoliticization of a completely

---

<sup>2</sup> See Fedotova, V. G. Typology of modernizations and of methods of their investigation, in: *Voprosy Filosofii*, 2000, No. 4 [in Russian].



new scale, and with unpredictable consequences. At stake here is an elegant pushing aside of the old adversary named ‘labor’ during the new round of struggle; but also, and first of all, the simultaneous denouncement of the contract with the ‘ideal collective capitalist’, as Marx called the state; that is to say, doing away with the bonds of labor and state as they developed in 19<sup>th</sup> and 20<sup>th</sup> centuries<sup>3</sup>.

The original interpretation of the role of globalization as an assault on the interests of non-western countries, which is present not only in the works of the mentioned German thinker but also in the works of many other authors, was ‘challenged’ by the success of China, the current champion of globalization. However, globalization does not bring any visible advantages to the periphery countries. It is quite uneven. Many of the UN reports show that globalization creates both growth opportunities and risks of recession as well as that the fourth world countries are growing.

Globalization goes along with the loss of ‘patriotism’ by business and money – with their endeavors to flee to more profitable places. The western states are currently suffering from this trend, too. As for the new capitalist nations in Asia and the post-Communist countries, they could not compete with the champions of global development on the global market were it not for the measures protecting their own interests. The state tries to serve these protection purposes. But the state has lots of enemies at the moment. These are: neoliberalism, which dismisses the economic role of the state; globalization, which weakens the Westphalian system of nation states; capital, which defies the national interests in the name of profit, and the masses who are striving for democracy.

I cannot agree with those who see globalization as a continuation of modernization. Quite the contrary is often the case. Global economy is a club of the countries that are already modernized. According to a point of view which used to prevail for a long time, the non-western countries following the catch-up (to the West) modernization model sought to copy the western institutional systems. Now it turns out that

---

<sup>3</sup> Beck, U. *Macht und Gegenmacht im Globalen Zeitalter*. Neue Weltpolitische Ökonomie. Frankfurt am Main: Suhrkamp, 2002, S. 5 (our translation may differ from the one in the English version of the book).

not every country can do this, and Russia failed to do this in the 1990s, while China is neither going to nor can do this. Everywhere, the essence of the catch-up modernization process is the same: it is the organization of masses for the industrialization<sup>4</sup>. This common aspiration to catch up with the West turned modernization into a megatrend, which was setting the goal of development in the direction opened up by the West without taking the local cultures into account. But this was only possible before the advent of globalization. Globalization, seen as a new type of social transformation in its institutional and value dimensions prevents the countries that are going through modernization, Russia in particular, from merely copying and simulating the existing structures of western society; these structures are now undergoing changes themselves. Nowadays, modernization is still under way in many countries, but its character is different now. It takes into consideration the local cultures and assumes some distinctively national features. It has turned into a plurality of local trends associated with the globalization megatrend.

Thus, the term ‘globalization’ was introduced very recently in order to capture the new process of social transformation. The emergence of globalization in the real world is the consummation of the formation process of global relations, free trade, and the making of the universal history which comprised the essence of a quicentenary development of the West, and of the world in general, that both aspire to making progress and to achieving modernization<sup>5</sup>. Currently, these processes are pushed aside, into the periphery countries and down to the level of local development, where one finds a richer selection of modernization models which attends not only to the solution of inner problems, but also to identification of one’s own place within the global world and the global economy.

---

<sup>4</sup> Vysheslavtsev, B. P. Crisis of industrial culture, in: *Marxism. Neosocialism. Neoliberalism*. New York, 1982, p. 15.

<sup>5</sup> Fedotova, V. G., Kolpakov, V. A., Fedotova, N. N. *Global Capitalism: Three Great Transformations. Social-Philosophical Analysis of Relationship between Economy and Society*. Moscow, Kulturnaya Revolutsia Publishing House, 2008 [in Russian].

## **GENDER ASPECTS OF THE MODERN LEFT-WING POLITICS: THE SPECIFICS OF RUSSIA**

Different political forces, directions and associations, as a rule, have their own response to the question of the place of women and minorities in the society in general and in politics in particular. This attitude is quite obvious when you try to compare different variants of the conservative ideology – with its so called natural hierarchy of society – and, on the contrary, the socialists, the left direction of the political theory and practice, with their emphasis on equality.

This paper is dedicated to the present situation, in Russia especially, and we'll point some historical aspects out at first.

Despite the fact that the history of the equality of rights dates back to the period of the Enlightenment and it is associated with the liberal idea, the social and political practice of the struggle for women's rights is related to the early socialist movement in Europe in the end of the 19<sup>th</sup> – the beginning of the 20<sup>th</sup> century. The ties between the feminists and the left have the long history. By the beginning of the 19<sup>th</sup> century the development of feminist theories was particularly based on the philosophical concepts of socialist utopianism of Saint-Simone, Fourier and Owen. (By the way, it was Fourier who in fact invented the term feminism). So these thinkers and their followers were concerned about the place of women: in their opinion, the equality of women and men couldn't be reached within the present social system and it was possible after the radical changes, including the cancellation of private property.

These ideas had not gained major popularity in their time. High society appreciated liberal ideas much more, lower classes in general supported the traditional androcentric system, with a man as a bread-earner, a provider, and a woman as a housewife and a mother, deprived of political rights.

The new impulse for the further interaction between socialism and feminism gave the ideas of Marx and Engels, who paid significant attention on the problem of women's labor, and the idea of repression of women (along the thesis about the repression of proletariat, certainly) is an important idea of the later Marxism. In 1910 at the International socialist conference in Copenhagen the appeal for the solidarity of women in the striving for social and political equality, and it was the followers of Marx and his philosophical concept who offered that.

The second spree of feminism in Europe in the 1960s was a kind of the reaction to the impetuous rise of radical left movement. The general demand of the feminist in this historical period is not the right to elect only (it was more or less reached by then) but to be elected also, to politicize actively. It's quite important to mention that the question of women's rights has slightly lost importance for the modern European left politicians, it's not in the centre of the agenda anymore, but it's not because of a kind of a switch in the ideological position, but thanks to the united attempts of the left and the liberals. The problem itself has lost some of its acuteness, the social and political place of men and women in the so called Western world has become much closer than it had used to be.

Discussing the gender stereotypes of the modern left politics, we should mention the LGBT problem, as far as we can talk about the LGBT as a community, because this abbreviation means the vast diversity of not social groups only, but different separated persons. So it's quite conventional. Nevertheless, the discussion on the place of the minorities within the left movement stays an actual one for the several last decades. Starting from the initiatives of Carl Henrich Ulrichs and Magnus Hirschfeld, who relied on the ideological support of the left, the last ones had to form the position on this question out. It is known, that Ulrichs's position wasn't approved by Marx and his comrade Engels. And we can see the very different situation in the XX century, in its

second half especially. Year 1968 of the so called student revolution is associated with the left proclamations of the struggle for the rights of the minorities, and this struggle, as it is seen nowadays, turned out to be quite successful.

Comparing to the rather problematic, difficult but doubtless gains of equality in the most of European countries Russia has its specifics. While in the USSR the social and cultural system supposed the almost radical feminism (a woman was an equal comrade, in the official political rhetoric) the place of homosexual citizens of the USSR was a pitiful one, and frankly speaking, dangerous because of the sanctions for such a practice – imprisonment, precisely. The criminal prosecution, cancelled by the Bolsheviks after the October revolution, was returned later, in the period when Josef Stalin was the head of the state. When the vast social reforms in Europe were held in the 1960s, and they covered the decriminalization of homosexuality in particular, there was nothing like that in Russia till the beginning of the 1990's, when the corresponding part was excluded from the penal code. It had been done on behalf of the anticommunist politicians, we should mention. Since then the left in Russia face the problem, how to evaluate the gender aspect of their own policy. Here's the significant difference with their western colleagues.

What do we see today? The left political movement in Russia is quite obviously divided into two different, hardly interacting parts. The old left, who in general maintain the traditional soviet values, and the new left of the European type. The official left wing of the Russian politics is not a big threat for the state regime, and such parties as the Communist party of Russian Federation (CPRF) and "Spravedlivaya Rossia" ("Just Russia") feel quite safe, as they are represented in the Parliament (the Duma), and supporting the state power in many important questions. Moreover, CPRF, that calls itself a left party, is not that in our opinion. Its obvious ideological support of the army, of the church and the other disciplinary or suppressive institutions of the conservative state, as well as the transparent approval of Stalinism. The party program contains no mention of its intentions to overcome the discrimination of women and minorities in Russia. The SR at least states in its program that a woman's role as a mother shouldn't be the reason of social discrimination. Men and women should be equal in family life, at work and

in society in general, that's the statement. But that's all about gender problems in the party program documents, moreover, SR members in the State Duma voted for the so called law against homosexual propaganda this year. This law prohibits to hold public actions against human rights violation in Russia, actually, so this law in fact contradicts the Constitution.

But there are some alternative political organizations in modern Russia, whom we call the left more definitely. They are minor non-registered parties, even civic movements only, but they are quite interesting to analyze the tendencies. They particularly take their ideas from the Mensheviks, the liberal left of the first quarter of the XX century in Russia, partly gravitate toward the original Marxism, and they are also close to the European left of the 1960s – 1970s, who were influenced by the philosophy of the Freudo-Marxism. One of these organizations is the Left Socialist Action, members of which call themselves social democrats. The LSA claims that they struggle for the real equality of men and women, including the proportional presence in the power organizations and institutions. By the way, quantity of women in the population of Russia is more than of the men, but their presence in politics, state management etc. is rather low nowadays. These new Russian left declare about their position on the LGBT problem, and this position is against the discrimination of this social group. In the party manifesto we can read the following: “controlling the human sexuality always has been one of the ways which the state power chose to suppress and to exploit the citizens. A human being has the right to love no matter what the sex of his partner is”<sup>1</sup>. This point of view is obviously marginal for the politics in modern Russia. But it's closer to normal within the theory and practice of Socialism in many countries, mainly European.

The Russian section of the international organization Committee for a Workers' International (it's a more radical left organization, they are even called the Trotskyists) also criticize the Russian regime for the discrimination of women. Women in modern Russia have worse labor opportunities comparing to men, their salaries less for the same job, and the public moral still dictates them to be also mothers and housewives in the most traditional way, together with their work. So the CWI calls for the political struggle against this very unfair situation. As for the prob-

---

<sup>1</sup> See: [http://levsd.ru/?page\\_id=6](http://levsd.ru/?page_id=6).

lem of the LGBT, the CWI reminds that the Soviet Russia became one of the first countries that abolished the criminal penalty for homosexuality, and it was returned later, in Stalin days. The CWI in Russia claims that the LGBT are the same citizens like any other, they work, pay taxes etc., and the discrimination at work, in public activities, in family life is unfair<sup>2</sup>. The alternative left suppose that it's not a problem of a social group, a minor group, but it's a signal for the society in general which shows the imbalance, the lack of consent, and it can be solved together with the overcoming of poverty, totalitarianism in politics, clericalism, which is obviously increasing in Russia nowadays.

So, to make the long story short. If we take the policy of equality and social justice, which have always been and remain the most important characteristic of the political left, there are pseudo-left political forces in Russia, that are loyal to the conservative official state power, and the new left, who represent the international tendencies of the development of the left idea, and they consistently oppose the state power, including the questions of the gender.

As the famous French philosopher Michel Foucault mentioned in his famous book “The Will to Knowledge”, in the époque of the bourgeois order sexuality as is and the knowledge and the speaking about it, which means the discourse of the sexuality, turn out to be the part of some political action<sup>3</sup>. While Russia is building its own bourgeois order, we can see the fairness of this Foucault's statement. While the state approves the obligatory heterosexuality for all the citizens, not openly, but in fact it is so, the alternative ways necessarily become politically opposing. “Today... the struggle for Eros is a political struggle” Herbert Markuse said in his time, and these words sound very modern, very up to date in today's Russia<sup>4</sup>. And as Foucault mentioned, if sex is suppressed and doomed to the silence and inexistence, the very speaking of it is a courageous overcoming and a hint of a future liberty<sup>5</sup>. In these conditions

---

<sup>2</sup> See: <http://socialistworld.ru/manifesto>.

<sup>3</sup> Foucault, M. *The Will to Truth: On the Other Side of Knowledge, Power and Sexuality. Miscellaneous Works*. Moscow, Castal, 1996, p. 107 [in Russian].

<sup>4</sup> Marcuse, H. *Eros and Civilisation. One-Dimensional Man: A Study of Ideology of the Developed Industrial Society*. Moscow, AST, 2002 <[http://www.gumer.info/bogoslov\\_Buks/Philos/Mark/12.php](http://www.gumer.info/bogoslov_Buks/Philos/Mark/12.php)> [in Russian].

<sup>5</sup> Foucault, M. *The Will to Truth: On the Other Side of Knowledge, Power and Sexuality. Miscellaneous Works*. Moscow, Castal, 1996, p. 103 [in Russian].

women and the LGBT in Russia sacrifice one of the most important gains of modernity – the privacy – in order to gain another goal of it, which is human rights and social justice.

That's why the feminists and the LGBT in Russia are not just social or the so called sexual minorities, but they are the part of the political opposition, just like the new left, like it used to be in Europe in the 1960 and 1970s. By the way, today the conservative power in Russia lacks its own ideology in a way, taking some ideas from the Soviet political myths, some even from the pre-Revolutional Czarist Russia. This conflict can become one of the future tendencies in the Russian political sphere – not a major one probably, but quite significant and promising.

So which year will become the year 1968 for Russia – it's still a question to discuss in 2013<sup>th</sup>.



## THE PROBLEM OF THE DIVISION OF LABOUR IN THE CONTEXT OF PHILOSOPHY OF ACTIVITY/TÄTIGKEIT

### Division of labour phenomenon in broad sense is widely know and stated in sources for ages

The term of the Division of labour in the broad sense is widely known and stated in sources for ages. For example, in the popular anthology *Readings in the Economics of the Division of Labour: The Classical Tradition* (2005)<sup>1</sup> edited by Guang-Zhen Sun we found some quotes from Xenophon, Plato, Aristotle, Ibn Khaldūn. This is a strong argument for us to consider that phenomenon's active discussion was both in ancient and medieval sources.

As it is known, Adam Smith and his predecessors in 17–18 centuries: A. Serra, 1613, W. Petty, 1671, D. North, 1691, Martyn, 1701, B. Mandeville, 1720<sup>2</sup>, E.L. Carl, 1722, P. Lindsay, 1733<sup>3</sup>, R. Campbell, 1747<sup>4</sup>, F. Hutcheson, 1755<sup>5</sup>, J. Tucker 1755<sup>6</sup>, J. Harris, 1757<sup>7</sup>, A. Ferguson, 1767<sup>8</sup>, Turgot, 1770 – all of them attached importance to the fundamental sense of division of labour processes in the case of productivity enhancement, increase of labour efficiency and wealth of nations.

<sup>1</sup> Sun, G.-Zh. *Readings in the Economics of the Division of labour The Classical Tradition*. Singapore, World Scientific Publishing Company, 2005.

<sup>2</sup> Mandeville, B. de. *The Fable of the Bees*. London, A. Roberts, 1729.

<sup>3</sup> Lindsa, P. *The Interest of Scotland Considered*. Edinburgh, R. Fleming & Co., 1733.

<sup>4</sup> Campbell, R. *The London Tradesman*. London, 1747.

<sup>5</sup> Hutcheson, F. *A System of Moral Philosophy*. Glasgow, 1755.

<sup>6</sup> Tucker, J. *The Elements of Commerce and the Theory of Taxes*. London, 1755.

<sup>7</sup> Harris, J. *An Essay Upon Money and Coins*. Part I. London, G. Hawkins, 1757.

<sup>8</sup> Ferguson, A. *Manual of Political Economy*. Edinburgh, 1767.

Reflection on the experience of historical development of human activity allowed to make the difference between the “native” and the “artificial” (that is, “technological”) DL from the 18<sup>th</sup> century. Historians and ethnographers maintained that the traces of “native” division of labour can be detected in any human society from the very beginning of human history: above all in its sex-, age- and territory-dependent forms. The influence of “native” division of labour on the building of fundamental economical institutes – such as trade, money, credit – was described in many works.

Well known example of division of labour into 18 operations in pin-making business is the fundament for the 1<sup>st</sup> chapter of Adam Smith’s *The Wealth of Nations* (1767) and its empirical part almost entirely repeats the article «Pin» from *Encyclopédie* (1751) Diderot and D’Alembert.

At the same time, “technological” division of labour has a very long history as well. An example of such division was described by Thor Heyerdahl in his book “*Aku-Aku: The Secret of Easter Island*” (1957) – this example describes the installation of a rock statue by a group of aborigines of the Easter Island. It is also evident that the Pyramids of Egypt can be built only with a very elaborate and differentiated division of complex labour operations into more simple, performed by different agents of the production process, and without “assembly” of these simple operations into chains and complexes of activities.

Many researchers in 19 century also pay attention and work on advanced study of the division of labour phenomenon, but economists in 20<sup>th</sup> century generally tired of it. Those problems, which traditionally refer to division of labour phenomenon in broad sense, are usually described as technical and empirical – mostly as a part of engineering and factory management or as a subjects matter of sociology, psychology and anthropology. In particular, Lionel Robbins notes this fact in his *An Essay on the Nature and Significance of Economic* (1932).

This process was carried out and analyzed at certain enterprises by engineers and production managers, classics of industrial engineering (IE for short); IE was described perfectly in Henry Ford’s works with the

example of creation the automobile “assembly line”<sup>9</sup>. In economical thought, on the contrary, in spite of acknowledging the important influence of division of labour on the labour productivity and wealth, the division of labour system (DLS for short) is look like a kind of “black box”, which internal structure is never become a subject of the economics itself. May be said that due to its original practical “simplicity”, the true scientific and philosophical interest for the DL processes paled into insignificance in the 20<sup>th</sup> century.

**Amount of this term and sphere of these phenomena contrasts sharply with the priority and level of its theoretic comprehension/ conceptualization**

At the same time, we should recognize that the importance of this term and sphere of these phenomena stands in stark contrast with the level of its theoretic comprehension/conceptualization.

There is terminological confusion with the phenomenon of «specialization» for the entry «division of labour» in the one of the most relevant economics encyclopedia *New Palgrave's Dictionary of Economics*, 2008 (edited by Peter Groenewegen). Herein «division of labour» is described both as a synonym, as a special case and a pre-requisite for specialization<sup>10</sup>.

We have found 3 different species of division of labour in the entry:

- social division of labour;
- division of work inside factory walls;
- manufacturing division of labour.

---

<sup>9</sup> Ford, H., Crowther, S. *My Life and Work*. (Garden City, New York, USA: Garden City Publishing Company, 1922); Ford, H.; Crowther, S. *Today and Tomorrow*. Garden City, New York, USA: Doubleday, Page & Company. Co-edition, 1926, London, William Heinemann.

<sup>10</sup> Groenewegen, P. Division of labour, in: *The New Palgrave Dictionary of Economics*. Second ed. / Eds. Steven, N. Durlauf and Lawrence, E. Blume. Palgrave Macmillan, 2008; *The New Palgrave Dictionary of Economics Online*. Palgrave Macmillan. 27 April 2013 <[http://82.179.249.32:2288/article?id=pde2008\\_D000176](http://82.179.249.32:2288/article?id=pde2008_D000176)> doi:10.1057/9780230226203.0401.

In other sources you can find a difference between «horizontal» and «vertical» divisions of labour, opposition between «native» (sex-age structure, territorial) and «artificial» (technologic) divisions of labour, discussion on wide area of problems of division of activity / tätigkeit (inter alia, an operationalization of labour, a division of tasks, activities, a separation and distribution of powers), an economy of scale.

Starting from Marx, leastwise, the topic of division of labour and activity / tätigkeit is quite naturally refers to necessity/requirement of following unionization of those activities into whole new entity – coordination, cooperation, communication, organization and management, etc.

### The schematization of sense field

Let's try to schematize this sense field to facilitate further research.

In such case as the division of labour / division and co-organization of work in a separate enterprise is in a center of the consideration, like it was in the works written by Ford in early 20<sup>th</sup> century, we will get at least 4 groups of different processes (effects).

They associate with each other and combine in a single field of division of labour in the broad sense of the word, acting as factors which could stimulate or limit the division of labour in the narrow sense of the word (as the division of works or activity in a particular enterprise).

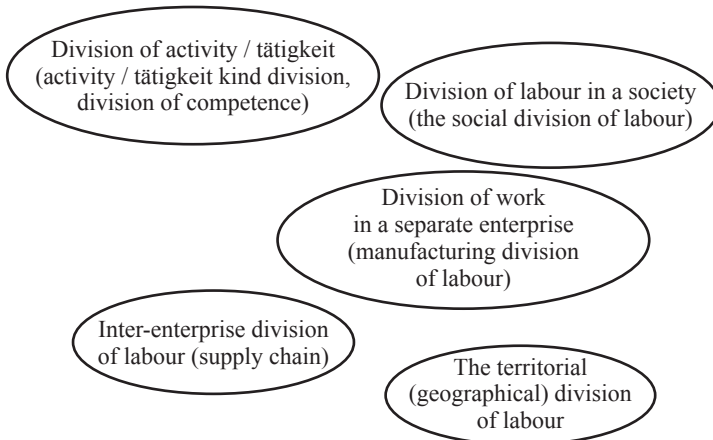

## **«Division» of activity / tätigkeit and thinking.**

At the same time another dimension of the process of DLS creation is always present. Let's call it "vertical". In this dimension the work on designing of systems of activities concerning the creation of product, including the process of designing and re-designing this product. The more complex the product is, the more complex the vertical dimension will be. Nowadays it will necessarily include the processes of research, design, creating of production system, system of logistics and activity management. Just a few hundreds of people work at the assembly plant of the "Boeing" corporation in Seattle. But the system of creation of modern aircraft and all the more of the aircraft of the future requires the work of hundreds of thousands of specialists, scattered over the globe and involved in dozens of related sectors.

When we speak about any complex project, we might say that it's constructed from the activities oriented towards its creation. Modern composite aircraft is built from different activities than the one that we traveled by 30 years ago. The DLS that is needed to create a modern aircraft, consisting 70 % of composite materials and created due to module assembly, is radically different from the DLS that has existed just a while ago.

In order to perfect his "assembly line" Henry Ford was purposely involving his workers in this process, creating "circles of quality" at the factory. The project-making and new DLS-growing system in the new economic sectors now involves thousands of specialists – from the participants of fundamental sciences of materials research to the specialists in psychology, from the designers to the specialists in digital models.

Here we should stress that the construction of modern DLS is not only a question of engineering and management. The development of DLS is impossible without comparing the "effectiveness" of different combinations of production factors; this "computation" in the real situation is made by hundreds and thousands of businessmen on the basis of market-prices; which means that the "vertical" involves systems of management account and financial markets, on the foundation of which the configuration of DLS is being developed.

In different periods of time each factor and/or its connections went through detail examination and study by different authors for the last time.

At the same time, we would like to emphasize the one of the mentioned factors. In our opinion, it rarely (or even never) becomes a subject matter of special theoretic analysis and in-depth philosophical analysis. The issue is about «division» of activity / *tätigkeit* and thinking.

Obviously in any case of organization of work «here and now» in a separate enterprise you should decide preliminary and in parallel a question of the activity's description and objectification, which must be divided in future into its constituent parts, for example, operations and procedures. It also matters for all practical problems and cases of division of work in a separate enterprise (as H. Ford tackled a problem).

Such objectification – the description of workman's activities, externalization of the “hidden” premises of that activities and operations (including actions in the mind or imagination, so-called thinking actions or intellectual operations in the psychology) – is a condition for building the supply chain of a complex product and involving useable for production process machines and mechanisms.

F. Taylor – as one of the predecessors of revolution in management and the author of so-termed Scientific management – has devoted much time to study psycho physiologic characteristics of human motions and its locomotor system. The aim was to create the techniques of work organization and tools usage, which would be adequate for objectifying representations of human motion and action.

### **The schematization of sense field**

It is the division of activity / *tätigkeit* – unlike the other aspects of the processes of division of labour – that very rarely becomes the subject of a special study. This can be explained by the fact that the researchers have focused primarily on the problems of division, differentiation and specialization of labour, rather than on the processes of co-operation and co-organization.

But the problem is significant. We need a vision of the whole activity / tätigkeit to join different parts of divided activity into the wholeness.

L. Mumford<sup>11</sup> in analysis of the history of ancient civilizations introduced a special term: he named this wholeness “megamachine” of activity / tätigkeit.

We suppose that the theory of activity / tätigkeit is usable as a basis for the philosophy of division of labour. It is viable because of the significance of constructing the wholeness of activity / tätigkeit.

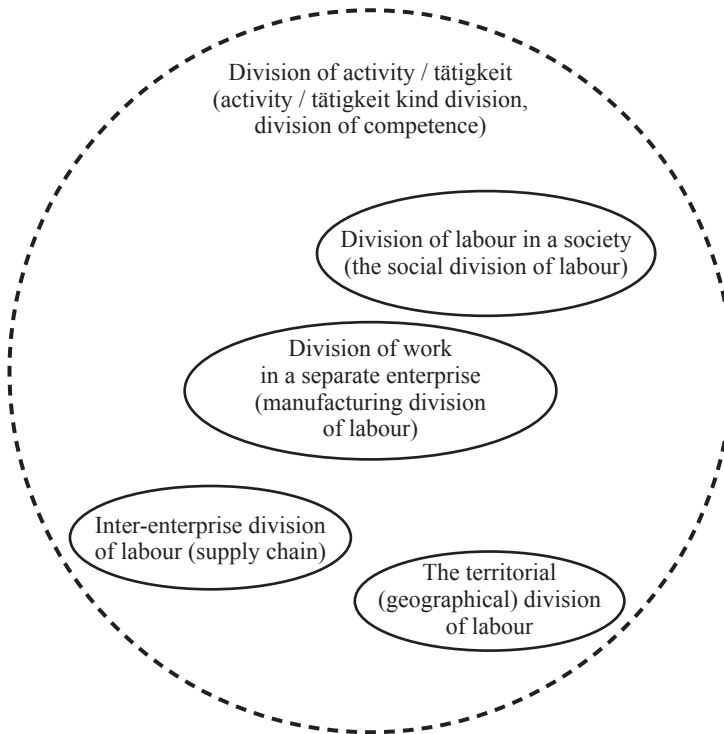

---

<sup>11</sup> Mumford, L. *The Myth of the Machine*. 1970.

## **Division of labour goes from simple forms material and practical activities to complex forms, which includes a substantial part of intellectual operations**

At the same time, the changes that started in the second half of the 20<sup>th</sup> century (and especially during the last 15–20 years) force us to return to the philosophical consideration of the “division of labour”. The technological platform of contemporary industry changes essentially: most of every simple and part of complex operations are performed by the machines, automats, robots. The package of new innovational decisions and technologies (first of all, digitalization, new materials and intelligent smart systems) are taking form today. The character of labour, which has specific for the creation and exploitation of contemporary big technical systems, changes today – it becomes more and more intellectual.

The second half of the 20<sup>th</sup> century brought us one another important change. The process of division of labour actively began to “capture” those kinds and types of activity, which weren’t the object of technification and creation of new DLS 50 years ago.

Division of labour’ processes go from simple forms material and practical activities to complex forms, including a substantial part of intellectual operations, like research activity / tätigkeit, construct works, engineering, logistics, management.

It is precisely that in these fields there is a powerful process, which we can metaphorically name the new taylorization of intellectual labour. And the product of it is an intellectual “mega machines”.

This process is often described in social and psychological reality as a formation and complexification of social networks and other forms of network interactions. It is true. However, there is designing and entrepreneur’s estimation of the more and more complex intellectual «supply-chain» at the basis of these changes.

It is common sense today that the problem of the division of labour arises everywhere; intellectual «conveyors» come into existence all over the place; today in many different fields and areas of practice there is an active work on the objectification and an operational representation (description) of complex forms of thought-activity.



Earlier division of labor was led by managers of production for simple kinds of activity, using the notions of common sense and the trial-and-error method. Today this way of work of description, operationalization and co-organization doesn't longer satisfy us, when we are dealing with intellectual processes. For designing and making technology we will have to extend considerably our notions about activity and thinking, completing philosophical ontology with the whole set of applied research and project-construction designs.

In other words, today the further deepening of processes in the case of division of labour in intellectual types and fields of activity / *tätigkeit* faces with the lack of scientific and theoretical knowledge and understanding of human thinking and activity / *tätigkeit*. And this lack is caused by deficiency of proper philosophical, ontological conceptions of activity / *tätigkeit* and thinking (thought-activity).

These conceptions have been actively developed in philosophy since the beginning of the 20<sup>th</sup> century.

The development of those has seriously influenced different areas of humanities and social sciences

We would like to emphasize that in late 19<sup>th</sup> – early 20<sup>th</sup> century the necessity of developing of philosophical and theoretical concepts of the activity / *tätigkeit* and thought-activity was fully discussed and proclaimed by different schools. Among others there are 2 major schools, which declare respective programs in this subject matter – from one hand, Marxism, from the other, Austrian School.

There are common philosophical conceptions on “activity” in the works of K. Marx on the one hand, and in the works of so-called Austrian school of economics on the other hand. These conceptions were used to improve understanding and interpreting phenomena of household, market, exchange and entrepreneurship. Ludwig von Mises in his famous work “Human Action” (1949) claimed, it is “praxeology” or “common theory of action” that economics as a type of knowledge is based on.

These schools have strong opposition in their value systems, but they both recognize that the ontology/theory of activity / *tätigkeit* (or praxeology) is fundament for economics and management science.

However, these value systems' differences decline to connect 1) objective representations of historical processes of development activity / tätigkeit and thinking, according to Marxist methodology, and 2) subjective representations of aimed human activity (thought-activity), developed by sociologic and physiologic disciplines and Austrian school of social sciences.

However, later on, the methodological and philosophical research has not acquired necessary development in the area of "theory of action" as a fundamental basis for interpretation of economical phenomenology. It can be explained by strictly social reasons: the sharp debate on the value framework of economical knowledge has expanded between Austrian school on the one hand and Marxists on the other. We can speak about the gap between German and English traditions of considering the "activity" a subject of philosophical and socio-humanist knowledge: the term "activity" used in English language from the very beginning couldn't express the meanings that were developed by German classical philosophy.

As a result, there are two aspects of interpretation of activity – 1) the objectified interpretation, developed by Marxism and also used in the conceptions which originated from Marxism and considered activity a cultural and historical process of reproduction on the basis of transmission of norms and socialized means, and 2) the subjectified interpretation, developed in sociology, psychology and economics in the form of different theories of activity, which describes the consumer's and entrepreneur's behaviour using the terms of value, consciousness, effort and will. This gap between two interpretations exists today. This gap doesn't let economics to solve (and even to state correctly) the problem of correlation between the objective value (cost) and the subjective. Also it denies to reconcile teleological and causal approaches towards the explanation of the economic phenomena.

In other words, one of the most important trends of the development of economic notions lies in the field of philosophy, regarding the growth of their explanatory power, as well as in respect of systematization of accumulated models of different scales: it needs the development of ontological concepts on Activity and Thought (Thought-Activity), meaning the history of complication of strictly philosophical ideas in this field in the second half of the 20<sup>th</sup> century.

## THE REVOLUTION OF SPIRIT AS A CATEGORY OF PHILOSOPHY OF HISTORY

The central category of Marxist philosophy of history – the revolution of spirit – is considered in my paper mainly in connection with the contribution made by Karl Kantor, a well-known Russian philosopher, into solving the problem. I refer to his fundamental work titled “A Double Spiral of History. Historiosophia of Projectism”<sup>1</sup>. The revolution of spirit is central to the author’s conception.

What do we mean by ‘spirit’? The spirit is an absolute entity, absolute utmost perfection. At the same time man’s spirit means burning fire, a desire for complete reconstruction of man’s life and society. The man’s spirit is revolutionary by nature. Three revolutions of spirit which occurred in the history of mankind correspond to three paradigmatic projects of history.

The first revolution of spirit was the phenomenon of Christ and the first project of history became Christianity. The second revolution of spirit was Renaissance and the second project of history was an aesthetical, art project. Only this time the realm of freedom has extended and covered all aspects of individual human life, freedom has become universal. The third revolution of spirit was performed by K. Marx and his scientific project of history, historical development of society, which synthesizes, absorbs the religious and the aesthetical projects.

---

<sup>1</sup> Kantor, K. *Double spiral of history. Historiosophy of projectism*. Moscow, Languages of the Slavic culture, 2002 (transl. from Russian) [in Russian].

Each of those three revolutions of spirit lasts over long periods of time. Each revolution has its prophets and apostles, saints and martyrs.

The basic component of Karl Kantors's conception is the notion of sociocultural evolution (I have to simplify his point of view because of the lack of space), which is different from the notion of history. According to Karl Kantor, the idea of sociocultural evolution gives a deep insight into the philosophy of history developed by Karl Marx.

I agree that the problem of constant uncompromising struggle between history and sociocultural evolution is the central issue of Marx's philosophy of history. The revolutionary spirit aims at the radical change of man by means of radical change of social institutions, peoples' ways of everyday life and activities. However, the attempts of radical change of man give rise to problems and challenges which, in their turn, create the situation when the spirit ceases to be a revolutionary idea and gradually becomes a dominant ideology of social strata or classes which took the power. The course of events brings about the crisis of history. Sociocultural evolution eventually brings society to the deadlock. A way out of the deadlock is inevitably connected with the beginning of a new stage of revolution of spirit.

In the beginning of the 20<sup>th</sup> century for the first time in the world's history, revolutionary spirit receives the real opportunity to change a course of history. It was the October Revolution. The revolution of spirit in Russia in particular had its apostles. Vladimir Mayakovsky, a well-known Russian and Soviet poet long before the revolution called himself a thirteenth apostle. Young V. Mayakovsky was convinced that there is a strong deep bond between the ideas of Christ and Marx. K. Kantor writes about these moments in a very interesting and questionable work, dedicated to the works by V. Mayakovsky.<sup>2</sup>

In the futurist paper "the Futurist Gazette" V. Mayakovsky wrote in 1918 together with D. Burluck and V. Kamensky, who also belonged to the futurist group: "The Revolution of February (which preceded the October Revolution in 1917) has abolished the political slavery. The

---

<sup>2</sup> Kantor, K. *The thirteenth apostle*. Moscow, Progress-Tradition, 2008 (transl. from Russian) [in Russian].

October Revolution threw a bomb of social revolution at capital. We – proletarians of art call the proletarians of factories and land to the third bloodless but severe revolution, the Revolution of Spirit”.<sup>3</sup>

The drama of the recent history in Russia is caused by the struggle between history and the sociocultural evolution of society. Being originally behind the West in its economic development, and dependent on the West at that, Russia pushed to the forefront and won the leading role in history, started a transformation of Russian society on the spiritual basis.

Thus history appeared to be far ahead of the sociocultural level of development of society. Before it happened, many writers and poets predicted a possibility of immediate, quick transformation, which involves masses of uneducated people. In actual history, however, the transformation turned out to follow a different scenario.

In actual life there was a clash of the revolutionary idealism of spirit with the reality of everyday life, which produced the drama of their relations known from the world history starting from Christ and still going on at present. V. Mezhuev notes, that «K. Marx was a critic of any society not only a capitalist one, when society strives to stop a current of history, becomes a barrier, a dam on the road of history. <...> The enormous efforts are required up to the revolutionary ones that break from one society to another».<sup>4</sup>

What happened in Russia was bound to happen. It was the victory of sociocultural development of society over history. Mayakovsky’s death was fatal because he was an apostle, like the first apostles of Christianity who were persecuted. What caused the poet’s tragic death? It was impossibility to preserve his faith of the apostle in new conditions, the impossibility to make creative verse change the consciousness of man and induce him to social creativity, to a permanent transformation of social life and society, to the creativity in all its manifestation.

Here a question arises: is it tenable for the revolution of spirit to continue or not? It is a very complex question.

---

<sup>3</sup> *Newspaper of the futurists*. Moscow, March 1918, No.1 (transl. from Russian) [in Russian].

<sup>4</sup> Mezhuev, V. Idea of the world history in the theory of Karl Marx, in: *Logos*, 2011, No. 2, p. 22 (transl. from Russian) [in Russian].

The crisis of contemporary civilization consists in the fact that there doesn't exist a new modern project of history, an insight into mankind's future. This is the deepest crisis of history. The struggle against the development of history carried out by the most powerful state today is actually the fight against any attempt to renew or, moreover, start a new stage in Marx's revolution of spirit.

The process of sociological, sociocultural transformation of Marxism took place over the 20<sup>th</sup> century. Marxism has become chiefly sociological teaching. By way of illustration D. Bensaid, a French Marxist philosopher, the theorist of Revolutionary Communist League, claimed: the ghost of Communism is back, that's why the spirit of revolt is going back, and that's why Marx is our contemporary, Marx is still relevant for the history. Being very optimistic about the future of Marxism, D. Bensaid conceded notwithstanding that «the future is provided only in case Marxism is not hidden behind the University wall. Contrariwise, Marxism should have close bonds with the renewed practices of modern social movements and with anti-imperial, anti-globalization movement»<sup>5</sup>.

Here I would like to make reference to Slavoj Žižek, a well-known postmarxist Slovenian philosopher, an idol of leftist youth, who expressed full agreement with the words of an author which run as follows: «How to achieve such a situation, when your consciousness does not coincide with the spirit of capitalism»<sup>6</sup>. In one of his interviews S. Žižek speak about a radical new situation in modern left movement. S. Žižek proposes to return to a tragic sight of social process by Hegel. Then a hidden teleology doesn't lead us. Thesis by Slavoj Žižek: “signs from communist future are not constitutive, but regulative” seems to be very bold and innovatory, but many questions provoke. In particularly, how can we relate this thesis to K. Marx's point of view on the revolution of spirit?<sup>7</sup>

---

<sup>5</sup> Bensaid, D. *Marx. The manual*. Moscow, Institute for all humanities studies, 2012, p.179 (transl. from Russian) [in Russian].

<sup>6</sup> Žižek, S. *Speculations in red: the Communist view on the crisis and the accompanying things*. Moscow, Europe, 2011, p. 271 (transl. from Russian) [in Russian].

<sup>7</sup> Žižek, S. *Postscriptum to the Russian travel of the philosopher*. Interview for COLTA.RU, [www.colta.ru/docs/5216](http://www.colta.ru/docs/5216) (transl. from Russian) [in Russian].

What are the prospects for the present-day Russia? In 1917 Marx replaced Christ in Russia. We still have to think well before we say that Christ has returned in Russia, but we can say right away that K. Marx has definitely left Russia.

Today in the Russian society one can hear a lot about the revival of spiritual life, but what is meant is the return of Christianity in the Russian Orthodox version. As far as secular spiritual life is concerned we are still in need of a clear modern conception of spirit. As we haven't found it yet, it is not likely to be found unless we return to the true meaning of Marx's philosophy.

K. Marx's idea of history was the idea of replacing exploitation and alienation of labor by freedom and creativity, when freedom and creativity of individual development provide the development of all. However, our main concern today is not what K. Marx wrote about alienation. The main issue is whether we could return now in the 21st century to the spiritual meaning of Marx's philosophy, to the spirit which brings about the ever-burning fire of transformation of contemporary history and man. Then we might expect new prophets and apostles to appear, like Vladimir Mayakovsky, who considered himself an apostle, to be one before the Revolution of 1917.

V. Mayakovsky returned to the Soviet society immediately after Stalin's death. In the summer of 1958. V. Mayakovsky's monument was created in Moscow. However at the close of the 60s, especially after the end of Khrushchev's "thaw" V. Mayakovsky was again pushed to the periphery of the country's cultural life.

There is no place for V. Mayakovsky in the present day post-Soviet society. Few people remember Mayakovsky's words about the necessity of the third revolution of spirit in the then new Soviet society which I mentioned above.

Nowadays we can only hope that a new revolutionary spirit may appear and will put an end to the dominance of cross-national global capitalism and the capitalism of oligarchs and bureaucracy in modern Russia.

A hundred years ago Russia accepted Marxism as an alternative to a "project Modern", the project of capitalist society. Russia will never be either an anti-western or a western country. Russia ought to pave her own way, her alternative way of historical development, complementary and at the same time standing in opposition to the West.

In a broader perspective the relevant task of philosophers (the way I see it) is to re-introduce the category of spirit into the terminology of contemporary Marxist philosophy of history as the central category. I emphasize it. The question remains open: outside modern Marxism what new meaning will the category of spirit acquire now and is there a necessity in this category in general? That's the most intriguing and provoking problem to solve in the philosophy of history today.



## **INTELLECTUAL WORK IN THE CONTEXT OF FREEDOM AND ALIENATION<sup>1</sup>**

Since ancient time thinkers have been attempting to understand essential meaning of work, its structure and main functions, and how is necessary and useful, as well as to compare with leisure and human life's dependency on it. It is known that intellectualization is becoming a prevailing trend in development of social work in our days, and is characterized through the increasing number of intellectual workers and the significance of their work for the society. The intellectual work is becoming crucial in all spheres of the contemporary production. The intellectual work requires from a worker the corresponding capacities, intelligence level, professional skills, education and knowledge. There are three capacities in the modern active, initiative life: work as biologically argued and hard, creation as a production of a new thing, action as self-sufficient act without any outcome thing. Among these three capacities the action is superior and truly free. The other two are necessary, but fraught with alienation and objectification. So, in ancient polis only the politics was an activity type that required an action, and thus, it was considered as a superior work (public life). In comparison to the political activity all other activities were "the work as needed" (or private life). Thus, activity without definite purpose, benefits and need was "an end in itself". The work for "benefits and need" and for provision of material wealth didn't have this philosophical meaning. The liberal citizen of polis, aristocrat "seems to possess beautiful and unvalued things/

---

<sup>1</sup> This paper has been done for the research project by the President of the Russian Federation for young scientists No. MK-4096.2013.6.

goods, but not valued and useful for something because the former is more characteristic to be self-sufficient” (Aristotle. Politics). So, the ancient thinkers evaluated “the work as needed” to be equivalent to slavery. And the higher degree of work usefulness was the more chance was that this type of work could be ranked as slavery. The absence in the work of such features as usefulness, benefits and need constituted the conditions for being a liberal individual. In the Age of Renaissance together with the increase of freedom in the human individual life, the action became superior as well, creative work itself.

The Reformation has brought the new attitude to work: the human salvation depends on the work intensity, patience, responsibility and ability to earn. This idea has been greatly developed in the Modern Age, and work stopped to be considered as “hard and slave” but as useful; the life became work, and the work was life, that was the own will of the person. The leisure got dependence on work, and albeit the antique tradition was no more associated with the life. According to the argument by H.Arendt, the Modern Age initiated the theoretical supreme of work in the 17<sup>th</sup> century, and it resulted in the beginning of the 20<sup>th</sup> century as a transformation of the society into the working society<sup>2</sup>.

It is known that the prevailing trend in development of social work today is its intellectualization that is characterized through the increasing number of intellectual workers and the significance of their work for the society. The intellectual work is becoming crucial in all spheres of the modern production. The intellectual work requires from a worker the corresponding capacities, intelligence level, professional skills, education and knowledge.

Nowadays, economists often claim that a person should devote more time to the education and honing the skills in order to be *more competitive* at the labor market as well as in life through accumulating own social capital and providing the better one for the society, of which she/he is a member [4, 5]. This necessity (*the needed*) of getting the new skills in the sphere of intellectual work leads to situations that a scholar should act as an entrepreneur, efficient manager and promoter of the research results. It is becoming quite common for developed countries

---

<sup>2</sup> Arendt, H. *Vita activa or about active life*. Sankt-Petersburg: Aleteya, 2000, p. 11 [in Russian].

that the professors at universities and heads of the laboratories create the start-ups and combine research work and practical application of their research outcomes<sup>3</sup>. Because of the higher competition during the last years the degree of “needed” and “fatal” is growing, and then it limits the freedom. This ideology is fueled by the colleagues, evaluation of “skills and competencies” by the recruiting educational and research bodies, need to advertise and promote the outcomes of own intellectual work (in case of a scholar, it includes the citation index, publications in the peer-reviewed journals, number of implemented projects and research, experience, etc.). All these circumstances make an intellectual worker to do the things, in which she/he is usually not into and to find a way guaranteeing the success – the *increasing demand* on her/his work. Therefore, *these attempts to measure* the intellectual work and its outcomes in fact destroy possibility to see it as an intelligent act and a way to human freedom.

At the same time another trend exists in the modern society, which is a spread idea about work as not only for living, but for leisure as well, that means the definite distinguishing of working life and leisure. The idea of ancient thinkers gets a new meaning here: activity as needed by material reasons only, is limited, and moreover, it causes the limits of human freedom and in substance provides her/his existence as a slave.

These trends witness the danger of objectification of intellectual activity that means opportunities for alienation of creative immaterial work. The methodology of Karl Marx helps us to identify these dangerous trends in the development of intellectual work in contemporary society, and find ways to avoid these problems.

Nowadays, the ideas of K. Marx are acute both in Russia and in the Western countries; many scholars (e.g., K. Cohen, A. Megille, T. Rockmore, J. Wolff, T. Dlugatch, V. Mezhuev, A. Buzgalin, A. Ballaev, B. Slavina and others) attempt to analyze them from the new perspective. We are keen to discuss the issue on that, how the contemporary forms of work which have got changed during intellectualization process, can be analyzed in terms of Marx, i.e. in alienation context and universality

---

<sup>3</sup> Becker, G. S. *Human Capital*. New York, Columbia University Press, 1964; Shultz, T. *Human Capital in the International Encyclopedia of the Social Sciences*. New York, 1968, vol. 6; Rifkin, J. *The End of Work: The Decline of the Global Labor Force and the Dawn of the Post-Market Era*. New York, Putnam, 1995.

of work. We are discussing such forms as intellectual (scientific) work, creative work, non-productive/immaterial work. The term “immaterial work” appears in dispute between Anri Storch and Adam Smith who considered such forms of work as non-productive. Then Marx understood a work in the framework of intellectual and creative activities as productive, i.e. which is associated with the production of common valued “immaterial” goods.

The division of work itself, according to Marx, appears in atomistic society, in which intellectual work is a privilege of the ruling class. The physical work is defined by Marx as immediate costs of labor force, and the creative work as “appropriation of own universal productive force”. Marx assumes impossibility to divide intellectual and physical works because both are connected to the thinking process. In the future classless society division of work on creative and physical criteria should have been overcome even at the individual level of a worker; therefore it will provide the new opportunity of freedom. Marx determines work as productive or non-productive not for internal characteristics (like prevail of intellectual or physical operations, absence or presence of the outcome product, materiality or immateriality), but through economic and social context. The outcome of immaterial work has “universal” specifics (ideas, images, etc.). Marx uses in “The economic manuscripts of 1857–1859” expression “general intellect” that means science, knowledge in general, including the practical knowledge which is more and more becoming the basis for the modern production. “Any scientific work, any discovery, any invention is universal” according to Marx, universal work has “scientific specifics and is a result of human activity not as behaved natural force, but as a subject performing during the production process as a ruler of natural forces”.

For example, truly free work like a composer is in reality very serious business, which implies according to Marx an extreme stress/pressure. Marx highlights in “The economic manuscripts of 1857–1859” that development of the ground capital is a criterion for universal social knowledge is reaching the level of transformation into *direct productive power*, and indicates to what degree the conditions of social life’s dependency on the control of general intellect and being changed under it, and to what degree social productive forces exist not only as a knowledge, but direct forces of social practice and real life process. Universal

work is the outcome not of direct physical (limited) forces of the individual, but the realization of deep, universal capacities, kin group and individual “essential forces”.

Marx develops work definition as “universal substance” and *universal possibility of wealth*, and then he says about destruction of work due to its alienation. According to Marx the working process as an attribute of human society is organic entity of activity and work instrument, and as a result the work outcome.

The alienation of work means transformation into activity that is opposite to itself and during doing which a person doesn't approve but denies one, “harasses physically and spiritually”, and the substance transforms into a “means of supporting the individual being” which is alien to the original substance. The source of alienation should be searched in the division of work leading to the contradiction between the interest of one individual and the common interest of all individuals; moreover, this common interest exists not only in the individual's conscious but in the reality as a form of interdependency among participants of the division of work. Vadim Mezhuev compares the works by Marx and by Arendt writes that “what for Arendt is an act of creation and action, for Marx it is universal work. He understood the freedom from work as a freedom not from any work, but only from the needed and abstract one. Agreeing the statement that work for own benefit is free from violence and coercion, he argued that such work might be coincided with the beneficial for others...The individual need for personal realization is expressed through universal work that results in the outcome of universal value...”<sup>4</sup>. Marx highlights importance “to minimize the needed work of the society instead of a shortage of necessary working time for surplus work; this corresponds to the individual development in art, science, etc. thanks to the available time and technologies”<sup>5</sup>. According to Arendt's idea, the work is not considered as a slave work if a person is independent and is able to provide it. The same activity might contain the slavery sign if it serves not for the personal independence, which is a supreme, but for the survival and if it doesn't demonstrate the personal sovereignty, but conformity to the necessity and need.

---

<sup>4</sup> Mezhuev, V. *Marx protiv marxizma. Stat'i na nepopulyarnuyu temu* [Marx against marxizm. The articles on unpopular topic]. Moscow, 2007, p. 134 [in Russian].

<sup>5</sup> Ibid.

Saying about alienation of work Marx means the physical kind of work, but nowadays, in the era of universal intellectualization, we can claim the danger of alienation concerning the creative intellectual work.

Concerning the idea to work not only for living, but for leisure as well, i.e. distinguishing the life “before” and “after” work, the issue on flexible working time, non-profit activity and the good of the intellectual work seems marginal and meaningless. This phenomenon indicates deep social and cultural crisis; people work mainly because it is impossible not to work, and their existence depends on their work. In this aspect, freedom is similar with the private life (leisure), not with the public one; and according to Marx the freedom starts when the person stops doing a work defined by need and external purposes. Thus, the work should be a part of spending free time (leisure). Probable solution might be *self-organization* of the intellectual work as the best common good results are achievable under the conditions when there is no coercion. Then, the profession will be associated with the mission, and the human capital will be considered not only as an instrument in the competition between workers and countries for innovative potential, and the lifelong learning will be a natural ambition instead of desire to increase a higher income and improve the status; and this will be the pure golden age for the intellectual work.

## VI. HISTORY OF PHILOSOPHY

*K. Dolgov*

### THE PHILOSOPHER AND PHILOSOPHY IN PLATO'S VIEW

From its very beginning ancient Greek philosophy was formed and developed as a very complicated phenomenon including a wide range of directions from naturalism to anthropomorphism, from the consideration of natural phenomena to the human being and his essence, from the phenomena of space scale – logos – to mythology and the analysis of the language. In this sense ancient Greek philosophy, covering a very long period in the history of Greece, showed the greatest conglomerate of philosophical schools, trends and directions that dealt with dialectics, logic, cognition, epistemology, ethics, aesthetics, etc. Therefore it is rather difficult to speak about ancient Greek philosophy as a single whole. Thus it is more often regarded as particular trends and directions of thought of a certain period: pre-Socratic philosophy, classical philosophy, Hellenistic philosophy, Neoplatonic philosophy.

We would like to focus on some aspects of classical philosophy, particularly, Plato's philosophy, since we consider it the most important component of the philosophy of the classical period.

Naturally, we are not able to analyze this philosophy in detail here, we shall only specify some of its distinctive features.

First of all we shall mention the fact that Plato treated philosophy in close connection with the philosopher and vice versa, as philosophy is the product of the creative philosophical mind, that is, the philosopher: what philosopher is like, so is philosophy, what philosophy is like, so is the philosopher.

But what is it to be a philosopher? Who is the philosopher? What is philosophizing and what is philosophy? Plato says the following: “philosophical minds always love knowledge of a sort which shows them the eternal nature not varying from generation and corruption”<sup>1</sup>, “his eye is ever directed towards things fixed and immutable, which he sees neither injuring nor injured by one another, but all in order moving according to reason;...these he imitates, and to these he will, as far as he can, conform himself”<sup>2</sup>; “he ...has magnificence of mind and is the spectator of all time and all existence”<sup>3</sup>; he is a man who “has the gift of a good memory, and is quick to learn,—noble, gracious, the friend of truth, justice, courage, temperance”<sup>4</sup>. According to Plato, “the disciples of philosophy are to be orderly and steadfast, not, as now, any chance aspirant or intruder”<sup>5</sup>. Plato believes that all the best and most valuable things in the society are done by a man who is “just, courageous, sensible, a philosopher”<sup>6</sup>. Besides Plato presents his own view on the philosopher’s life style: “his daily life makes him extremely susceptible, he has good memory and is able to reason: he is temperate and sober-minded and he never accepts the opposite life style”<sup>7</sup>.

Besides Plato believes it impossible to be a philosopher at a young age, one becomes the philosopher only when he has already acquired basic life experience and has become proficient in many sciences: “when they have reached fifty years of age, then let those who still survive and have distinguished themselves in every action of their lives and in every branch of knowledge come at last to their consummation; the time has now arrived at which they must raise the eye of the soul to the universal light which lightens all things, and behold the absolute good; for that is the pattern according to which they are to order the State and the lives of individuals, and the remainder of their own lives also; making philosophy their chief pursuit, but, when their turn comes, toiling also at politics and ruling for the public good, not as though they were per-

---

<sup>1</sup> Plato. *Complete collection of works in 4 vol*, Vol. 3, Moscow, 1994. Pp. 262–263 [in Russian].

<sup>2</sup> Ibid. Vol. 3, p. 281.

<sup>3</sup> Ibid. Vol. 3, p. 264.

<sup>4</sup> Ibid. Vol. 3, p. 266.

<sup>5</sup> Ibid. Vol. 3, p. 325.

<sup>6</sup> Ibid. Vol. 4, p. 487.

<sup>7</sup> Ibid. Vol. 4, p. 492.



forming some heroic action, but simply as a matter of duty; and when they have brought up in each generation others like themselves and left them in their place to be governors of the State, then they will depart to the Islands of the Blest and dwell there; and the city will give them public memorials and sacrifices and honor them, if the Pythian oracle consent, as demi-gods, but if not, as in any case blessed and divine”<sup>8</sup>.

Plato’s above statements from his “Republic”, “Laws” and “Letters” reveal the fact that he considered the image of a philosopher to be of great value since it is his qualities, talents and virtues that influence immensely not only on his philosophic views but also on the social system, family, society and the state itself.

Obviously, the philosopher is a person who must possess corresponding abilities, talents and virtues, first of all these are extraordinary mental abilities: sharp and deep mind, profound knowledge not only in the field of philosophy, but also in other disciplines, for the subject of his research, contemplation is life – something constant, eternal, identical to itself, the most lofty and perfect, which changes neither in time, nor in space. To consider the given subject, to understand it and to correspond to it, the philosopher himself must also be an extraordinary, universal and intellectually advanced person. Only then the corresponding relations between the object and the subject, contemplating and contemplated, cognizing and cognized can be established.

Therefore the philosopher must have an extraordinary constant thirst for continuous learning and perceiving the being. The philosopher differs in this sense from anyone else, including any scientist, any representative of the intellectual elite, as he constantly reflects on cognition itself from its origin to its modern state in order to move further, to develop the traditions of knowledge, learning truth and being. Here again can we see that the philosopher is a man who observes and perceives the divine structure of the world and space, the divine harmony of all the being. This constant reflection on the divine structure of all existing things makes him similar to a divinity, for cognizing divine entities inevitably leaves its imprint on the one who learns or cognizes. Thus, the philosopher is one of the highest creatures, this is not due to false pride, egoism or arrogance, but because he possesses extraordinary mind, mighty, advanced and perfect.

---

<sup>8</sup> Plato. *Complete collection of works in 4 vol*, Vol. 3, p. 325.

Evidently, this implies having extraordinary, advanced memory to keep all that was learnt, is being learnt and will be learnt. The main aim of the philosopher is learning the truth and following it, which, as a rule, is extremely difficult. Therefore the philosopher must possess such a virtue as courage: he must have enough courage to be constantly engaged in his search of truth, to be its herald, its bearer, its defender. Regardless of time periods, any situations, any forms and types of government the philosopher must search for truth and proclaim it, irrespective of dangers, prosecutions which can threaten him. He must fight for truth, have the courage to assert it and put its requirements into practice. This inevitably makes it necessary for the philosopher to possess such highest virtue as justice, for justice is the form of the existence of the true law, which, in turn, is based on truth. Hence, justice is the form of the existence of truth and if the philosopher serves the truth, he in the same way serves justice: he must fight for it always and everywhere, irrespective of any conditions in order to establish true justice in the society and the state.

As to such virtue as reasonableness, Plato considers it absolutely necessary for the philosopher not simply as a thinker, but also as a politician, as the ruler of the state for, according to Plato, philosophers must rule the state, and reasonableness is of vital importance, as the ruler is responsible for the destinies of uncountable number of people and before making any decisions on the social and the state system and pass corresponding laws, the ruler must carefully analyze these phenomena. Such virtues which, according to Plato, the philosopher must possess, not only distinguish him from all other people, but they are to a certain extent the result of reaching the balance between the internal spiritual nature of the philosopher and the objective laws of the existing world: the philosopher, possessing the given virtues, harmonizes himself, his essence with the world harmony and the world soul.

The purposes and the tasks addressed by the philosopher, determine his particular life style, quite different from the others, as he must constantly train his memory, the ability of logical reasoning. He is certainly supposed to live the moderate and sober life and by no means give it up in favour of any other.

All this determines not only the personality of the philosopher, according to Plato, but also his relationships with the world and thus his understanding of the structure of his research, conceiving and cognizing truth and the being. It is very well described by a famous philosopher Alkinoos:

«Firstly, the philosopher must possess a natural gift for sciences providing the knowledge of objects acquired through logical reasoning, rather than of those changeable and fluid; secondly, he must love truth and never accept lies; besides he must be modest and calm by nature, since the one who devotes himself to sciences, will never pursue pleasures. The future philosopher must also be independent in expressing his views: petty interests are the most hostile to the soul of the future explorer of the divinity and the man. And he must be fair by nature. Only when he loves truth, is independent and moderate, he will take the full advantage of his memory and his abilities, which also distinguish the philosopher ... According to Plato, the philosopher is actively engaged in three things: he observes and knows the existing things, does good and gives the theoretical analysis of the spoken words (λόγος). Knowing existing things is referred to as theory, knowing how to behave is practice, knowing the sense of the spoken words is dialectics»<sup>9</sup>.

Thus, Plato designed an extremely attractive image of the philosopher as a man possessing the highest properties and qualities of mind, soul and heart, as a man possessing encyclopaedic knowledge and virtues, as the devoted attendant of truth, good and justice, as a person having enough courage to fight for his ideas, ideals, the theories and his practical behavior.

According to this ideal image of the philosopher Plato builds his philosophy, lofty, universal and attractive.

Reading Plato's main dialogues, we can easily see that all his lofty and surprisingly wise philosophy is aimed at the construction of the best, ideal society and the state and, accordingly, the education of people, who are able to live in such a state and rule it. Plato thoroughly develops the principles of the legislation for the given state, following which, the people will contribute to building the most reasonable social and state system, beneficial not for some social strata, but for the whole society and every single person. Following the law is a sacred duty of every citizen, but to provide this everyone must be brought up in the spirit of absolute respect for the law. The aim of this state is the benefit of everyone, and moving towards this unites all citizens of the given state and makes them mutually helpful. Philosophers do not have to be en-

---

<sup>9</sup> Plato. *Complete collection of works in 4 vol*, Vol. 4, Pp. 625–626.

gaged in the state affairs in such a state, but they in any case must take care of all the citizens and do their best to make their life comfortable. Since they see, know and understand what is going on in the society and the state best of all, they are capable of getting rid of all shortcomings, flaws and evil, preventing the normal life.

“And thus our State which is also yours will be a reality, and not a dream only, and will be administered in a spirit unlike that of other States, in which men fight with one another about shadows only and are distracted in the struggle for power, which in their eyes is a great good. Whereas the truth is that the State in which the rulers are most reluctant to govern is always the best and most quietly governed, and the State in which they are most eager, the worst... for only in the State which offers this [proper order. – *K.D.*], will they rule who are truly rich, not in silver and gold, but in virtue and wisdom, which are the true blessings of life. Whereas if they go to the administration of public affairs, poor and hungering after their own private advantage, thinking that hence they are to snatch the chief good, order there can never be; for they will be fighting about office, and the civil and domestic broils which thus arise will be the ruin of the rulers themselves and of the whole State”<sup>10</sup>.

These Plato’s statements show that philosophers and philosophy give sound reasons for human freedom: freedom of thought, freedom of actions, freedom of speech. Only then the society and the state can develop properly, and here Plato appears to be the founder of the real philosophy in its true sense. Freedom, undoubtedly, generates responsibility, they are immanently connected: there can be no freedom without responsibility, nor responsibility without freedom. But what is responsibility in Plato’s view? It is the responsibility for everything that occurs in the family, in the society, in the state, and thus freedom and responsibility are the factors the human dignity is based on. Philosophy teaches freedom and responsibility, but what is more important, it teaches a man how to appreciate and preserve his dignity and how to appreciate other people’s dignity. Unfortunately, Plato did not see any reasonably formed states in his time: “I am upset as none of now existing state forms is worthy of the philosophic nature, and hence that

---

<sup>10</sup> Plato. *Complete collection of works in 4 vol*, Vol. 3, p. 302.

nature is warped and estranged”<sup>11</sup>. We only have to regret that after two and a half thousand years these Plato’s words can apply practically to all modern states and philosophers.

Why it so? It is because no modern state has ever made its aim the idea of universal good and, accordingly, justice, beauty, freedom, love and mercy, that is, the highest human values.

It is not by accident that Plato introduced his idea of the universal good as an ideal which the society, the state and all the people must try to attain: “the idea of good is the highest knowledge, and that all other things become useful and advantageous only by their use of this... every soul of man pursues good and makes the end of all his actions...”<sup>12</sup>. “the business of us who are the founders of the State will be to compel the best minds to attain that knowledge which we have already shown to be the greatest of all – they must continue to ascend until they arrive at the good...”<sup>13</sup>

The idea of the good put forward by Plato, left an indelible trace in the history of mankind. Each of us can at least recall the following words: thank, nobleness, good manners, blessing, piety, well-being, good conduct. All of them are based on the word “good” as the semantic core in the Russian language, and there are a lot of such words in Russian. But how important is the idea of good in the modern society, its culture and civilization nowadays? We have to ascertain its marginal position, though it must be the centre, the focal point for all kinds and forms of human life, particularly, concerning social and political aspects, the society and the state. And can the idea of good really occupy the central place in the life of the modern states representing, as a rule, such perverted forms as oligarchy, ochlocracy, democracy, tyranny?

Therefore Plato insisted that the state should be ruled by philosophers as the most educated, worthy, just representatives of the society and the state: “when the true philosopher kings are born in a State, one or more of them, despising the honours of this present world which they deem mean and worthless, esteeming above all things right and the honour

---

<sup>11</sup> Plato. *Complete collection of works in 4 vol*, Vol. 3, p. 277.

<sup>12</sup> Ibid. Vol. 3, Pp. 286–287

<sup>13</sup> Ibid. Vol. 3, p. 300.

that springs from right, and regarding justice as the greatest and most necessary of all things, whose ministers they are, and whose principles will be exalted by them when they set in order their own city”<sup>14</sup>.

Thus, Plato’s understanding of philosophy as constant striving for gaining knowledge of the being, the ability to contemplate the truth; the soul’s diligence and activity connected with the proper reasoning, remains the matter of topical interest. It is so since all – dialectics and logic, the profound knowledge of truth and being, that is, ontology and gnosiology, ethics and aesthetics, or axiological and aesthetic spheres – should aim at universal good as the ideal of the social, political and cultural life of the society and the state.

---

<sup>14</sup> Plato. *Complete collection of works in 4 vol*, Vol. 3, p. 326.

***KATHĒKON AND KATORTHŌMA***  
**IN THE EARLY STOIC ETHICS**

Stoicism is one of the first schools in the history of ethics that was characterized by stable interest in the issue of moral oughtness. Even predecessors of the Stoics, Democritus in particular, outlined that issue, but a consistent theory covering deontological issues (ideas of what is really “due” or “right” in human behavior) belongs to the Stoics as originators. Moreover, the solution to the issue of moral oughtness suggested by them produced a significant impact on further studies on that agenda.

In Stoic ethics, there exist two concepts that can purport to express oughtness of some kind, namely “appropriate” (*kathēkon*) and “right actions” (*katorthōma*). Those two concepts and the nature of their correlation bring into focus the specific character and uniqueness of the Early Stoa’s ethical doctrine, and at the same time, this is what its key issues and difficulties are directly connected with, when one tries to reconstruct and interpret Stoic ethics as a whole.

The researcher confronts the following challenge: both “appropriate” and “right actions” are defined by the Stoics as actions expressing dictates of nature and dictates of reason. It seems obvious that in this particular case we deal with two different conceptions of nature and reason, and, consequently, different conceptions of oughtness expressed by these two concepts.

The concept of *kathēkon* (“appropriate” or “proper”, in a wide sense) embraces actions of any natural being, namely fitting actions corresponding to its own nature, actions which arise from that

nature and obey the principle of harmonic unity, original accord of all living things. As applied to human being (here it is important to stress that a person other than the wise man is meant, i.e. a layman), appropriate actions for him are those that correspond to his nature as a biological and social being; they aim to achieve relative values, i.e. those that contribute to preservation and development of his nature. Rather than acting on impulse (as animals), human beings select their values through mediation of thinking and language; their choice must be justified in a dialog by appealing to universally recognized views on human nature and what befits it. Appropriate actions are deemed to be reasonable from the viewpoint of common sense, but not from the viewpoint of virtue; whether they agree with the purposes of universal nature is just a matter of probability. Taken separately, actions covered by the concept of “appropriate” are not included in the field of moral oughtness; they are included in external obligations imposed on a human being by his social and biological nature.

Moral oughtness in the true sense of the word is expressed by actions denoted by another term, *katorthōma*, which signifies “right” or “perfect actions” – actions according to virtue. They represent the *virtuous disposition of the soul* and possess all the principal features of virtue, namely, perfection, permanence, stability and coordination, order and legality. The very structure of the term illustrates the fact that it denotes actions carried out according to *true reason (kata ton orthon logon)*, which in the right and appropriate way expresses dictates of moral law. In Stoa’s ethical doctrine, actions of the wise man possess certain formal characteristics, such as following the *principle of constancy (self-consistency) and order*. Being in accord with the universal logos, all actions of the wise man are reasonable, have internal coherence, and obey one law, which lets the wise man always get what he proposes for himself.

Virtuous actions possess yet another feature, that of *opportuneness (eukairia)*. They are the most appropriate in a given moment and under given circumstances. To carry them out, not only moral disposition is required, but also capability of predicting further events; ability to assess circumstances; and the knowledge of *when* and *where* this or that action must be carried out or refrained from.



Taking the issue of the relationship between *kathēkon* and *katorthōma*, it must be noted that “appropriate” actions can be regarded as matter of virtuous actions. Taken in its pure sense, *katorthōma* expresses the principle of moral evaluation of various substantive actions. That principle is independent of the material to which it is applied, but cannot exist in complete isolation from that principle. In its turn, *kathēkon*, if taken separately, denotes only what it is carried out in an action or to what objects an action is directed. Therefore, “appropriate” has an abstract substance that can be matter both for virtuous or vicious actions, depending on how that substance is used. It is in that sense that it is called “medium appropriate” (*meson kathēkon*). In a certain respect, “medium appropriate”, just like “perfect appropriate” (*teleion kathēkon*), embraces a certain principle, but it is not a principle of *how* an action is carried out, but rather a principle of selecting material or objects. In other words, it is a principle of selecting *what* ought to be carried out by that action. Moral disposition of the soul, or correct attitude towards non-moral “goods” and recognition of virtue as the only purpose of aspirations, is the principal condition that makes an appropriate action morally right, or virtuous.

Any action that has been carried out in reality embodies both of these principles, and can be evaluated according to these two parameters. In the first case, the important thing is the principle of evaluating, firstly, the *substance* of a moral action, secondly, the local purpose achieved in that action, and, thirdly, the object of that action (whether it corresponds or not to human nature); and in the second case, another principle becomes important, that of evaluating the *intent* on the basis of which that action will be carried out (whether it corresponds or not to virtue). In an ideal case, the “right” substance corresponding to human nature is realized in accordance with the “right” intent, i.e. for the sake of virtue. Such actions are called *perfect appropriate actions* (*teleia kathēkonta = katortōmata*).

In some cases, however, not only “preferred” or “neutral” objects, from the viewpoint of natural aspirations of the human being, may become material for virtuous actions of the Stoic wise man, but also “non-preferred” or rejected objects, such as disease, death, murder of parents, etc. These actions are termed *kathēkonta peristatika* – appropriate due to circumstances. This concept means, that virtue of the wise man is

not only underlined by moral intent, but also by his ability to identify without error *where* and *when* this or that action must be carried out. Virtue of the Stoic wise man is not so much a “good intent,” but rather knowledge, and ability to anticipate events. In his *Paradoxa Stoicorum* Cicero speaks about admissibility of patricide, citing the example of people in the besieged city of Saguntum who “preferred to see their parents die free rather than live as slaves” (Cic. Parad. III. 2). That action in and of itself pursues the purpose which is contrary to human nature. But, in the opinion of the Stoics, that action is virtuous because it was carried out in extreme circumstances and at a moment when danger was imminent. That thesis of the Stoic doctrine reveals in a most eloquent way one of the above-mentioned features of morally right actions, i.e. their opportuneness.

Analyzing the relationship between *kathēkon* and *katorthōma*, we confront one specific peculiarity, which is an attribute of other ethics systems as well, besides Stoic ethics (for instance, Kant’s moral philosophy), in particular those ethics doctrines that judge of morality or immorality of actions mainly from the viewpoint of their motivation. Moral motivation (in case of the Stoics, virtuous disposition of the soul) cannot be witnessed from outside. An outside observer can evaluate only the factual substance of an action, its external correspondence to law or lack of that correspondence. Watching an action from outside, it is easy to evaluate it from the viewpoint of the principle of *what*, because that principle dictates what kind of objects ought to be chosen as purpose of human actions. At the same time, correspondence of that action to the principle of *how* is impossible to register and evaluate, because here the internal motivation of an action comes into play, or a certain way of treating the object at which that action is directed. Taking an action from its factual, or external, side, it is impossible to identify whether that action is virtuous or vicious, whether one deals with a wise man or a layman. Externally, their actions can be indistinguishable.

But at the same time, virtuous disposition of the soul is not just a motivation for an action but a stable condition, a system based on knowledge. Therefore, neither a layman can perform *katorthōma* by some kind of miracle (although he is capable of carrying out an action that has an outward appearance of *katorthōma*), nor a wise man can make a mistake. A wise man does *everything* the right way. It seems

that the correct mindset regarding “goods” and their correct treatment were, in the Stoics’ opinion, prerequisites for the wise man’s prosperity, as, so to speak, a “collateral effect” brought about by virtue. In some contexts we see that “external,” empirical, aspect of moral life to be regarded as visible and positive evidence of mental virtues of man. In writings of Cicero, Stobaeus, Clement of Alexandria and others, the Stoic wise man is represented as an embodiment of all possible perfections, from spiritual fortitude to pragmatism to religious piety. He combines qualities of an initiated priest privy to mysteries and of a magician capable of mantic predictions, of an experienced householder and of a just magistrate, of a ruler and of a law-abiding citizen; if he chooses so, he can lay his hands on abundant wealth.

Trying to overcome the duality of Plato and Aristotle’s systems, to a certain extent did the Stoics go back to the pre-Socrates idea of nature as a *single* generating source of growth and existence of the cosmos, which cannot be squeezed into the framework of the antithesis between ideal and material, between permanent and changing, between empirical and transcendent. That kind of retrospection, however, could not eliminate the original duality inherent in the very concept of *phusis*. When the Stoics elevated the principle of following nature (or correspondence to nature) to the rank of the universal yardstick for all human actions, unavoidably did they also transfer the duality of the concept of *phusis* into their own idea of appropriate life, and, at the same time, they emphasized the unity of the idea of nature.

The concepts of “appropriate” and “right actions” trace the oughtness expressed by them to their natural basis. But while in one case nature means biological nature that includes an urge to self-preservation, procreation, etc. (one might call it “natural” human nature represented in the doctrine of primary inclination), in the other, human nature is embodied in reason that coincides with the universal logos. In Stoa’s ethics, “appropriate” actions are oriented at empirical human nature, which exists in reality and reveals itself in human aspiration for useful and avoidance of harmful (level of *being*). On the other hand, virtuous actions follow that ideal image of nature that humans ought to achieve at some time (level of *oughtness*).

## IDEALISM IN EARLY GREEK PHILOSOPHY: THE CASE OF PYTHAGOREANS AND ELEATICS

There is a commonly held *endoxon* (or rather an established *dogma*) that idealism did not exist and could not exist before Plato since the “Presocratics” did not yet distinguish between the material and the ideal etc. This preconception is partly based on the misleading notion of “Presocratics” conceived as stubborn physicalists<sup>1</sup>. And this notion in turn derives from a simplistic evolutionist scheme of a “gradual development” from something “simple”, like material elements, to something “advanced” and “sophisticated”, like immaterial forms and intelligible world.

This evolutionist scheme is pseudo-historical<sup>2</sup>. It has ancient roots in Aristotle's *Alpha* of *Metaphysics* and it has become dominant in the 20-century mainstream positivist interpretation of the “Presocratics” influenced by John Burnet's “Early Greek philosophy». Aristotle conceived all history of Greek philosophy as a process of gradual discovery of his own four *arkhai*, the material cause was discovered first, because, in Platonist's view, matter is something primitive and simple. If we switch from the narrow-minded classist view of the Greek intellectual history to a broader comparativist view, we will find that “sophisticated” religious and idealist (or spiritualist) metaphysics and cosmogonies

---

<sup>1</sup> Lebedev (2009) “Getting rid of the “Presocratics”.

<sup>2</sup> Hugh Lloyd-Jones in his “Justice of Zeus” (1983 : 10) rightly calls for resistance to the evolutionist approach in the history of Greek moral thought (the alleged “primitivism” and absence of will in Homeric moral psychology). On similar lines Bernard Williams in “Shame and Necessity” rightly criticizes evolutionist histories of Greek ethics.

were known long before Plato in different archaic traditions<sup>3</sup>, whereas “simple” physical theories of elements, like those of the Ionians, and naturalistic cosmogonies of the vortex-type, had been unknown to humanity until the Scientific revolution in the 6<sup>th</sup> century Miletus.

The “standard” evolutionist scheme does not square well with what evolutionist psychology and anthropology tells us about primitive mind and history of consciousness, either. Metaphysical objective idealism is akin to panpsychism which in turn, cannot be separated from animism. Plato’s metaphysics of two worlds appears in the dialogues of the middle period not alone, but as part of complex that comprises the archaic doctrine of transmigration held by many “primitive” tribes.

Plato was an artistic (and dialectical) genius who only gave new form to ancient metaphysical doctrines. His metaphysics of two worlds derives from the Eleatic dichotomy of the intelligible and the sensible, his notion of the immaterial form from the Pythagoreans: we agree with Jonathan Barnes that the Pythagorean principles *peras* and *apeiron* prefigure later distinction between form and matter<sup>4</sup>.

Historians of Greek Philosophy have often been prone to seriously exaggerate the originality of Plato's doctrines. It has been thought, e.g. that the notion of *demiourgos* has been invented by Plato and is typically Platonic<sup>5</sup>. In fact it is an extremely archaic notion that has been revived, not invented by Plato. It was known to ancient Egyptians thousands years before Plato (see note 3), it is attested in Pherecydes of Syros who turns Zeus into craftsman (B 1. 2–3 DK). The divine cosmic mind in Heraclitus<sup>6</sup> and Anaxagoras, the *Philotes* (*Aphrodite-Harmonia*)

---

<sup>3</sup> On “subjective”, spiritualist and “magical” dimension of Ancient Egyptian creation stories see Allen 1988, p. IX et passim. The ancient wisdom of Upanishads with its principle “Tat Tvam Asi” (Chandogya Upanishad 6.8.7), identifying the subjective Self (Atman) with the Cosmic Absolute (Brahman) is as idealistic as any idealist metaphysics can be.

<sup>4</sup> Barnes (1979) vol. 2, p. 76.

<sup>5</sup> David Sedley (2007) now correctly recognizes the Pre-Platonic origin of creationism in Greek philosophy, but Anaxagoras, in our view was preceded by the Pythagoreans and Heraclitus.

<sup>6</sup> B 41 DK with Γνώμη meaning “Intelligence, Mind”, not “thought”. I emend the text as follows: ἐν τῷ Σοφῶν ἐπίστασθαι· Γνώμην ἦτε οἷα ἐκυβέρνησε πάντα διὰ πάντων – “One should recognize only one Wise Being (i.e. God): the Mind which alone steers the whole Universe”. Ἐπίστασθαι is *infinitivus quasi imperativus* (as

of Empedocles function as a kind of *demiourgos* as well. The Stoic *pyr tekhnikon*, on our view, derives from Heraclitus, not from Plato's "Timaeus"<sup>7</sup>. We have tried to demonstrate elsewhere that the notion of the cosmic demiourgos may have been not unknown to Thales of Miletus<sup>8</sup> and there are good reasons to believe that the doxographical evidence on *demiourgos theos* in Philolaus' cosmogony is not a Platonizing interpretation, since it is based on the authentic analogy with ship-building in Philolaus' text<sup>9</sup>. The cosmic Ship-Builder in Philolaus may well have been identified with *Nous*; it corresponds to the "third principle", a kind of *causa efficiens*, introduced by Philolaus in B 6 DK under the name of Harmonia<sup>10</sup>.

Those who deny the existence of idealism in Greek philosophy commonly refer to the well known article by Myles Burnyeat<sup>11</sup> who follows Bernard Williams<sup>12</sup>. The opinion of Burnyeat has been for some time re-

---

in laws) and has the same meaning "to hold, to recognize" as in B 57. Πάντα διὰ πάντων (literally "all thing throughout", "all things to the last one") is an archaic idiom for the Universe, as in Parmenides B 1.32.

<sup>7</sup> A neglected fragment of Heraclitus cited by Aristotle in De Caelo 304 a 21 (all things are generated from the original fire "as if from gold sand that is being melted», καθάπερ ἂν εἰ συμφοσσωμένου ψήγματος) shows that already in Heraclitus Fire was conceived as Craftsman: the cosmogonical process is analogous to χρυσσοχοϊκὴ τέχνη. The alternative interpretation (smelting of ore with separation of gold from base) that tries to connect this simile with B 31 (separation of the sea into two halves) is less likely. See Lebedev (1979–1980). In favour of the Heraclitean source of the Stoic notion of Nature as craftsman also speaks the fact that in Plato the demiourgos is an immaterial entity (Nous), opposed to matter, whereas both Stoics and Heraclitus identify the creative principle with a physical essence, fire. Plato follows Pythagorean dualism, the Stoic and Heraclitus follow the tradition of the Ionian naturalistic monism, though they also reinterpret the *physis* of the Milesians teleologically.

<sup>8</sup> Lebedev (1983).

<sup>9</sup> Philolaus A 17 DK = Stob. 1.21.6d. No doxographer could ever invent *ad hoc* the image of keel (τόπος) as a basis of the whole construction.

<sup>10</sup> Note that in Empedocles too, Harmonia is an alternative name for the creative force of Love. Empedocles and Philolaus seem to depend on the same common source, i.e. on ancient Pythagorean tradition that may go back to Pythagoras. *Tetraktys*, which is recalled in the ancient Pythagorean oath (58 B 15 DK), almost certainly goes back to Pythagoras, and it is a symbol of divine Harmony on which "the whole kosmos" is built according to Aristotle's reliable evidence.

<sup>11</sup> Idealism and Greek Philosophy: What Descartes saw and Berkeley Missed, in: *The Philosophical Review*, vol. 91, No. 1 (1982), Pp. 3–40.

<sup>12</sup> Williams (1981).

garded as established truth. But this is no longer the case. The bold thesis of Burnyeat (who claimed that idealism was unknown not only to the Pre-Platonic philosophers, but also to Plato and the whole of Greek philosophy) has been justly criticized first by distinguished Neoplatonic scholars<sup>13</sup>, and then also by some serious students of Hellenistic philosophy, especially of the ancient scepticism<sup>14</sup>. We believe that Burnyeat's thesis can be refuted in the case of the early Greek philosophers as well on the following grounds: 1) It is based on a selective and incomplete data from early Greek philosophy. 2) For some reason Burnyeat understands by "idealism" only one and rather special form of idealism, the so called subjective idealism (though he does not use this term). Our impression is that by "idealism" Burnyeat means "anti-realism". This is indeed a very rare and hard to find in Greek philosophy doctrine (though not unknown, cf. below). Ancient Greek rationalistic idealism as a rule is a form of objective idealism, it supports realism and defends it from the alleged "subjectivism" and relativism of the sensationism. In this study we understand by "idealism" a metaphysical doctrine that the nature of reality is either mental (wholly or partially) or is otherwise determined by mind or knowledge, or that the world is structured or created by an objective and divine cosmic mind. Accepting this broad meaning of the term, we can distinguish several forms of idealism in Greek thought: 1) dualistic idealism (Pythagoreans, Plato); 2) monistic idealism (Eleatics, some Platonists and all Neoplatonists); 3) Subjective idealism; 4) Linguistic idealism. Of these four forms of idealism the first two are strictly realist, only the third and the fourth are anti-realist. Few, if any, Greek philosophers claimed to be subjective idealists themselves. Something like this appears in Gorgias' script *περὶ τοῦ μὴ ὄντος* and in Xenias of Corinth (81 DK). Subjective idealism was commonly polemically *ascribed to others*. Thus Heraclitus states that most humans live in dream-like private worlds of doxastic imagination (B 1 DK and context). But in order to ascribe subjective idealism to others one had to know what it was. A special form of subjective idealism was linguistic idealism. In Parmenides B 8.54 the revealing goddess explains to Kouros that the illusionary world of doxa is the result of a linguistic mistake committed by mortals when they wrongly assigned a name to a non-entity. Night is the absence of Light, not a separate substance. Heraclitus in his theory of ordinary names (which

<sup>13</sup> Sorabji (1983), Beierwaltes (1985), Emilsson (1996 : 245 ff.), Moran (2000).

<sup>14</sup> Groarke (1990), Fine (2001 : 137 ff.; 2003 : 192 ff.).

correspond to subjective “smells” in B 67 DK) also regarded the poets and the un-philosophical mob as subjective idealists (using our modern terminology). In a sense, Heraclitus is linguistic idealist himself with regard of the phenomenal world. For Heraclitus real is only the Universe as a whole conceived as Logos<sup>15</sup>. The phenomenal opposites, taken separately, are like letters, the pairs of opposites – like syllables (συλλάβηαις). Syllables have no meaning of their own and therefore denote nothing. Only the Universal Logos in which all phenomenal syllables are integrated, has meaning and is real. The mysterious “dream theory” in Plato’s *Theaetetus* 201d is an anonymous quotation from Heraclitus<sup>16</sup>. Socrates’ remark that he “heard” this theory in a dream is a humorous and ironical allusion to the Heraclitean image of “dreamers” in B1. According to Heraclitus, all humans fail to understand the Universal Logos because they are dreaming. Socrates’ remark means “since I am mortal, I am dreaming too, and cannot understand precisely the wisdom of Heraclitus’ theory of logos” (in fact he refutes him). Incidentally, if our reconstruction of the grammatical analogy in Heraclitus’ metaphysics is correct (as we believe it is, because it is confirmed by a remarkable consensus of independent ancient readers of Heraclitus), the claims of ancient sceptics (Aenesidemus) that Heraclitus’ philosophy constitutes a “path” towards scepticism, are not totally unfounded<sup>17</sup>. Heraclitus denied the objective existence (κατὰ φύσιν) of the of phenomenal plurality of things. He believed that “letters” and “syllables” of the cosmic Logos (which stand for separate phenomena) cannot be known, only perceived by the senses. But in his henology Heraclitus was not sceptic at all, he was utterly dogmatic. The essence of wisdom, he states in B 50, is “to know all things as one”, ἐν πάντα εἰδέναι.

New light on the Pythagorean roots of Plato's doctrine of the soul is shed by the so called “Orphic” graffiti on bone plates from Olbia (5<sup>th</sup> century B.C) which in fact are not “Orphic”, but kleromantic devices, distant ancestors of the Tarot cards<sup>18</sup>. One of these contains the Pythagorean

<sup>15</sup> See Lebedev (2013) for details.

<sup>16</sup> See Lebedev, “Four anonymous quotations from Heraclitus in Plato’s dialogues” (forthcoming).

<sup>17</sup> On this much debated topic see Polito (2004).

<sup>18</sup> An important addition to the editio princeps in VDI was made by J. Vinogradov, the word σῶμα that is paired with ψυχή. We analyze these graffiti in detail in a forthcoming paper “Orphica and Pythagorica in the kleromantic bone plates from Olbia”.



symbol of *psyche* (*tetragonon*) on the one side, and the words ψυχή – σῶμα on the other. We reconstruct from them a four-pair table of opposites similar the συστοιχίαι adduced by Aristotle in *Metaph. Alpha*.

Ψυχή Σῶμα  
Βίος Θάνατος  
Εἰρήνη Πόλεμος  
Ἀλήθεια Ψεῦδος

This means that the soul is immortal, the body is liable to death. The soul belongs to the transcendental world of eternal piece (bliss), the body, composed of fighting opposites, belongs to the world of Strife and decay. And, last but not least, the soul knows the truth (intelligible world), the body through the senses perceives only *pseudos*. Here we have a brief summary of Platonism known to a street diviner in Olbia in the last quarter of the 5<sup>th</sup> century B.C. We identify this “Olbian chresmologue” with “Pharnabazos, the diviner if Hermes” known from another graffito<sup>19</sup>.

We argue against modern naturalist interpretations of Pythagorean first principles by Huffman and others<sup>20</sup>. Both in the Table of opposites (58 A 5 DK) and in Philolaus (44 B 1) πέρας καὶ ἄπειρον (or ἄπειρα καὶ περαίνοντα) denote self-subsistent mathematical essences, “out of which” (cf. ἐξ ἀπείρων κτλ.) physical bodies (cf. φύσις *ibidem*) are composed. It is impossible to interpret “the limit and the unlimited” (or “limiters and unlimiteds”) as physical bodies themselves or properties of physical bodies. This is confirmed by the clear evidence of Aristotle (*Metaph.* 987 a 15–19, cf. *Phys.* 203a 4–6; a16 ff.) who says that in Plato and Pythagoreans *hen*, *peras* and *apeiron* are self-predicative substances (οὐσίαι), whereas the naturalists regard *apeiron* as an attribute of “another” *physis* (like ἄπειρος ἄηρ of Anaximenes).

We believe that the «materialist” interpretation of Parmenides’ Being is not “one of”, but “the” most serious mistake ever committed in the study of Greek thought<sup>21</sup> It has had catastrophic consequences and resulted in the serious distortion of the development of Early Greek philosophy.

<sup>19</sup> Lebedev (1996) “Pharnabazos, the diviner of Hermes”.

<sup>20</sup> Huffman (1993) 37 ff.

<sup>21</sup> It was John Burnet in his “Early Greek Philosophy” who for the first time declared Parmenides “the father of materialism”: “Parmenides is not, as some have said, the “father of idealism”; on the contrary, all materialism depends on his view of reality” (Burnet 1920 : No. 89).

The root of this mistake is the misinterpretation of the non-being (or *kenon*) as *absence of body*, and the consequent identification of ἐόν with body or material substance. But Parmenides never and nowhere states that τὸ ἐόν is corporeal. The basic opposition of the *Aletheia* (being vs. non-being) exactly corresponds to the basic opposition of *Doxa* (Light vs. Night). Light (or celestial fire) is the spiritual and thinking element, Night is the “heavy”, dense, corporeal substance. Light and Darkness are roughly the soul and the flesh of the sensible cosmos. There can be little doubt that Being of the *Aletheia* corresponds to the Light in *Doxa*, and Non-Being of *Aletheia* corresponds to the Night in *Doxa*. This means that – exactly as in the Olbian graffiti – body is ψεῦδος, an illusion and a non-entity. By “empty” Parmenides means not the empty space of Democritus, but the “absence of mind”, i.e. body. Thus the philosophy of Parmenides is a radical form of immaterialism and idealistic monism. The fragment B 3 means what it clearly says in plain Greek “to be and to think is one and the same”, i.e. all being has mental nature.

It becomes clear that Parmenides’ τὸ ἐόν is a cryptic name for divine Absolute. Greek philosophers for some reasons (fear of γραφή ἀσεβείας or just mystical language for “initiates” into philosophical mysteries, εἰδότες φῶτες) sometimes preferred to avoid in their philosophical theology the word θεός. Heraclitus speaks of τὸ Σοφόν, Plato of τὸ Ἄγαθόν. In Parmenides τὸ Ἐόν means the real god of the philosophers as opposed to the imaginary gods of the poets: let us not forget that the second part of the poem, the way of *Doxa*, contained a complete polytheistic theogony (28 B 13 DK) thus exposing the traditional mythopoetic gods as an illusion and poetic fiction. Both in Parmenides and Xenophanes god is conceived as a mental sphere<sup>22</sup>. Xenophanes’ god

---

From his critical remarks about Hegel (No. 68 with note 57 against Lassale and Hegel’s claims of appropriating Heraclitus’ logic) it becomes clear that by his “materialist” interpretation of Parmenides Burnet intended to refute German «idealist” interpretations of Greek philosophy and so to undercut German claims about special connection between Greek philosophy and German idealism. But Burnet’s interpretation is based on the grammatically impossible reading of 28 B 3 DK. For a history of modern approaches to Parmenides see the important work of Palmer (2009), chapter 1.

<sup>22</sup> The sphericity of Xenophanes’ god is attested by the consensus of doxography MXG 971 b21, 978a20; Hippolytus (21 A 33 DK), Alex. Aphrod. ap. Simplic (A 31 DK), Sextus (A 35 DK). Timon’s ἴσον ἀπάντη also may allude to the spherical shape. For additional theological fragments of Xenophanes see Lebedev (1985) and (2000). Cf. Cerri (2001).

οὔλος νοεῖ (21 B 24) because he is 100% νοῦς, and Timon describes Xenophanean god as “more intelligent (or spiritual) than mind”, νοερώτερον ἢ ἐ νόημα (21 A 35 DK). Although Parmenides may have been partly influenced by Xenophanes, it seems more likely that both depend on the common ancient Pythagorean tradition. And another «Italiote» philosopher with Pythagorean background, Empedocles, also speaks of divine Σφαῖρος<sup>23</sup>. From this it follows that the ancient tradition about Parmenides’ Pythagoreanism is to be taken seriously<sup>24</sup>. And so a conjecture lies at hand that the father of the Greek philosophical idealism was Pythagoras of Samos. In our view the so-called “Eleatic school”, τὸ Ἐλεατικὸν ἔθνος in Plato’s words, was a branch of the Pythagorean school. The Eleatic philosophers accepted the basic doctrine of Pythagoras (immortality and divinity of the soul, the “shadowy” nature of body)<sup>25</sup>, but introduced two innovations: 1) they replaced the orthodox dualistic metaphysics by a strict idealistic monism, 2) in philosophical theology they replaced mathematical models and numerological symbolism by pure logic and deductive method. The subsequent history of the Eleatic school confirms this and demonstrates the adherence of its members to the Pythagorean idealistic paradigm. Melissus by no means was an original thinker, he just compiled a summary exposition of the Eleatic doctrine in prose. In fr. B 9 he states explicitly that τὸ ἓν is incorporeal (σῶμα μὴ ἔχειν). Zeno’s paradoxes in all likelihood were not a “disinterested” intellectual enterprise or a scientific investigation of the problems of motion and plurality. They served dogmatic purposes of the Pythagorean creed and defended Parmenides’ philosophical theology from the mockery of the profane. Zeno’s intention was to demonstrate that the material world is an illusion and the body is ψευδός.

Unlike classical German idealism the Ancient Greek idealism of the archaic and early classical period (Pythagorean and Eleatic) was not just an intellectual movement and had no romantic stamp. It served

<sup>23</sup> Empedocles, however, breaks from the Eleatic idealistic monism. His philosophy of nature is an attempt to reconcile Ionian naturalism with Pythagorean dualism.

<sup>24</sup> Parmenides had a Pythagorean teacher Ameinias, Sotion ap. D.L. 9.21; not only Neoplatonists (28 A 4 DK), but also Strabo regards Parmenides and Zeno as members of the Pythagorean brotherhood, ἄνδρες Πυθαγόρειοι (28 A 12 DK).

<sup>25</sup> A kind of reincarnation in Parmenides is attested by Simplicius in the context of B 13: καὶ τὰς ψυχὰς πέμπειν (scil. τὴν Δαίμονα) ποτὲ μὲν ἐκ τοῦ ἐμφανοῦς εἰς τὸ ἀειδέξ, ποτὲ δὲ ἀνάπαλιν φησιν.

practical – both ethical and political – purposes, its aim was education of ideal citizens and ideal warriors. Life in the new Greek colonies of the West was full of dangers and the polis required heroic and ascetic ethics from its citizens in order to survive. Eleatic doctrine provided necessary spiritual discipline for this both by placing the One above the many (and so submitting individual to the common) and by teaching that pain, suffering and death are not to be feared because our bodies are non-entities, σκιὰ καπνοῦ. A Pythagorean or Eleatic warrior would face death without fear because he knew that if he is killed, his immortal soul would suffer no harm, on the contrary it would be embraced by the sphere of divine Light and he would enjoy eternal bliss (τερπνὸν ἔχει βίον 36 B 4 DK). Now we can better understand the connection between Parmenides’ philosophy and his role of *nomothetes*. We can better understand why a professional military man, admiral Melissus, was an ardent adherent of the Eleatic doctrine. And again we can better understand why the biographical tradition depicts Zeno as a legendary hero who is indifferent to pain and overcomes the fear of death. Typologically Pythagorean and Eleatic ethics prefigures the Stoic spiritual discipline of endurance and ἀπάθεια<sup>26</sup>.

## Bibliography

Allen G.P. (1988): *Genesis in Egypt: The Philosophy of Ancient Egyptian Creation Accounts*, Yale University (New Haven, Connecticut), 1988.

Barnes, Jonathan (1979): *The Presocratic Philosophers*, vol. 1–2, Routledge & Kegan Paul, 1979.

Beierwaltes, Werner (1985): *Denken des Einen. Studien zur neuplatonischen Philosophie und ihrer Wirkungsgeschichte*, Frankfurt, 1985.

Burnet, John (1892): *Early Greek philosophy*, London, 1920 (3<sup>rd</sup> ed.; 1892, 1<sup>st</sup> ed.).

Burnyeat, Myles (1982): Idealism and Greek Philosophy: What Descartes saw and Berkeley Missed, in: *The Philosophical Review*, vol. 91, No. 1 (1982), Pp. 3–40. Reprinted in Vesey (1982) 19–50 and Burnyeat (2012) vol. 1, 245–275.

Burnyeat, Myles (2012), *Explorations in Ancient and Modern Philosophy*, vol. 1, Cambridge UP, 2012.

---

<sup>26</sup> On the connection between Stoic philosophy and military mind see Sherman (2005).

Denyer, Nicholas (1991): *Language, Thought and Falsehood in Ancient Greek Philosophy*, Routledge, 1991, p. 214, note 2.

Cerri, Giovanni (2001): Il frammento Lebedev di Senofane, in: *QUCC* 2001, N. S. No. 69, Pp. 25–34.

Emilsson, E.K. (1996): Cognition and its Object, in: L.P.Gerson (ed.), *The Cambridge Companion to Plotinus*, Cambridge UP, 1996, Pp. 217–249.

Fine, Gail (2003): Subjectivity, Ancient and Modern: The Cyrenaics, Sextus and Descartes, in: *Miller & Inwood* (Edd.), (2003), 192 ff.

Fine, Gail (2001): Relativism and Self-Refutation: Plato, Protagoras and Burnyeat, in: *J. Gentzler, ed.* (2001), Pp. 137–164.

Gentzler, Gyl (2001): *Method in Ancient Philosophy*, Oxford UP, 2001.

Groarke, Leo (1990): *Greek Scepticism. Anti-Realist Trends in Ancient Thought*, Montreal & Kingston, 1990.

Huffman, Carl (1993): *Philolaus of Croton*, Cambridge UP, 1993.

Hylton, Peter (1990): *Russell, Idealism and the Emergence of Analytic Philosophy*, Oxford, 1990.

Lebedev, Andrei (2009): «Избавляясь от “Досократиков”»: “Getting rid of the ‘Presocratics’”, paper delivered at the Round Table “Getting rid of Stereotypes” at the International UNESCO Day of Philosophy Annual Conference held in the Institute of Philosophy, Moscow, 14–15 November, 2009; published in: *Filosofia v dialoge kul'tur (Philosophy in the dialogue of cultures)*, Moscow, “Tradition”, 2010, Pp. 177–183.

Lebedev, Andrei (1979–1980): “ΨΗΓΜΑ ΣΥΜΦΥΣΩΜΕΝΟΝ” A new fragment of Heraclitus, in: *Vestnik Drevnei Istorii*, 1979, No. 2, Pp. 3–23; 1980, No. 1, Pp. 29–48. [in Russian with English summary].

Lebedev, Andrei (1983): “Demiurg u Falesa?” (“Demiourgos in Thales?”), Text: *Semantica i Structura*, ed. T. V. Tsivyan. Moscow, 1983, Pp. 51–66. [in Russian].

Lebedev, Andrei (1985): A new fragment of Xenophanes, in: *Studi di Filosofia Preplatonica*, Napoli, 1985, p. 13 sq.

Lebedev, Andrei (1996): Pharnabazos, the Diviner of Hermes: Two Curse Letters from Olbia, in: *Zeitschrift für Papyrologie und Epigraphik*, Bd. 112 (1996) 268 sq.

Lebedev, Andrei (2000): Xenophanes on the Immutability of God. A Neglected Fragment in Philo Alexandrinus, in: *Hermes*. Bd. 128 (Wiesbaden 2000), S. 385–391.

Lebedev, Andrei (2013): “This logos” as *Liber Naturae* in Heraclitus B 1 and B 50 DK”, paper at the International conference “Heraklit von Ephesos und seine Zeit” 7–12 Oktober 2013, Selcuk Municipality, Turkey.

Lloyd-Jones, Hugh (1983): *The Justice of Zeus (Sather Classical Lectures vol. 41)*, Berkeley and Los Angeles, 1983.

Miller, Jon and Inwood, Brad (Edd.) (2003), *Hellenistic and Early Modern Philosophy*, Cambridge UP, 2003.

Moran, Dermot (2000): Idealism in Medieval Philosophy: The Case of Iohannes Scottus Eriugena, in: *Medieval Philosophy and Theology*, 8 (1999), 53–82, Cambridge University Press 2000.

Palmer, John (2009): *Parmenides and Presocratic Philosophy*, Oxford UP, 2009.

Polito, Roberto (2004): *The Sceptical Road: Aenesidemus' Appropriation of Heraclitus'*, Leiden: Brill, 2004.

Sedley, David (2007): *Creationism and its Critics in Antiquity*, Berkeley & Los Angeles, 2007.

Sherman, Nancy (2005): *Stoic warriors. The Ancient Philosophy behind the Military Mind*, Oxford UP, 2005.

Sorabji, Richard (1983): Gregory of Nyssa: The Origins of Idealism, in: *Time, Creation and Continuum. Theories in Antiquity and the Early Middle Ages*, London, 1983, Pp. 287–296.

Vesey, Godfrey (ed.) (1982): *Idealism – Past and Present*, Cambridge UP, 1982.

Williams, Bernard (1981): Philosophy, in: M.I.Finley (ed.), *The Legacy of Greece. A New Appraisal*, Oxford UP, 1981, p. 4 ff.

Williams, Bernard (2008): *Shame and Necessity*, Berkeley & Los Angeles, 2008.

*M. Stepanyants*

## REFLECTIONS ON METAPHYSICS OF RUSSIAN CULTURE

Who would grasp Russia with the mind?  
For her no yardstick was created:  
Her soul is of a special kind,  
By faith alone appreciated.  
(trans. by John Dewey)

This quatrain, written November 28, 1866 by Russian poet Fyodor Tyutchev, has become widely popular opinion about Russia and its culture. So much that even former French President Jacques Chirac, while receiving the State Prize of the Russian Federation, recited this verse from Tyutchev, and Vladimir Putin at the meeting in the Kremlin with President Nicolas Sarkozy read the same quatrain.

Fyodor Tyutchev looks at the culture as the manifestation of the soul of the people. Hence he defines Russian culture in tune with his philosophic views. In **Silentium** – an archetypal poem by Tyutchev written in 1830 it is said:

How can a heart expression find?  
How should another know your mind?  
Will he discern what quickens you?  
A thought, once uttered, is untrue.

.....

Live in your inner self alone  
within your soul a world has grown,  
the magic of veiled thoughts that might  
be blinded by the outer light,  
drowned in the noise of day, unheard...  
take in their song and speak no word.  
(trans. by Vladimir Nabokov)

What is that which is not comprehensible rationally and requires only faith? The first that comes to the mind in response are the Sacraments like those of Christianity (Baptism, Christmation, The Eucharist, Confession, and Priesthood). Should then Tyutchev's poetic image of Russia mean that its culture contains the Sacraments or using everyday language, its own Mystery inconceivable by reason? Many are inclined to respond positively. I would dear to disagree, and rather say that Russia, its culture, holds its own metaphysics that is a temporary substitute of unknown or unknowable.

There is no better way to comprehend so called metaphysics of Russian culture than hermeneutic reading of literature which is the mirror reflecting the Russian identity. National identity is like a human character: it is not given once and for all from God, but it is rather made up of layers of unique biographical coincidences of every person, every nation. One can say it is not monolithic, and multilayered, shaped by history. Moreover, these layers are not just different they might be in antinomy towards each other.

Those antinomies have got their reflection in what Nikolay Berdyaev called "the mystery of the Russian soul". In his words, "To get at the riddle of the mystery hidden within the soul of Russia is possibly at the same time to admit the antinomic aspect of Russia, its keen contradictions. The enigma is why a most unstate like people has created such an immense and mighty state; why so anarchistic people is so submissive to bureaucracy; why a people free in spirit as it were does not desire a free life?"<sup>1</sup>

Antinomy in any culture manifests itself in different forms: of elite and popular culture, of 'heritage' and the 'avant-garde', etc. But for Russia there are overly specific antinomies.

Russian history clearly demonstrates that in the long course of its existence Russia failed in discovering its place in the world: Russia cannot define itself neither as the East nor as the West, nor as an East-West, a 'unifier of the two worlds'.

---

<sup>1</sup> Berdyaev, N. Russian Soul. Moscow: I. D. Sytin, 1915. There after incorporated into Berdyaev. "The Fate of Russia". Moscow: G. A. Leman and C. I. Sakharov, 1918 as the sequentially lead article. English translation by Fr. S. Janos. 2008.



At the certain stages of its history Russia made choices expressing the wish to belong entirely to the West. One should remember that it made a choice in favor of westernization a number of times. But each time Russia failed to bring the process to the end. Two examples are particularly relevant. In the 10<sup>th</sup> century under the rule of Prince Vladimir (980–1015) the adoption of Christianity as the state religion allowed Kiev Rus to join the Western community. However, this opportunity was not fully utilized for a variety of reasons both of external and internal order. In the end, chance was lost: Mongol invasion and Mongol Golden Horde rule for nearly three centuries virtually isolated Russia from the West.

The second example is “the opening of a window to Europe” by Peter the Great (1689–1725). Despite significant achievements of Peter the Great, Catherine the Great (1726–1796), and Alexander II (1855–1881) in the reforming social, economic and political systems, Russia did not become completely westernized. The further process was blocked by the October revolution. A preference was given to Soviet Socialist model of development. As a result, for almost seven decades Russia was virtually isolated from the West by the iron curtain.

Thus for centuries Russia remained a perpetual oscillation between two poles expressed in the Russian culture as *zapadnichestvo* and *aziatchina*, that is between West and East.

What were the basic causes of that uncertainty?

Geographical position: the immense territory, the borders stretch, openness for the invasions, etc.

The choices were made by the authority that is from the above, while the people stayed passive, unable to express its aspirations and preferences due a crucial impact of three centuries of Mongol yoke and of three centuries of serfdom.

The uncertainty with the choice, permanent fluctuation affected the culture of the nation: it stayed in constant search of the truth and recourse to a higher power (God or the Ruler); in steady possession of guilt feeling and self-criticism; in glorification of patriarchal way of life, community (*obshchinnost*, *sobornost*) or, on the contrary, in idealization of the Western institutions and way of life.

Russian literature has always been the mirror of the Russian life and mentality. It has also demonstrated its genuine internal ‘agreement’ with philosophy. In the words of the outstanding Russian philosopher

S. Frank, the most profound and significant ideas were expressed in Russia not in systematic academic writings but in a completely different form – in literature, and especially, in poetry<sup>2</sup>.

Dmitri Merezhkovsky once said that the power of Russian intellectuals is not in intellect, but rather in the heart and conscience. It might be that the most stunning demonstration of that is Feodor Dostoyevsky who is widely acknowledged not only as a great writer but no less as a ‘Russian national thinker’. Russian poet – metaphysician of the Silver Age Vyacheslav Ivanov wrote about Dostoyevsky: “He is a great initiator and pre-determinator of our cultural complexity. He made complicated our soul, our faith, our art”<sup>3</sup>.

Berdyaev defined the line led from Dostoyevsky as central to the Russian thought of the beginning of the 20<sup>th</sup> century in Russia. The new idealistic and religious trends which had severed their ties with positivism and materialism of the Russian radical intellectuals were under the sign of Dostoevsky. Rozanov, Merezhkovsky, Bulgakov, Shestov, Andrey Beli, V. Ivanov – all were connected with Dostoevsky, all had been conceived in his spirit. A huge new world that was closed to previous generations has been opened. The era of “dostoevchiny” takes its start in Russian thought and Russian literature.

Dostoyevsky managed to see and understand that in the new era of mass disasters Evil declared itself as Good thus substituting Divine purpose for mankind. Dostoevsky showed the level of evil to which man is capable to fall. This level was boundless, putting philosophical thought on the new test, demanding from it to explain the reasons and limits of evil in human nature.

In the words of Dostoevsky, there are “two folk types of the entire Russian people in their whole”. He claimed that the most striking Russian national feature is first and foremost the oblivion of all measurements throughout, the need to run out over the edge”<sup>4</sup>.

---

<sup>2</sup> Frank, S. The Russian World View, in: *S. Frank. The Russian World View*. Saint-Petersburg, 1996, p.163 [in Russian].

<sup>3</sup> Ivanov, V. *Grooves and Edges. Esthetic and Critical Experiments*. Moscow: Tovarishchestvo tipografii A.I. Mamontova, 1916, p. 7 [in Russian].

<sup>4</sup> Dostoyevsky, F. *Writer’s Diaries.1877*, in: *Collection of Wrings in 30 volumes*, Vol. 21. Leningrad: Nauka, 1980, p. 37 [in Russian].

Dostoevsky by claiming that keeps in mind not only the political radicals whom he calls **Demons (Besy)**, but the intellectuals like Leo Tolstoy who with his views on religion and his religious philosophizing comes up with a unique and unprecedented, unthinkable audacity and “rushes into the abyss with full consciousness of self-righteousness, with the hope that this is worthy of every thinking man”. Tolstoy’s ‘radicalism’, in fact, manifests widely spread people’s worldview.

Thus, the unprecedented audacity is also a Russian mental property. But if “below” (in the case of demons – revolutionists, radicals) this audacity acts like a wild naughtiness, and intentional temptation, threatening to eternal death, as the blasphemy, on the “top” (in case of Tolstoy) it is a conscious religious thinking, a kind of manifestation of freedom of conscience.

The names of Dostoevsky and Tolstoy are well known all over the world while Nicolay Leskov whom Leo Tolstoy called as “the most Russian of all the Russian writers” and Anton Chekhov along with Ivan Turgenev considered as their teacher has not got that well-deserved recognition.

Leskov did not try to “measure the abyss”, like Dostoevsky, he wasn’t trying to revise the foundations of faith, like Tolstoy, he didn’t set itself the task of a myth-making or a prophecy. He was “writing all sorts of things” which in the long run “made a self portrait of a Russian man, a unique self portrait of the nation”.

It took almost a century since the death of Leskov to find his proper place in the Russian culture, to outline his role, his dimension that never came neither to his critics nor to the apologists. In our days Leskov is evaluated as the creator of the capital types representing not just general character of his contemporaries, but discovering far-reaching, underlying, fundamental features of the Russian national consciousness. It is in this dimension that he is perceived nowadays as the national genius.

Short stories and novellas written by Leskov in spite being very dissimilar and written about different themes are united by the ‘Thought’ (Duma) about the fate of Russia. Motherland is presented in a complex mix of contradictions, as squalid and prosperous, powerful and powerless at the same time. In all aspects of national life Leskov is looking at

the heart of the whole. And finds it more often in unusual strange men who are named in Russian as the *chudaks*, those, who behave mysteriously or strange. Here Leskov is in full tune with Dostoyevsky who in his **Karamazov Brothers** said that *chudak* is not necessarily particular, exclusive. On the contrary, sometimes it is precisely *chudak* who holds in himself the core of the whole.

The story **Enchanted Wanderer (Ocharovanny strannik)** is the most ‘emblematic’ product of Leskov. By the number of publications it is far ahead of other masterpieces of Leskov in our country and abroad. This is the epitome of *bogatyrstva*, a hero of the epic in the best and highest sense of the word. This is a work with a vivid symbolic assignment, with a monumental character in its center who impersonates a new historical stage in the development of national character. It is a wide meditation of the writer over the fate of Russia and naturally original force of its people.

In the sense of the wealth of the plot it is perhaps the most remarkable work of Leskov. It is particularly conspicuous by absence of any centre. There is no plot, strictly speaking, but there are a number of fabulas, strung like beads on a thread, and each bead exists in itself and can be very easily to be handled, replaced by another, but then you can have as many beads on the same thread as you wish. (Nikolai Mikhailovsky)

What is the meaning, the purpose of these bizarre, scattered wanderings? Some will see in that the sign of decay and aimlessness. The others will perceive a variety of options of destiny. (B.Dyhanova).

The elements of *bogatyrstva* and of folk epic are introduced by Leskov so that to put in a landmark the differentiation, if not an opposition, between ‘us’ (the Russians) and ‘them’ (the foreigners). Thus, in **Iron will** there is a stunned German; in **Enchanted Wanderer** the Russian Vityaz competes with an English professional to control the horse. Nothing helps to Mr. Rareu, neither his expertise nor his special armors. He is dropped by the horse and confounded while our hero tames a savage animal. In **Left Handed (Levsha)** another Englishman will be confounded by another Russian folk master by his capability in repairing a clockwork flea though in the long run the flea, as a result of that repair will ‘forget’ how to dance.

The above said ‘opposition’ is used not for the purpose to cut Russia from the West; it is not aimed to make out of the westerners the enemies for the Russians. In every story there is recognition that the level of living in the West is much higher than in Russia, that the people there have better social conditions for their existence due to the different social and political order they managed to get, due to ‘labor ethics’ – fully unknown to the Russians in their attitude to the work which is to be done. Yet Leskov’s narratives do not lead the readers to the conclusion that Russia should make its final choice in favor of the western way of life. On the contrary the heroes of his writings (who always represent not the Russian elite but the common people) demonstrate some features of excellence either in morals or in professional skills which they got not from learning and training but as a self-taught expert. What does then the writer wishes to say by that? It looks like his intention is to remind the compatriots that they do have their own ‘treasures’ which are to be saved and not to be substituted by blind borrowing from the others. Our guess is fully justified by the very title of one of his short stories named as “Foreign ways of life could be used only reasonably.”

This forewarning sustains its validity up to nowadays. What are the most important reasons of its special meaning for modern Russia?

There is quite evident that the future of global world order is unclear: there are possibilities of different scenarios. Many Russians cherish hope for the return to the status of a superpower which the Soviet Union, along with the United States, had in the past century. Others are alarmed that globalization poses a real threat to what they call “the Russian civilization”. There are also those who expect Russia to become one of the poles in a multi-polar world.

Which of the above scenarios is real and desirable? Let's start with the first one. Among the superpowers in the past there were Ancient Egypt, the Empire of Alexander the Great, and the Roman Empire. History proves that, once having lost the role of a superpower, none could ever get it back. However, the Russians often are inclined to believe that their country is predestined to a particular mission. This conviction is deeply rooted in their historic memory. After the fall of Constantinople the Russian church strongly promoted the idea of being God chosen guardian of Christian teachings in its purity. The Russian monarchy

called Moscow as the “Third Rome” and stated that there will not be ever replaced by the Fourth Rome since the Russian Kingdom will stand until the end of the world. Later, after the revolution of 1917, the Soviet authorities actively promoted the messianic role of the USSR in the liberation of the humanity from exploitation and inequality: the old world will be destroyed down to the ground, and then, we shall build a new world. Nowadays some of those who are well aware that in the near future the leading role of Russia as a military and economically strong power is unreal still are hoping that it could play the role of a spiritual guidance.

The Russian Orthodox Church supposes that, just as the United States formulated its mission as a community of freedom, “overriding mission of Russia could be defined as upholding the Truth in the world”. It provides an enhanced understanding of the word “Truth”, which includes the notions of truth, justice, righteousness. The above mentioned values are unquestionable; however, there are at least two questions. First, are not these very values universal? And secondly, to what extent are we following the declared values? Let us take the most concrete and understandable to everyone value like “strong family”, “equity” and “caring about the environment”. Compare them with publicly available statistics and daily news events so that to make sure that none of these values is in fact characteristic of the modern Russian life. On the contrary, the departure from them is accelerating on a large scale. In order to carry the mission in relation to the others, one must first follow ideals by oneself and demonstrate the progress in their implementation.

It should be remembered that the real status of superpowers the Soviet Union and the United States obtained during the cold war time due to the splitting up into two camps in which those two countries hold dominant military supremacy. Consequently, the USSR stayed as a superpower from 1945 until 1990. Forty-five years in comparison with a thousand-year period of Russian history is such a small period that it would be justified to admit: “There has not been any long aged tradition of being a superpower. There is only a habit to think like that and there is the memory shared by the two generations which was passed to their children, grandchildren, and grand- grandchildren”.<sup>5</sup> The return to the

---

<sup>5</sup> Spassky, N. The Island Russia, in: *Russia in the global politics*. Moscow, 2011, Vol. 9, № 3, p. 29 [in Russian].

status of a superpower would not mean a return to a tradition, but rather a restoration of “the cold war”, in which the position of the USSR as a superpower became possible. Swivel reverse history is impossible, and the efforts to implement that are disastrous.

The second scenario which involves the loss by Russia its identity is equally dubious. We are sheltered from it by the vastness of the territory, the geopolitical location between the East and the West, virtually inexhaustible natural resources, large number of high educated people, truly rich cultural heritage.

Indeed, more realistic and more desirable is the third scenario: to become the country of welfare for its citizens, a State which would be taken into consideration by the others in determining world politics. The preference for selecting this scenario is manifested by recent sociological research. The question posed in 2010 by Russian sociologists: “What do you prefer: a good life in a normal country or the life in a military super-power?” The Russians choose the first. To become a wellbeing State for its citizens and at the same a State with which would be considered in determining the course of world affairs is not an easily achievable task.

To change radically its economics, to raise the standard of living of the citizens is possible only with a high level of modernization. The question, however, is what model should be chosen? This question is not new for Russia. In the 19<sup>th</sup> century, the Russian society was divided so that some, like Peter Chaadaev, were convinced that “you cannot be civilized without following the European model”<sup>6</sup>, while the others insisted: the main task for Russia is not to become dependent from the West, to safeguard its particularity (Konstantin Leontiev).

One cannot expect successful economic development and prosperity in an atmosphere of “moral wildness” which is manifested in cynicism, in the crisis of collectivism, in loss of family values (increase in the divorce rate, orphanage, etc), in large scale violence and crime, in distrust of the State and its institutions. In addition, rapid and effective modernization implies a collective motivation.

---

<sup>6</sup> Chaadaev, P. *Philosophical Letters*. The 1st letter, in: *P. Chaadaev, Works*. Moscow, 1989, p. 28 [in Russian].

In 2005, the Russian researchers were requested to build up a cultural-specific methodology of the study and interpretation of the structural values of the Russian culture, as well as to identify the dynamics of the structure of the underlying values of Russians, its influence on economic and social behavior of the Russian citizens.

The values shared by two generations of the Russians (students and their parents) in various regions of Russia were measured. The measurements have shown that the value structure shared by Russians during the period from 1999 to 2005 was stable in maintaining the seven most important factors that determine the value of motivation: security; self-realization; simplicity (modesty, satisfaction with own place in the life, commitment, ability to forgive, moderation, mutual assistance, honesty); spirituality (unity with nature, love of beauty, spiritual life, environmental protection, courage, creativity, loyalty); hedonism; domination (willingness to move forward using all means, even on the heads of others); harmony (internal harmony with oneself, self-respect, right to privacy, along with a sense of social identity).

There is no doubt that the above values are important for successful economic development. However, it is equally obvious that they are less noteworthy than those values from which they derive. They are derivative, belonging to what is called “Thin culture” which has its roots in the past. But this does not preclude its dynamic, constructive nature. The values of “Thin culture” are empirical; they occur in response to socio-economic changes<sup>7</sup>.

Thick is the fundamental nature of culture: cultural meanings are rooted in history, deeply embedded in social institutions and practices<sup>8</sup>. Thick culture is given. It precedes and produces both the institutions and practices.

The efforts to identify the core of Russian culture, hence of the national character, were taken many times. One could make the full list of examples that confirm the difficulty of determining what con-

---

<sup>7</sup> See: *On Culture, Thick and Thin: Toward a Neo-Cultural Synthesis* / Ed. by William Mishler and Detlef Pollack. Chapter 13.

<sup>8</sup> See: Geertz Clifford. *The Integrative Revolution: Primordial Sentiments and Civil Politics in the New States – Old Societies and New Societies* / Ed. by Geertz, C. N.Y., 1963.



stitutes the nucleus of Russian nature and its culture. In the report entitled “Russian national character” which was made at one of the philosophy conferences in Rome in 1923 by B. Visheslavtsev (1877–1954) it was said: “We [the Russians] are interesting, but incomprehensible for the West and perhaps, therefore, are especially interesting. Even we do not fully understand ourselves, and perhaps incomprehensibility, the irrationality of actions represents some feature of our nature”<sup>9</sup>.

Much easier to understand the values related to peripheral sectors, i.e. to “Thin culture.” Though these values are often constructed from the above, by those who hold power, they have a huge (if not critical) impact on the development of the society as a whole. Such a “construct” was the triad: “Autocracy, Orthodoxy, Narodnost (Patriotism)”, which under Nicholas I (1825–1855) become the ideological doctrine of the Russian Empire. Paradoxically, the October revolution of 1917 which radically changed all the sides of the social life and destroyed its ideological pillars, however, failed to “uproot” them completely. Hence the previous “pillars” were replaced by the “new” that grew up from the rhizome of the old roots. Christian orthodoxy was replaced by the dogmas of Marxist-Leninist ideology; Autocracy – by Communist dictatorship; Narodnost – by Soviet patriotism.

At the beginning of Perestroika its proponents tried to forward as a national idea the building of “socialism with a human face”. A few years later, at the official level, it was stated that the ideology (and thus a common national idea) was redundant, in fact, harmful. Soon, however, the “search for the national idea” started once again.

From time to time the claims are made that the national idea has been found. Thus, former Deputy Prime Minister Sergey Ivanov optimistically declared that “Russia has completed the arduous, ongoing since the early 1990’s, the formation of a new system of values that define the intellectual prop-based society in the coming millennium. For the first time since the proclamation of the new Russia, we have been able to articulate a clear answer key for all of the people and the State questions: Who are we? Where should we go? In what society we want to

---

<sup>9</sup> See: Visheslavtsev, B. The Russian National Character, in: *Voprosy Filosofii*, 1995, № 6, p.113 [in Russian].

live?”<sup>10</sup> The respond to the above said questions make the triad of national values is the triad: “Sovereign democracy, strong economy and military power”.

Of course, the word “value” is polysemous. It can, for example, mean a market value – the price of the goods, or a pragmatic value – practical relevance of one or another political action. But it isn’t this kind of values which is taken into consideration when it comes to the “national idea”.

It is true that the Russians are concerned about the political status of their state; they wish to live in an economically prosperous country without fear for safety. But, as evidenced by the results of opinion polls, the Russians are most concerned about “loss of moral values, immorality”<sup>11</sup>.

Pragmatic calculation, whether material or political, is able to bring together groups of people interested in practical benefits. Yet it is unable to serve the cause of national reunification around inspirational ideas, principals, and ideals. That requires ethical motivation, which may be formulated only on the basis of the national cultural heritage, taking into account the requirements of the new time.

Equally striking is the claim that this triad makes a “special ideological project, competing for the right to determine the global agenda and further prospects of the entire humanity”. Actually that is a claim for the Russian “Imperial project” of globalization, which affirms the hegemony of the strong.

The ability to determine the prospects of the development of mankind depends only partly on economic and military power. Russia is in a position to engage positively in the processes that shape the world, only maintaining its own “face”. Is it possible at all? If so, what could be

---

<sup>10</sup> Ivanov, S. The Triad of National Values, in: *Izvestija*, № 124, 13.07.2006, p. 4 [in Russian].

<sup>11</sup> The survey was conducted before the G8 summit by the international agency “Eurasian Monitor” and by the company “Global Market Insight” (GMI). The question was: With what menaces are you concerned most of all? And here is the statistics of answers from citizens of Russia:  
The spread of terrorism – 54 %  
The loss of national specificity and traditions – 39 %  
Mass unemployment and impoverishment – 44 %  
The loss of moral values, immorality – 59 %.

the ways of achieving that aim? Should Russia at last put the end to its staying on the cross-road between the West and the East? My answer to this question might sound to many as a wrong one or paradoxical. It can also look as fully identical to the views of Nicolay Berdyaev expressed in his originally published separately as a pamphlet named **The Soul of Russia (Dusha Rossii)**<sup>12</sup>. Actually I agree with the first part of N. Berdyaev's assertion that "Russia cannot define itself, as East, and thus oppose itself to the West. Russia ought to conceive of itself as also West..." Yet I disagree with what he says in the end of the same sentence: Russia ought to conceive of itself "as an East-West, an uniter of the two worlds, and not a divider." To me that statement sounds as a concealed claim for a special hegemonic mission of Russia. Nobody is in a position to "unite" the two worlds which are actually different civilizations. To me even to assert that Russia should be "a bridge between East and West" sounds quite pretentious. I would rather be in consent with another great Russian – Petr Chaadaev who wrote in his **First Philosophic Letter** that holding place between the two poles – the East and the West – Russia should take advantage of that geographic position by bending from one side on China while from the other side – on Germany and thus learning the wisdom from the two civilizations – both Eastern and Western.

"Staying on the cross-road" gives something even more valuable. It is precisely that position that brings the uncertainty with the choice, permanent fluctuation affecting the Russian culture. The "enigmatic contradiction with Russia" is rooted not in the disunity of the masculine and the feminine within the Russian soul and the Russian character, as Nicolay Berdyaev believed. It is determined by everlasting work of its soul and consciousness. Once the final choice is made that uniqueness will be lost, Russia will end to hold its own face, its identity.

It is true that the metaphysic questions are "doomed to defeat" (Buddha, Kant), and yet we ought to continue asking them.

---

<sup>12</sup> Berdyaev, N. A. *The Psychology of the Russian People*. The Soul of Russia. Transl. by Fr. S. Janos, 2008.

## VII. STUDENTS' PAPERS

I. Shchedrina

### THE PROBLEM OF THE “SELF” IN THE EUROPEAN TRADITION: CASUS OF MALEBRANCHE<sup>1</sup>

In modern philosophical and scientific-humanitarian research the “self”-problem is becoming more and more actual and creates one of the key themes of contemporary philosophical reflection. The scopes of this problem vary – from the subjects of self-identification in the philosophical-epistemological context up to personality, subjectivity – in the historical-philosophical context. I think that for the deepest penetration into the meaning of this problem it is necessary to go back to its origins, that is, first, to the problem statement of “self” in the epistemological context and, second, in the historical and philosophical perspective: in the Cartesian tradition in the face of Malebranche.

As is well known, Nicolas Malebranche got inspired with the ideas of Descartes, in a rather mature age (26 years). And, perhaps, that is why in the process of mastering them, he turned his studies in their entirety. As Hegel tells us in “Lectures on the History of Philosophy”: “In passing a bookseller’s shop he <Malebranche> happened accidentally to see Descartes’ work *De homine*; he read it, and it interested him greatly – so much so that the reading of it brought on severe palpitation and he was forced to cease. This decided his future life; there awoke in him an irrepressible inclination for Philosophy”. Following Descartes, he brought his ideas to the full clarity. And thus, trying to overcome them, Malebranche clearly demonstrated the inner complexities of the Carte-

---

<sup>1</sup> This article has been prepared with the financial support of the grant RFH No. 13-33-01259.

sian method of resolving of doubts, and therefore Cartesian approval of “self” as “self” existing. I think, meantime, these are the difficulties Malebranche experienced, developing the Cartesian settings, that make the ideas of Descartes the effective screen to reveal the problematics of “self”, actual for today.

In his work “Dialogues on Metaphysics” (1688) Malebranche discusses the substantiality of the soul, stating the position of Descartes: “I think therefore I am”<sup>2</sup>. Trying to answer the question “what is the nature of the thinking “self”?” Malebranche analyzes the concepts of “substance” and “mode”, relying on the Cartesian definitions. Descartes wrote: All we can mean by “substance” is thing that exists in such a way that it doesn’t depend on anything else for its existence”<sup>3</sup>. Mode in fact is essentially secondary and can not exist without the substance, on its own. So, Malebranche says, it is necessary to find for each thing what can not be thought of without. I stress – thought, and so, in the Cartesian tradition – to be.

As evidence Malebranche in “The Search after Truth” gives an example: a circle can not be thought of without idea of extent, extent can be thought of without resorting to the idea of a circle or any other thing, but they all come to spatiality, as opposed to non-spatial categories. Further, we can conceive these non-spatial categories (our feelings, thoughts, perceptions and sensations) directly, i.e. with no idea of extent, and that evidences of their independent substantial nature. This happens in case we want to conceive “Self”, i.e. we can think about “Self” not resorting to the concept of extent. Thus, Malebranche goes after Descartes, allowing two substances – corporeal and thinking, the correlation of which becomes one of the main issues. But at the same time, unlike Descartes, Malebranche does not see the need to appeal to doubt, so that the question itself in this case, first, loses the epistemological parameters, and, secondly, implies a different kind of effort – not the effort of thought, which, overcoming doubt, draws the world of things in thought and makes it available to “Self”, but only the effort of faith.

Thinking “Self” is locked in one of these substances, the other one is out of the very thinking process, and with this *res extensa* all meaningful wealth of the world, which “self” is thinking of and trying to con-

---

<sup>2</sup> Malebranche, N. *Entretiens sur la métaphysique et la religion*. Paris, 1922, p. 26.

<sup>3</sup> Rene Descartes. *Principles of Philosophy*. Cit. by: <<http://www.earlymoderntexts.com/pdf/descprin.pdf>>.

ceive, turns to be out. And, following Augustine, Malebranche in the “The Search after Truth” believes that “He <God> is our only teacher, managing our spirit, according to St. Augustine, without the mediation of any creature”<sup>4</sup>. Moreover, later I will give the discourse of Malebranche that even the attempts to conceive the states of our souls are external to our “self”. For, as Hegel wrote in “Lectures on the History of Philosophy”, describing the ideas of Malebranche, “I and the thing are clearly independent of one another and have nothing in common”. Descartes, discussing the relevance of the substantialistically opposing *res cogito* and *res extensa*, admitted a liar, turning this correspondence of substances into the problem and assuming the thinking thought effort of a human to solve it. Nativism of Descartes, in my opinion, is associated with the same, i.e. with Descartes’ desire to leave, so to speak, a place for the power of thought. God, according to Descartes, “put” some of the ideas in the head of a man, and that ensured that they are true, but the unfolding of them in thinking, that is, in fact, the retraction of the world of things in thought, was performed by the man himself, on his own risk, with errors and most importantly, with doubts, the overcoming of which led back to “I”.

Malebranche doesn’t need the idea of a liar, believing that God himself has established this correspondence. But to finally break out of Cartesian “I” finally closed by him, where existence and essence coincide so much that the world of things turns out to be out of that “I”, Malebranche has to accept the premise of God who creates things continually and continually supports their existence. In other words, the force of thought, which construes the world according to Descartes, Malebranche shifted to God. It is noteworthy that when Descartes began to prove the existence of God and the distinction of the soul from the body by “geometric method”, he was already relying on the thesis that “I am, therefore I exist”. Descartes showed with his reasoning the ability to justify God as the first principle, opened the way to Malebranche, who claimed that the most reliable evidence of God – the ontological: “If God can be thought of, he must exist. Another creature, though, can be conceived, but can not exist. It is possible to conceive his essence without his existence, his idea without himself. But it is impossible to

---

<sup>4</sup> Malebranche, N. *The Search After Truth*. Saint-Petersburg, 1999, p. 288. (transl. from Russian) [in Russian].

conceive the essence of the infinite without its existence”.<sup>5</sup> And the doubt is replaced by faith. It should be noted that postulating the directness of conceiving of God, without the mediation of any creature”, he also follows Augustine, who in his treatise “On True Religion” (Ch. 55) wrote: “So, let the religion bind us to Only one almighty God, because between our mind we perceive the Father with and the Truth, that is, inner World, by which we conceive him, no creature can mediate”.

I do not find it necessary to give here a more detailed justification for the existence of God in Malebranche. There are two important points for me.

First, appealing to Augustine, Malebranche justifies the existence of the world by the continuous act of creation, i.e. entity is determined by the existence of the divine will. By the same token thinking I and the world of extended things – both of these substances are immersed in a kind of unified field of divine effort, and as it were relate to each other in it. The same course can be found in Berkeley, who in his “A Treatise Concerning the Principles of Human Knowledge” (§ 29) stated: “... whatever power I may have over my own thoughts, I find the ideas actually perceived by Sense have not a like dependence on my will. When in broad daylight I open my eyes, it is not in my power to choose whether I shall see or no, or to determine what particular objects shall present themselves to my view; and so likewise as to the hearing and other senses; the ideas imprinted on them are not creatures of my will. There is therefore some other will or spirit that produces them”. I should note that the Berkeley’s stipulation “ideas <...> have not a like dependence on my will” let him deny the similarity of his views with the teachings of Malebranche about “the vision of all the things in God”. In “Three Dialogues between Hylas and Philonous” he declares it openly: “I shall not therefore be surprised if some men imagine that I run into the enthusiasm of Malebranche; though in truth I am very remote from it. He builds on the most abstract general ideas, which I entirely disclaim. He asserts an absolute external world, which I deny. He maintains that we are deceived by our senses, and, know not the real natures or the true forms and figures of extended beings; of all which I hold the direct contrary. So that upon the whole there are no Principles more fundamentally opposite than his and mine”. Berkeley even argued with Malebranche personally. A few days

---

<sup>5</sup> Malebranche, N. *The Search After Truth*. Saint-Petersburg, 1999, p. 288 [in Russian].

before Malebranche's death Berkeley has visited him. Being very weak Malebranche was not receiving visitors, and the famous philosopher had to strive for an appointment for a long time. Their conversation, too lively and passionate, it is said, caused the worsening of Malebranche's health condition and quickened the death. Malebranche died on the 13<sup>th</sup> of October, 1715. However, in the special historical and philosophical study the correlations between the ideas of Berkeley and Malebranche have been established<sup>6</sup>.

Secondly, the "I" itself here has being only in God, and therefore is given to itself not in self-consciousness, but only in the act of faith. God is not only a guarantee of consistency between the *res cogito* and *res extensa*, but also the true substance embracing them, which "I" is not able to conceive in its fulness.

Describing the paths of cognition (guaranteed by God), Malebranche in "The Search after Truth" writes about four different ways of contemplating of the thing. "The spirit contemplates all the different objects of its cognition" (Book III, Part II. Ch. 7). Malebranche distinguishes:

- 1 – cognition of the things through themselves;
- 2 – cognition of the things through ideas (through something different from them);
- 3 – cognition with consciousness or inner sense;
- 4 – cognition through the assumptions.

In the first case things appear intelligible themselves since they effect the mind directly, opening to it by this way. If things are not intelligible – and these are all corporeal things, they are conceived by us through ideas. With consciousness we conceive something "inseparable from ourselves", our states of soul. And "finally, by supposition can be conceived all the things are learned, different from ourselves, and from the things being conceived through themselves, or through the ideas, such as: when we think that these things are like some other, unknown to us".

In the process of analysis of all these ways of cognition clearly emerges Malebranche's thought that only one God (not one's own I) we conceive through himself, the material world is not revealed to us directly – cog-

---

<sup>6</sup> See: Luce, A. A. *Berkeley and Malebranche. A Study in the Origins of Berkeley's Thought*. New York, Oxford, 1967.



niton is either by analogy or through ideas, etc. Moreover, we can not really conceive even the soul. Malebranche writes: “With consciousness or inner sense that we have of ourselves, we come to know enough that our soul is something great, but it well may be, that what we know about it, has almost nothing to do with what that it is in itself <...> Therefore, to perfectly know the soul, is not enough to have what we learn about it with one inner sense, because the consciousness which we have of ourselves, perhaps, reveals only the smallest part of our being” (Malebranche N. “The Search after Truth”, Book. III, Part II. Ch. 7). So Malebranche carries to logical completion Descartes’ idea of “self”.

## **THE ANNALES SCHOOL IN THE CONTEXT OF EUROPEAN PHILOSOPHICAL-METHODOLOGICAL TRADITIONS<sup>1</sup>**

New historical School, better known as the “Annales”, appeared in the 30-ies of the 20<sup>th</sup> century, when the historical science in Europe was going through a crisis. This period was a replacement of classical “history-narrative” and “history-problem”. The historians of that time started to put in the center of their research not the activity of great people, not the empirical description of the events and political institutions but human subjectivity in all its forms: from the economic to the social-political connections and relationships. This approach was not accidental for European intellectual tradition. Moreover, the Annales school could arise only in European philosophical tradition, that is, in such an intellectual atmosphere where the following issues were discussed: the autonomy of the cultural sciences (Rickert), the role of speech as a sign of the message (Dilthey, Heidegger, Shpet), the problem of meaning and the act of understanding and comprehension of meaning (Brentano, Husserl), the problem of psychology in human cognition (Bergson, Husserl, etc.), etc. Although it is quite difficult to define the direct influence of philosophical tradition in the methodology of the Annales school, yet it is possible to reconstruct certain intellectual consonance with the philosophical problems mentioned above.

First, we can find intellectual consonance of the Annales school with the ideas of philosophical hermeneutics, the center of which is a problem of comprehension of meaning (including the problem of understanding

---

<sup>1</sup> This article has been prepared with the financial support of the grant RFH No. 13-33-01259.

of the historical texts). One of the first representatives of the Annales school – Lucien Febvre in the book “A new kind of history” critically treats the thesis, which became the determination of historian’s activity at the beginning of the 20<sup>th</sup> century: “history is learnt by means of texts”<sup>2</sup>. This criticism is aimed primarily at university historians. “If we remember that aiming to teach them [students of the Faculty of History] to recreate the image of the past <...> universities do not require from their alumni even the critical understanding of the text, but teach them to pay off almost exclusively with words – dates, names of historical figures and the names of localities – if we remember all this, there is no doubt, we will understand the essence of the formula “history is learnt by means of texts”<sup>3</sup>. And further: “The story to which we are accustomed, was, in fact, the deification of the present by means of the past. But it did not want to see it, did not want to admit it”<sup>4</sup>.

Second – but not the least for us today – consonance takes shape in the process of comparing the methodological principles of the Annales school with a tradition of the methodology of the human sciences, namely, with the concept of Dilthey, with his thoughts about the specifics of these sciences – to return to the subject of historical cognition of concreteness. Febvre, like Dilthey, criticizes excessive positivity of the historical science of that time. He defines history as the science of man, of the past of the mankind and not of the things or phenomena. “Can there be ideas independent of the people who profess them? After all, the ideas are just one of the components of that mental baggage, formed by impressions, memories, readings and discussions, which every one of us carries. So is it possible to separate the ideas from their creators who, without ceasing to treat them with greatest respect, constantly transform them? No. There is only one history – the history of Man, and this is history in the broadest sense of the word”<sup>5</sup>.

To return concreteness to the subject of the historical process avoiding psychologism the representatives of the Annales school introduce the concept of “mentality”. Analyzing the works of the representatives of this school we can see that the elements of mentality are different in

---

<sup>2</sup> Febvre, L. *Battles for history*. Moscow, 1991, p. 12 [in Russian].

<sup>3</sup> Ibid. P. 13.

<sup>4</sup> Ibid. P. 15.

<sup>5</sup> Ibid. P. 20.

their grounds as they are both within the conscious and the unconscious and because the formation of mentality is influenced by economic activity, socio-cultural environment and nature environment. So, each time in the base of synthesis, in which the historian literally “lights up” man of the past, we can find different factors – from psychological to quite objective-material. In this sense, the concept of mentality can not claim to be the universal methodological basis of historical synthesis. But the task of historical science is still in the fact that the historical memory becomes not just a set of facts, but the source of vital force that ensures the continuity of culture and that is the basis for the development of society in changing conditions. In this sense, the concept of mentality, developed at the Annales School, performs this task.

The third intellectual consonance can be found in the process of writing the methodology of the Annales School with the tradition of neo-Kantian methodology of humanities. First of all with the ideas of H. Rickert. This is particularly evident when Febvre tries to deal with the issue of anachronism that haunts all the historians. This problem can be formulated by neo-Kantian thesis subject matter of principal reconstructibility of the humanities subject, which is used by A. Y. Gurevich, the representative of Russian Annales School. In the book “Historical synthesis and the School of Annales” he writes: “Whatever history “really was” we can not know; while reconstructing history, we are constructing it. We can observe it from the present and, therefore, add to its picture our view of the history, our understanding of its continuity, our own value system”<sup>6</sup>. These thoughts are in tune with the position of Febvre, who emphasizes: “Man does not remember the past – he is constantly recreating it. This also applies to such abstraction as a single person. And such reality as a man who is the member of society. He does not keep the past in his memory just as the northern glaciers thousands of years keep in its strata frozen mammoths. He comes out of the present – and only through the prism of the present he conceives and interprets the past”<sup>7</sup>. The historian should seek to reconstruct those intellectual procedures, skills of consciousness, ways of perception of the

---

<sup>6</sup> Gurevitch, A. *The Historical Synthesis and École des Annales*. Moscow, 1993, p. 12 (transl. from Russian) [in Russian].

<sup>7</sup> Febvre, L. *Battles for history*. Moscow, 1991, p. 22 (transl. from Russian) [in Russian].

world that were inherent in the people of this epoch and in which they did not give any clear report, using them somehow “automatically”, without thinking and without exposing them to criticism. This approach enables us to break through to a deeper layer of consciousness, intimately linked with the social behaviour of people, to “overhear” what these people “blurted out” – regardless of their will.

This approach presupposes the most careful study of the vocabulary of the epoch, as well as symbolic actions inherent in the people. And here we have the consonances of the Annales School with the traditions of philosophical semiotics rooted in conceptual directives of Augustine. In the area of attention of historians should be the “signs” of a man, “everything that is concerned with a man, depends on a man, expresses him, indicates his presence, activity, tastes and ways of human existence”. It is necessary to “make the dumb things talk as they can tell us about their creators the things they do not tell about themselves – in this constantly renewable attempt should be the most important and certainly the most exciting aspect of our historical craft”<sup>8</sup>.

That is why Febvre paid a lot of attention to the problem of correlation between history and psychology. Historical knowledge has always been the most important aspect of self-consciousness of society: to understand ourselves is possible only in a historical perspective, moreover quite deep and wide, in comparison with the others – with the people who belong to different civilizations, to the epochs gone by.

The representatives of the Annales School do not have clear subject and methodological directives, which they adhere to during their research. Philosophical-methodological arsenal of the school was constantly modifying. In its base there is the synthesis of different philosophical views. From positivism the Annales adopted thoroughness in the analysis of historical facts. Similarly, as Bergson denied the existence of a frozen structure of the human personality, presenting it, rather in the Heraclitean style as something living, something you can not catch twice in the same state, the representatives of the Annales school did not perceive the mentality of the people as some kind of constant. The historians of the Annales School were trying to figure out what

---

<sup>8</sup> *Combats pour l'histoire*, Paris, Armand Colin, 1953, 456 p. Cited by: Gurevitch, A. *The Lessons Of Lucien Febvre*, p. 509 (transl. from Russian) [in Russian].

really moved the history, examining the cultural-historical consciousness (mentality). They took methodologically extremely successful attempt to give a deeper, more holistic view of the historical reality. Their works are very interesting to read, they are full of the specific content, synthesized on the base of mentality concept with the help of interdisciplinary approach. In the research of historical memory made by the representatives of the Annales School the concept “mentality” has a distinct methodological construction. The synthesis of the different sciences – history, psychology, sociology, linguistics – is able to show us a complex picture of the world of the past, make us feel the spirit of time. This is possible thanks to the reconstruction of history, the identification of human representations of a particular epoch, its ways of perceiving the world. You can probably say that they, being rooted in European intellectual tradition, made a new step towards a more comprehensive understanding of the human history.

**RATIONALISTIC DOUBT OF DESCARTES  
AND MONTAIGNE'S SKEPTICISM AS THE BASIS  
OF HORKHEIMER'S CRITICISM<sup>1</sup>**

The Frankfurt School started from the moment when Max Horkheimer took the post of the director of the Institute for Social Research. On the 24<sup>th</sup> of January, 1931, he delivered a speech “The Present Situation of Social Philosophy and the Tasks for an Institute of Social Research” in which he outlined a new direction for scientific activity development, implying a change in the methodology of social-philosophical research. This school implements its critical functions in the reflection of the social conditioning of all the concepts, theories, forms of knowledge it comes across. In many ways this is why the critical theory (both from the point of view of its founders and from the point of view of the researchers) has the significant advantage over other approaches – that its development takes place taking into consideration the reflection over its cultural-historical tradition.

1934–1939 – the period when Horkheimer came to the conclusion that it was necessary to reconsider the approach to historical-philosophical tradition. At this time he was under the influence of R. Descartes, his rationalistic “method of doubt” and M. de Montaigne (his skepticism). He himself stated these influences and devoted the articles to Descartes and Montaigne. But the question arises: how methodological doubt of Descartes and personal skepticism of Montaigne entered Horkheimer’s “critical theory of society”.

---

<sup>1</sup> This article has been prepared with the financial support of the grant RFH No. 13-33-01259.

To this issue Horkheimer dedicated his article “The Rationalism Debate in Contemporary Philosophy”<sup>2</sup>, written in 1934. Cartesian rationalism, according to Horkheimer, presupposes the constant correlation of the concept and reality. Moreover, this correlation is understood by Descartes rather abstractly, beyond socio-political reality. However, it is Descartes that turned a doubt into the most important element of thinking about the world. Descartes himself, in his work “Rules for the Direction of the Mind”, calls for the deal to only “those subjects about that our minds are obviously able to achieve reliable and genuine knowledge”. This rule he substantiates with the fact that it is necessary to trust only completely verified knowledge, the doubt in which is categorically excluded, otherwise you can make a mistake by relying solely on externally plausible facts. Descartes creates a particular attitude to scientific knowledge, thereby continuing the tradition of rationalistic philosophy in Europe. For him it is important that science is genuine and obvious knowledge. The achievement of genuineness and obviousness – is the principle upon which any rational research, especially in the field of socio-political studies, is based. Doubt for Descartes is not an end in itself. The true meaning of Cartesian rationalism is to free the human mind from different prejudices. Despite the fact that the quantity of doubts is growing, it is quite possible to find a way to overcome them. Thus, the mere fact of the existence of a doubt becomes the reasoning that the doubter thinks all the time, and therefore he exists. So, Descartes considers it necessary to carry out the search of genuine knowledge in the self-consciousness of the subject, which is based on a permanent doubt. In this case *Cogito ergo sum* acquires the status of an axiom on which it is possible to build the whole edifice of science.

Horkheimer plunged methodical doubt of Descartes in socio-political reality, made it concrete. He himself doubts the method of “doubt” of Descartes, critically rethinks it. Philosophy, according to Horkheimer, should be immersed in life and that requires the dialectical attitude to life and different understanding of thinking. It provides the mind with such qualities as conceptually examining, comparing, explaining and generalizing and, therefore, gives it a special form – the form of critical analysis. Horkheimer states that the dialectical method is the highest

---

<sup>2</sup> Horkheimer, M. Zum Rationalismusstreit in der gegenwärtigen Philosophie, in: *Horkheimer, M. Gesammelte Schriften*. Bd. 3. Clausen & Bosse, 1988. S. 163–221.



manifestation of all the intellectual resources, as it is capable of creating fruitful moments for the worldview of the living subject. At the same time, apparently relying on Descartes, Horkheimer says that each present thinking should be understood as a historical critique of abstract concepts, and that is the skeptical moment. It can be explained by the fact that all separate sciences are only the suppliers of elements that later form the theoretical construction of historical process. Thus, the accuracy of thinking representation of reality directly depends on the accuracy of the incoming elements (the products of analysis), and this accuracy depends on a critical approach to historical sources.

According to Horkheimer, the lack of criticism shows that the analysis is, in fact, converts the concrete into the abstract. The rejection of the historically defined terminology, the birth of abstract conceptual entities, concern about the alleged neutral expressions, and the pursuit of originality take place. But we are not to blame the intellect for that, but its insufficient connection with the historical issues raised. Meanwhile, the attention of rationalism does not escape the individualistic movements, as its psychology, according to Horkheimer, is associated with “personal interests”. He resorts to the criticism of abstract thinking, relying on the opposition of the amount of parts and integrity. This problem is probably the result of the influence of the ideas of Rene Descartes, who managed to bring together the knowledge and doubt, to distinguish knowledge and dogmatic certainty, and to outline the problem of value-conditioning of common sense and empirical positions. According to Horkheimer, it will promote not only economically powerful, but also other sections of the population.

Later, in 1938, a new article of Horkheimer appeared “Montaigne and the function of skepsis”, in which the author raised skepsis (doubt) to the rank of a cultural phenomenon, which, in turn, is reflected in the specific socio-political processes.

One can not but agree with Horkheimer, that skepticism is most prevalent when the society is coming to a certain stage of development, when new social ideals have not yet taken root, and the old considerably loosened. Montaigne is considered to be the founder of modern skepsis, he saw himself as an “innovator of the old”. He believed that skepsis has far-reaching horizon, and deprived it of its limitations. Horkheimer

reveals skepsis as the usual understanding of the world taking into account the lack of confidence to each utopia, coming in the way of the researcher. He believes that skepsis has great potential. Philosophical skepsis is essentially conservative, it protects its followers from destruction. Montaigne sees this as an approximation to the absolutism that is able to guarantee “the preservation of civilian property”. Horkheimer calls skepsis the “quintessence of nominalism”. In his opinion, a skeptical function is reflected in the subjectivity of cognition, which can fit in even the most contradictory systems.

Montaigne reserves for individual special position. Skeptical “Self” does not form a specific idea in the form of a doubt in one’s own existence, but we can assume that it becomes itself, possessing this quality. Horkheimer thinks that “Self” tends to self-confidence and independence, while maintaining its ability to doubt. Freedom, conditional on skepsis, may include only the freedom of the social whole, requiring personal loyalty. This is due to the fact that “Self” is able to save only itself, but this theory seeks to save all the humanity in whole.

Many researchers interpret the skepticism of Montaigne as the most important methodological principle of cognition. Skepticism at Montaigne’s disposal is recognized as methodological approach, an instrument of criticism and besides constructive criticism, which aims to revise the conventional, mechanically inherited from the past, taken for granted copy-book maxims and to develop self-sustaining, independent judgments. Montaigne aims to purify science from false and outdated knowledge, giving way to new discoveries that will bring real benefits to people. But at the same time, according to Montaigne, without thoroughly checking of the facts accumulated by experience it is impossible to establish genuine knowledge: “...there was never wanting in that kind of argument replies and replies upon replies, and as infinite a contexture of debates as our wrangling lawyers have extended in favour of long suits, the reasons have little other foundation than experience, and the variety of human events presenting us with infinite examples of all sorts of forms”<sup>3</sup>. Apparently, in those years, Horkheimer already fully appreciated the depth of Montaigne’s remark – in fact skepticism, driven to the limit, degenerates into its opposite. But it is curious what

---

<sup>3</sup> Montaigne, M. *The Essays of Mantaigne, complete*. Cit.: <<http://www.gutenberg.org/files/3600/3600-h/3600-h.htm>>.

Horkheimer puts as the border of skepticism. According to him, modern skepticism has undergone significant changes. Its commitment to conformism is conditioned by the economic influence of an epoch. In the epoch of Horkheimer's "Self", which is based on the freedom of the individual, maintains its independence in society only as a subject of economics, taking part in the whole process of economics. In this skepticism is ready to admit the freedom of each individual, unless it interferes with the economic and political processes. That is, the real participation in social, political and economic processes envelops skepticism. Actually, this shows Horkheimer's commitment to dialectic tradition: skepticism is necessary for the participation in the processes of the real social and political life be conscious, and at the same time, it is the participation in the processes of the real life that puts limits to skepticism.

Thus, the "method of doubt" of Descartes and "skeptical doubt" of Montaigne are the philosophical bases of the historical method of M. Horkheimer's critical theory of society. Appeal to the rationalistic origins of the European tradition gives philosophical foundation to the critical theory of society.

## VIII. HISTORY OF WORLD CONGRESSES OF PHILOSOPHY

*T. Shchedrina*

### **PHILOSOPHICAL CONGRESS AS A PHENOMENON OF CULTURAL-HISTORICAL COMMUNICATION<sup>1</sup>**

Modern technical means of communication have intensified and synchronized the ties between the philosophical and scientific communities so much that today we can really talk about the creation of “global” philosophical community, having its own specific ways of functioning, rather complex multibranch structure and specific forms of display: internet conferences, teleconference, internet forums etc. But in due time The First World Congress of Philosophy played a special role in the formation of global philosophical community. The thing is that this form of communication is based on the direct contact and therefore allows the revealing of existential aspects of philosophical topics. These aspects are generally not disclosed in impersonal communication. The study of such cultural and historically conditioned communicative links and relationships, existing in philosophical community, allows not only to reconstruct the personal context of its formation within a particular era, but also to demonstrate the cultural-historical conditionality of contemporary philosophical subjects.

I should note that cultural-historical conditionality is significantly different from social conditionality (this aspect is investigated today as part of “social epistemology”). In the researches of social epistemology there is a rigid semantic boundary between philosophical activities, connected with personal reflection and expression of thought

---

<sup>1</sup> This article has been prepared with the financial support of the grant RFH No. 13-33-00336.

about reality, and social activities, involving external structuring (institutionalization) of philosophical community. If “social epistemology” seeks to examine the economic situation of a philosopher, his social origins, the place of education, membership in a particular social group and political organization, and then by these parameters to analyze its mode of expression (discourse) and to create a discursive typology of “philosopher” as a social type, cultural-historical epistemology chooses the other way. It explores not discourse itself, but discourse as semiotic phenomenon rooted in the existential traditions of direct communication, where the boundary between the individual and sociality is erased. The fundamental role in cultural-historical epistemology plays “the archive of an epoch”, making studies of “minor” archive materials. Drafts, notes, diaries, epistolary heritage have existentially coloured, publicly unspoken thoughts, notes, phrases, evaluation, personal relations of philosophers, what is especially valuable for cultural-historical research.

Cultural-historical perspective on The First Congress of Philosophy helps to reveal the existential foundation of philosophical dialogue, to understand its sign-symbolic meaning and specificity. After all, as H. Bergson once said – the member of this philosophical congress – before the Congresses the communication of philosophers and their knowledge of each other was clearly insufficient, and in this sense they were a little bit like Leibniz’ monads.

In order to identify existential potential of philosophical congress as a form of communication, it is necessary to reconstruct its thematic structure through the dynamics of its preparation. This approach involves first of all the analysis of the personal and existential aspects of communication in congress (and in the process of its preparation) that can be reconstructed, relying on not so much the finished (prepared) policy documents of the congress, the published papers of the participants, reviews and other work materials, but rather on pre-congress business and personal correspondence of organizers, containing an outline of thematic structure of the congress, the discussion of sectional division, the invitation of members of the congress, the choice of priority figures for plenary sessions. Of particular importance in this respect is the correspondence with foreign philosophers.

I want to notice that the epistemological significance of this aspect today is the least understood and that is why it requires the introduction of unexplored archive materials in scientific circulation, clarifying the cultural-historical meaning of The First Congress of Philosophy. These include the manuscripts from the personal funds of the organizers of The First Congress of Philosophy (K. Leon, A. Lalande, E. Halevi and others), their Russian correspondents-philosophers (N. Lossky, V. Ivanovsky, N. Vasilyev and other) and the funds of scientific and philosophical institutions. Here I focus only on one aspect of cultural-historical research “The First Congress of Philosophy”. It is important to me, what impact this congress had on Russian philosophical and humane “sphere of conversation”, what consequences it had for the communication of Russian philosophers (the members of Congress) on the formation of professional philosophical community in Russia.

The study of a significant body of archive materials allows me to conclude that the communication of Russian philosophers on Congress, their correspondence (before and after the Congress) with European philosophers and involvement in European philosophical life have shaped Russian philosophical community, its thematic priorities, problem areas and on the formation of philosophical terminology. Let me explain this with an example of life of one Russian participant of The First Congress of Philosophy – Vladimir Nikolaevich Ivanovsky.

Terminology work was always included in the sphere of philosophical interests of V. N. Ivanovsky. It was at The First International Congress of Philosophy, where he made the report “Sur la possibilité d’une terminologie philosophique commune pour tous les philosophes (13 question de Votre programme de Philos. Gener. Et Metaphysique) – principalement dans la logique et dans la psychologique”<sup>2</sup>, and then with A. Lalande he worked on famous dictionary «Vocabulaire technique et critique de la philosophie», which has not lost its relevance today. Congress, in fact, was the catalyst for philosophical interest in terminology

---

<sup>2</sup> A letter from V. N. Ivanovsky to K. Leon, December 14/26, 1899, in: *Archives de la Sorbonne. Fond X. Léon. FB669. f. 143–144*. Letters from V. N. Ivanovsky to G. G. Shpet and the paper by Ivanovsky on philosophical terminology will be published in full in vol.9 of the collected edition of G. G. Shpet “The Philosopher in Culture: Documents and Letters”, Moscow, ROSSPEN, 2012 [in Russian].

work (and not only in Russia, but also in other European countries). The evidence of this fact is the correspondence of A. Lalande with K. Leon, Ed. Claparede, Vl. Ivanovsky, A. Lemaitre etc.

Ivanovsky indicated his interest in the terminology problems in a letter to the organizer of “The Institute of Scientific Philosophy” Gustav Gustavovich Shpet in 1922. “Having been interested for a long time in the problems of philosophical terminology, – he wrote – I came to the conclusion that many misunderstandings in philosophy and many difficulties of its learning depend on the obscurity of its terminological side, on inattention to it, that the correct formulation of the scientific-philosophical education and a strong orientation in philosophy depend on the clarity of the basic concepts and terms, I read at the First International Congress of Philosophy in Paris in 1900 a report on the program theme, partly coming into contact with the problem which interested me: Sur la possibilité d’une terminologie commune à tous les philosophes, which briefly develop my point of view. (A brief summary of my report is placed in the record of congress in *Revue de métaphysique et de morale*, 1900). On the behalf of Congress Organizing Committee the rapporteur on this issue was professor Andre Lalande, by the proposal of whom Société Française de philosophie, which was formed after the congress, began publishing *Vocabulaire philosophique*. The main objective of *Vocabulaire* was criticism and selection of the most appropriate, in colleagues’ judgment (Lalande, Couture, Belau, Brunshvik and others), meanings of French terms, and the record of term meanings in other languages and in different philosophical schools was put to the sidelines. Being invited to the *Vocabulaire*, I was giving in my small articles the reviews of the term meanings in the way in which I bring them forward to the attention of Terminology Commission”<sup>3</sup>. Ivanovsky was also reporting about the results of his terminological research at The Second International Congress of Philosophy (Genève, 1904), the evidence of it is his letter to the organizer of this event Edward Claparede<sup>4</sup>.

---

<sup>3</sup> The paper by full-fledged member of the Institute for scientific philosophy at the faculty of social sciences of the Moscow University. May 15<sup>th</sup>, 1922, in: *A letter from V. N. Ivanovsky to G. G. Shpet*. Department of manuscripts of the State Russian Library. 718-24-53 [in Russian].

<sup>4</sup> *A letter from V. N. Ivanovsky to Éd. Claparède*. <1905> Bibliothèque publique universitaire à Genève (further: BPU. – T.S.). Ms. fr. 4013. Éd. Claparède. f. 51 a [in Russian].

The tradition of terminology research, with which Ivanovsky became familiar while working for The First Congress of Philosophy and working on “Technical and critical dictionary of philosophy” (directed by A. Lalande), was directing his philosophical work in the first years of Soviet government, in the years of new ideological forms establishment. Philosophers, who remained in Russia, were trying to make this ideology “scientifically” and “philosophically” oriented. The experience of communication with their European colleagues (including the philosophical congresses) taught them to do that. The elaboration of generally valid language of the humane studies depended on the formation of philosophical terminology, and these studies were directing the worldviews of cultural-historical consciousness of the Soviet Union people. Ivanovsky formulates the following methodological opportunities of research in philosophical terminology: 1) “the establishment of the history of terms themselves” and 2) “the analysis of the history of concepts and their development in a number of terms, different in different times and in different nations”, and 3) “the elaboration of normal, so to speak, system of terms, selection from them of the one most appropriate” and 4) “the study, which would come from actually used terms of their own, native language, and would establish their origin and their connection with the variety of concept notions in different peoples, at different times, in different scientific philosophical schools<sup>5</sup>”. Consequently, each time, depending on the context the researcher can choose the most appropriate basis for the consideration of specific words-concepts. In the terminology work, set by The Institute of Scientific Philosophy, Ivanovsky suggested being guided by the fourth opportunity and he justifies his choice with the fact that “such a study would give as a general pattern of work the system of terms of own language and would use the collective, the world’s supply of ideas for the benefit primarily of native home scientific-philosophical thought<sup>6</sup>”.

V. Ivanovsky not only reveals the methodological possibilities and ways of historical study of philosophical word-concepts, but also presents specific examples of such work. These are drafts of encyclopedic articles for “Dictionary of philosophical terminology”. I should note that

---

<sup>5</sup> *A letter from V. N. Ivanovsky to Éd. Claparède.* <1905> Bibliothèque publique universitaire à Genève (further: BPU. – T.S.). Ms. fr. 4013. Éd. Claparède. f. 51 a [in Russian].

<sup>6</sup> Ibid.



in their methodological orientation terminology works of Ivanovsky in fact anticipated the works of R. Kozelik on the “history of concepts”. I believe that the study of the dynamics of terminological priorities through the documents of “the archive of an epoch” will allow us today to understand in many new ways the current situation of the forming of world philosophical community. It is important to follow the dynamics of research of communication links of philosophical communities in Russia and in Europe, what is not possible to do without personal contacts with the scientists. The role of the philosophical congresses in the origination of such contacts is difficult to overestimate.

## AUTHORS

- Apresyan R.* – DSc in Philosophy, Head of the Department of Ethics
- Artemyeva O.* – PhD in Philosophy, Senior Research Fellow, Department of Ethics
- Avtonomova N.* – DSc in Philosophy, Main Research Fellow, Department of the Theory of Knowledge
- Beskova I.* – DSc in Philosophy, Leading Research Fellow, Department of Evolutionary Epistemology
- Chumakov A.* – DSc in Philosophy, Leading Research Fellow, Centre for Bio- and Ecophilosophy
- Dolgov K.* – DSc in Philosophy, Main Research Fellow, Department of Aesthetics
- Fedotova V.* – Professor, DSc in Philosophy, Head of the Department of Social Philosophy
- Gadzhikurbanova P.* – PhD in Philosophy, Senior Research Fellow, Department of Ethics
- Gorokhov V.* – DSc in Philosophy, Main Research Fellow, Department of Interdisciplinary Problems in the Advance of Science and Technology
- Guseynov A.* – Professor, DSc in Philosophy, Full Member of the Russian Academy of Sciences, Director of the Institute of Philosophy of the Russian Academy of Sciences
- Kanaev I.* – PhD in Philosophy
- Kasavin I.* – DSc in Philosophy, Corresponding Member of the Russian Academy of Sciences, Head of the Department of Social Epistemology
- Kasavina N.* – PhD in Philosophy, Senior Research Fellow, Centre for the Study of Social and Cultural Change
- Korolev A.* – PhD in Philosophy, Research Fellow, Centre for Bio- and Ecophilosophy
- Kravchenko A.* – Post-graduate Student, Department of Ethics
- Lebedev A.* – PhD in Classical Philology, Leading Research Fellow, Department of the History of Western Philosophy
- Lektorskiy V.* – Full Member of the Russian Academy of Sciences, DSc in Philosophy, professor, Head of the Department of the Theory of Knowledge

*Liseev I.* – DSc in Philosophy, Main Research Fellow, Head of the Centre for Bio- and Ecophilosophy

*Mamchur E.* – DSc in philosophy, Head of the Department of Philosophical Problems in Natural Science

*Morkina J.* – PhD in Philosophy, Senior Research Fellow, Department of Evolutionary Epistemology

*Pavlov S.* – PhD in Philosophy, Senior Research Fellow, Department of the Theory of Knowledge

*Pronin M.* – PhD in Medicine, Senior Research Fellow, Department of Humanitarian Expertise and Bioethics

*Pruzhinin B.* – DSc in Philosophy, Leading Research Fellow, Department of the Theory of Knowledge

*Sabancheev R.* – Student, Faculty of Philosophy, State Academic University for the Humanities (GAUGN)

*Sharova V.* – PhD in Political Science, Research Fellow, Department of the Philosophical Problems of Politics

*Shchedrina I.* – Student, Faculty of Philosophy, State Academic University for the Humanities (GAUGN)

*Shchedrina T.* – Professor, Department of Philosophy, Moscow State Pedagogical University (MPGU)

*Shchedrovitsky P.* – PhD in Philosophy, Deputy Director for Development of the Institute of Philosophy of the Russian Academy of Sciences

*Shevchenko V.* – DSc in Philosophy, Head of the Department of the Philosophical Problems of Politics

*Shushkina A.* – Student, Faculty of Political Science, State Academic University for the Humanities (GAUGN)

*Smirnova N.* – DSc in Philosophy, Leading Research Fellow, Department of Evolutionary Epistemology

*Stepanyants M.* – DSc in Philosophy, Head of the UNESCO Chair “Philosophy in the Dialogue of Cultures”, Main Research Fellow, Department of Oriental Philosophies

*Stepin V.* – Professor, DSc in Philosophy, Full Member of the Russian Academy of Sciences, Full Member-secretary of Branch for RAS, Honorary Doctor of Karlsruhe University (Germany), Honorary Director of the Institute of Philosophy of the Russian Academy of Sciences

*Trufanova E.* – PhD in Philosophy, Senior Research Fellow, Department of the Theory of Knowledge

*Yakovleva A.* – PhD in Political Science, Senior Research Fellow, Department of the Philosophy of Russian History

*Yudin B.* – DSc in Philosophy, Corresponding Member of the Russian Academy of Sciences, Professor, Main Research Fellow, Department of Humanitarian Expertise and Bioethics

*Zubets O.* – PhD in Philosophy, Senior Research Fellow, Department of Ethics

Научное издание

## **Philosophy: Theory and Practice**

*Утверждено к печати Ученым советом  
Института философии РАН*

Художник *Н.Е. Кожина*

Технический редактор *Ю.А. Аношина*

Корректурa авторов

Лицензия ЛР № 020831 от 12.10.98 г.

Подписано в печать с оригинал-макета 16.12.13.

Формат 60x84 1/16. Печать офсетная. Гарнитура Times New Roman.

Усл. печ. л. 17,0. Уч.-изд. л. 14,02. Тираж 500 экз. Заказ № 048.

Оригинал-макет изготовлен в Институте философии РАН

Компьютерный набор авторов

Компьютерная верстка: *Ю.А. Аношина*

Отпечатано в ЦОП Института философии РАН

119991, Москва, Волхонка, 14, стр. 5

Информацию о наших изданиях см. на сайте Института философии:  
<http://iph.ras.ru/arhive.htm>

<http://eng.iph.ras.ru>

<http://eng.iph.ras.ru>

<http://eng.iph.ras.ru>